

Educational Software Makes the Grade

MICROCOMPUTING[®]

A WAYNE GREEN PUBLICATION

September 1982
USA \$2.95 (UK £1.80)
Number 69

The Shapes To Come:

Shirt-pocket Floppies

8/16-bit Micros

Portable
Computers



me to the
Room

AUG 83

e, Atari,
lore,



From Percom... System-50 Summer Save-On Sale!

Save On LFD First-Drive Systems – Proven clock-data separation circuitry and other superior design features • Reliable hard-sector diskette formatting • Stores up to

102 Kbytes of formatted data on 40 tracks • Complete with drive (or drives), S-50 4-drive controller, MPX or MPX/9 DOS, interconnecting cable and users manual. While they last...

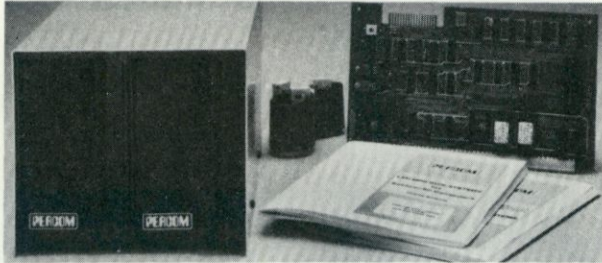

40-Track, one-drive, non-flippy	now \$384.95	Save \$ 75
40-Track, one-drive, floppy	now \$399.95	Save \$100
80-Track, one-drive, non-flippy	now \$520.95	Save \$100
80-Track, one-drive, floppy	now \$560.95	Save \$100
LFD 4-Drive Controller (only)	now \$ 95.00	Save \$ 20
2-Drive Interconnecting Cable (only)	now \$ 19.95	Save \$ 10
3-Drive Interconnecting Cable (only)	now \$ 29.95	Save \$ 5

First-Drive Systems are also available in 2- and 3-drive versions. Save even more!

Save On Single-Board Computer/S-50 MPU Card now \$119.95 **Save \$20** The SBC/9 is a computer or a fully compatible SS-50 bus MPU card • Interchangeable 6802 or 6809 processor • Extendable 1-Kbyte ROM monitor • Parallel and serial I/O ports –selectable, full-range bit rate generator for serial I/O • Extendable addressing • On-card 1-Kbyte RAM • Provision for additional EPROM • On-card voltage regulator circuits.

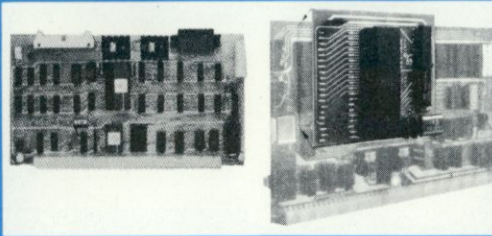

Save On 6809 MPU Upgrade Adapter now \$31.95 **Save \$8** Upgrades 6800 MPU cards to 6809 processing power. Configured for SWTP MP-A2 MPU card but may be used with other MPUs. Plug-in installation requires no trace cutting or soldering –easy to restore MPU to original configuration. Assembled and tested. Includes user instructions. 6809 ROM operating system, PSYMON/A2, for use with the 6809 MPU Adapter –\$69.95.

Save On Memory-Mapped Video Display Generator Controllers...

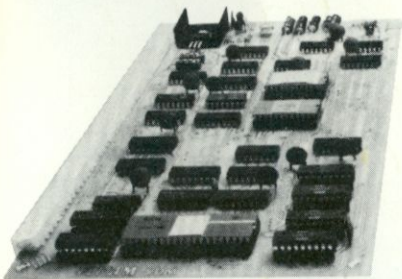

The **Electric Window** features software-defined display formats, expandable 128-unit character generator, fully formed characters, composite or separate sync-video output. now \$119.95. **Save \$50.**

The **ColorAMA-50** features up to 8-color displays and 256 x 192 pixel resolution (with full display RAM), extended 1-Mbyte addressing capability, provision for audio cassette I/O and low cost rf modulator for TV displays, comprehensive manual with 6809 driver listing. Now \$94.95 with 1K display RAM. **Save \$45.** Additional display RAM \$19.95/Kbyte. **Save \$10.**



Save On Dual Serial I/O Card now \$54.95. **Save \$20.** This two-channel RS-232 data communications interface features an on-card bit-rate generator (BRG) (ideal for extended addressing bus) that generates seven standard rates from 110 b/s to 19,200 b/s, individually selectable TX/RX

rates for each channel, compatibility with older and newer versions of 30 pin I/O bus and either 16- or 4-byte boundary addressing. Note: Shown with optional port connectors, configuration switches and BRG installed. Also available without BRG for \$49.95. **Save \$10.**

Save On Rock Solid RAM Cards now \$94.95. **Save \$45.** Includes 8K of RAM, expandable to 24K. Each 8K block may be located at any 8-Kbyte boundary of 64K address space. Other features: 1-Mbyte extended addressing, buffered data, address and control lines, comprehensive manual with diagnostic memory test programs. Eight-Kbyte RAM kit –now \$49.95. **Save \$40.**

Versatile Prototyping Boards, Extendable Motherboards

50-pin Motherboard/Extender Board (7-slot)	\$21.95
I/O Motherboard Kit (8-slot)	\$44.95
S-50 Bus Protoboard	\$24.95
I/O Bus Protoboard	\$14.95

ColorAMA-50, Electric Window, SBC/9, PSYMON and PERCOM are trademarks of Percom Data Company, Inc.

PRICES & SPECIFICATIONS SUBJECT TO CHANGE WITHOUT NOTICE.

As near as your telephone – You can save on the lowest prices ever for these quality Percom products by calling toll-free 1-800-527-1222 (from in Texas call 214/340-7081). Don't wait! At these prices we cannot guarantee product inventories.

PERCOM

PERCOM DATA COMPANY, INC.

11220 Pagemill Road • Dallas, Texas • 75243

214/340-7081

Sell! Stop Training!

DEALERS:

Add a **CUSTOMER SUPPORT** department to your store. Use your time for **SELLING** not **TEACHING!** Your customers will have their new computer up and operating the day of purchase! **END** the **USER MANUAL MYSTERY**, stock **MICRO** Instructional tapes!

One hour of easy listening replaces all the confusing written manuals usually required to begin. You can **KNOW** for certain that your customers will quickly apply the programs you sell to their business! **WORDSTAR**, **DATASTAR**, **SUPERSORT**, **SUPERCALC** are all within the realm of understanding and fast application. Customers won't be taking up your time with minute questions. They will be back to purchase other hardware, software and accessories...**NOT TO ASK IF ANYONE KNOWS HOW TO USE THE PROGRAM!** Your time can best be applied **SELLING**, **NOT TRAINING!** Yet, your customers expect support and assistance with difficult to understand programs. Few business people appreciate the time they may have to spend in their offices training a secretary or bookkeeper...yet someone has to do the job.

Your profits can be increased by not having to spend time teaching your customers how to use hardware or software. Since you put your reputation on the line if the products don't perform to expectation, some dealers are using our taped series as a way of saying "THANK YOU" to customers for their purchase of a system or software. Don't overlook the power of our instructional tapes for training your own personnel. New employees may have to study many manuals and their level of bewilderment will be no less than that of your customers.

Available nationwide at "The Xerox Stores" and other selected dealers.

MOST PRICED UNDER \$40

These "plain language" condensed user's manuals are available now in standard audio cassette. Many others are being developed and will soon be available...

Systems	Software	Software	Software
Apple II+ ¹	Calcstar ¹²	Mailmerge ¹²	Visicalc ¹¹
H/Z-89 ²	dBase II ⁶	Power Text ⁴	Visifile ¹¹
IBM-PC ³	Datastar ¹²	Spellguard ⁹	Visidex ¹¹
Osborne 1 ⁴	Exec Sec'y ¹³	Supercalc ¹⁰	Wordstar ¹²
Xerox 820 ⁵	Magic Wand ⁷	Supersort ¹²	

© Copyright 1982 MICRO Instructional Inc.

TRADEMARKS OF: 1. Apple Corp.; 2. Heath Company/Zenith Radio Corp.; 3. IBM Corp.; 4. Osborne Computer Corp.; 5. Xerox Corp.; 6. AshtonTate; 7. Peach Tree; 8. Beaman-Porter; 9. Innovative Software Applications; 10. Sorcim; 11. Visicorp; 12. MicroPro Int. Corp.; 13. Sof/Sys.

CALC-PLUS™

Expand your **BUSINESS** application of
Calcstar™, **Supercalc™**, **Visicalc™**

Priced at only **\$169.⁹⁵**

Calc-Plus™ has been designed to compliment your electronic spreadsheet programs, **CALCSTAR™**, **SUPERCALC™** or **VISICALC™**. These accessory programs are ideal for business use where the user either lacks the technical training to develop such an application or simply does not have the time to do so.

The small office user will find that his secretary or bookkeeper can quickly apply these programs for entry of checking account data and easily handle bank reconciliation and account distribution. Two formats permit calculation of wages for salaried and/or hourly workers. Calc-Plus™ **Payroll** requires very few manual entries. Individual hourly rate is entered only at the beginning of the pay period. Daily hours and Federal Income Tax are entered. Gross, F.I.C.A. and Net are calculated automatically. An individual earnings record may be printed to accompany the check.

Other Calc-Plus™ enhancements include **Depreciation, Accounts Receivable, Accounts Payable, Cash Receipts and Cash Disbursements.**

Mount on a second drive and load to Supercalc, Calcstar or Visicalc. Available in 5" and 8" formats for most popular computer systems.

Financial Overlay with Audio Instructions copyright 1982
MICRO Instructional Inc.

Trademarks of MicroPro International Corp. Sorcim Corp. Visicorp

INSTRUCTIONAL INC

6299 W. SUNRISE. FT. LAUDERDALE. FL 33313. (305) 584-3133

M
I
C
R
O

NEW!



Kiss the 5¼" floppydisk goodbye!

Amdek has revolutionized data storage for personal computers with the new AMDISK-3 Micro-Floppydisk drive system. The system consists of 2 drives and a power supply, fully compatible with 5¼" floppy disk drives. The 3" disk is encased in hard plastic, protected from dust and fingerprints, and it's easy to mail.

Just write, or call to receive our data sheet on the new AMDISK-3 Micro-Floppydisk Cartridge system.

- 1 Megabyte (unformatted) storage capacity.
- Track-to-track compatible with 5¼" floppy-disk drives.
- 3" shirt-pocket sized disk cartridge.
- Drive has built-in power supply.

2201 Lively Blvd. • Elk Grove Village, IL 60007
(312) 364-1180 TLX: 25-4786

AMDEK CORP.

Amdek . . . your guide to innovative computing!

Circle 96 on Reader Service card.

MICROCOMPUTING

Contents: September 1982
Volume VI No. 9

PUBLISHER/EDITOR
Wayne Green
EDITORIAL MANAGER
Jeff DeTray
MANAGING EDITOR
Dennis Brisson
COPY EDITOR
Linda Stephenson
EDITORIAL ASSISTANTS
Larry Canale, Daniel Muse
TECHNICAL EDITORS
Jake Commander, G. Michael Vose
PRODUCTION EDITOR
Susan Gross
ADMINISTRATIVE ASSISTANT
Michele Christian
ASSOCIATE EDITORS
Robert Baker, Frank Derfler, Jr.,

PRODUCTION MANAGER
Nancy Salmon
ASSISTANT PRODUCTION MANAGER
Michael Murphy
ADVERTISING PRODUCTION
Bruce Hedin, Steve Baldwin, Fiona Davies, Jane Preston
PRODUCTION DEPARTMENT
Joan Ahern, Frances Benton, Linda Drew, Bob Dukette, Phil Geraci, Susan Hays, Louis Marini, Theresa Ostebo, Scott Philbrick, Dianne Ritson, Mary Seaver, Deborah Stone, Anne Vadeboncoeur, Irene Vail, Judi Wimberly, David Wozmak
PHOTOGRAPHY
Thomas Villeneuve, Sandra Dukette, Bryan Hastings Elizabeth Libby, John Schweigert, Robert Villeneuve
TYPESETTING
Sara Bedell, Marie Barker, Melody Bedell, Michele DesRochers, Jennifer Fay, Lynn Haines, Debra Nutting, Anne Rocchio, Ellen Schwartz, Karen Stewart
DESIGN
Denzel Dyer, Howard Happ, Laurie MacMillan, Joyce Pillarella, Susan Stevens, Donna Wohlfarth

EXECUTIVE VICE PRESIDENT
Sherry Smythe
GENERAL MANAGER
Debra Wetherbee
CONTROLLER
Roger Murphy
ASSISTANT TO THE PUBLISHER
Matthew Smith
ACCOUNTING MANAGER
Knud Keller
CIRCULATION
603-924-9471
Pat Ferrante
BULK SALES MANAGER
Ginnie Boudrieau
DIRECTOR OF ADVERTISING
David Schissler
ADVERTISING
603-924-7138

Louise O'Sullivan, Beverly Poirier, Giorgio Saluti
NEW ENGLAND ADVERTISING REPRESENTATIVE
John A. Garland
Jack Gardner
Garland Associates, Inc.
Box 314 SHS
Duxbury, MA 02332
617-934-6464 or 6546

On the cover: New developments which came out of the National Computer Conference showed a trend toward smaller, higher-density disks; micros with dual processors that can read both 8-bit and 16-bit operating systems; and more easily transported micros for the microcomputerist on the move. These trends are reflected in the products shown on the cover (from top): a three-inch Micro Floppydisk marketed by Amdek Corporation, North Star's 8/16 Computer and the portable Kaycomp II microcomputer system. *Microcomputing's* report on the NCC begins on page 38.



Class of '82 Lloyd Prentice.....	32
Educational software graduates earned some high marks.	
Micros on Campus Thomas Madron.....	36
Plan now for their arrival; don't be caught by surprise.	
Future Trends Take Shape at NCC Frank Derfler.....	38
Look for more powerful, more portable micros.	
Atari in Wonderland Dietmar May.....	50
This trip through the looking glass doubles your Atari RAM. Atari	
Everything You Need on a Single Board Terry Kepner.....	58
Colonial Data Systems' SB-80 is loaded with features. SB-80	
Micro Money-Maker Joseph Najjar.....	62
Understand your future financial value. TRS-80	
The One Printer Solution	70
Centronics' Printstation 350 Series answers office needs.	
Beyond 64K for the Apple Donald Black.....	74
Memory to spare from Saturn Systems. Apple	
A Number Pad for Apple II Users James King.....	80
Save time entering data with this simple number pad. Apple	
The Portable Atari Marvin Shuldman.....	84
Make your Atari a little easier to use and carry around. Atari	
Black Friday Robert Baker.....	88
Buy and sell on the stock market without losing your shirt. Commodore, Atari	
★Duelling Joysticks Russell Grokett.....	100
Add two more joysticks to your VIC. VIC-20	
A Quick and Dirty Input Port Ladimer Nagurney.....	110
Add another input port to a single board computer.	
★Designated for The Game Room	

Publisher's Remarks—6 **Micro Software Digest—24** **Book Reviews—134**
Micro Quiz—7 **★Micro Game Digest—96** **New Products—138**
PET-pourri—8 **Dealer Directory—103** **New Software—148**
What's New, Big Blue?—12 **Classifieds—103** **Calendar—152**
Letters to the Editor—16 **★Game Reviews—104** **Software Reviews—162**

War Declared On Software Thieves!



The \$2,000,000,000 Theft!

That's right, the estimates for software theft for this year are now running to about \$2 billion!

Software manufacturers are well aware that their programs are being stolen . . . massively stolen. But since there are no good answers to the problem, they have been trying to live with the disaster. Recent Instant Software estimates of theft indicate that approximately 90% of the Instant Software programs in the hands of users are stolen. Since Instant Software has, for the most part, been dealing with lower priced programs, and these have been particularly prone to theft, it is estimated that Instant Software alone will lose something over \$30,000,000 in sales this year as a result of program theft.

How are the programs being stolen? Some are being copied for friends by buyers of the program. We have gotten reports of large scale copying of programs by dealers anxious to add something to promote a computer sale. Then there are the user's groups, where often the major activity of the group is the exchange of programs. One chap wrote a few days ago to brag that he had so far managed to copy over \$100,000 worth of programs as part of his local user's group's activities.

While some summer camps make an effort to keep program copying to a minimum, this is almost impossible to monitor. It only takes seconds to copy a whole disk full of programs . . . and minutes to copy many disks of programs. A camper wrote to say that within the first two days of camp he had gotten copies of 2500 programs . . . and that he was having to buy a lot more disks just to make copies from other campers. The kids often bring boxes of disks, full of stolen programs, for swapping.

If one is practical about this, it is kind of stupid to pay for a program when you can steal it . . . and there is no way of getting caught or getting into trouble. I'm not aware of any user ever being brought to justice for program copying. Sure this is illegal, but without any punishment what does "illegal" mean?

There is a need, some feel, for a crackdown on software theft if we are going to see much in the way of significant software developed. Programmers are not

One chap bragged
that he had copied
over \$100,000 worth
of programs
A camper had copied
2500 programs
within the first
two days of camp.

going to work for peanuts forever, nor are entrepreneurs going to continue trying to market low cost software if they are not able to get any return for their investment and work. But how can there be a crackdown on the friend who gets a copy of programs? How can user clubs be stopped from promoting million dollar thefts? How can computer stores be stopped from giving away hundreds or even thousands of dollars in software in order to promote computer sales?

Perhaps it is time for some sort of "sting" operation . . . or even a group of them. If one computer store that is part of a chain were to be caught in program theft, it might be possible for the software manufacturers to bring a suit against the headquarters and all of their stores—and that could be a billion dollar suit.

A sting operation against a user's group might enable the software manufacturers to bring a suit against the club and every one of its members, again with figures in the millions of dollars. Yes, it is unfair for some club member who has a lot of assets to be singled out and stripped clean in such a suit, but one has to admit that a few cases like that might bring many computerists to their senses; it might make them wonder, next time someone asks them to run off a program copy, whether the copy is what is wanted . . . or grounds for a lawsuit.

Instant Software took the lead in this field by offering a \$10,000 reward for anyone who helped them get a conviction for copying an Instant Software program. This offer still holds, but apparently \$10,000 just isn't a lot of money these days because no one has yet come forth with any incriminating evidence.

Wayne Green Publications will be taking a position of leadership in this matter. The first step is toward getting cooperation from other software firms to provide a more significant reward. It is hoped to bring this kitty up to \$100,000 in cash for the conviction of someone copying a copyright program. Perhaps this kind of money will succeed where the mere \$10,000 failed. The industry would get millions of dollars worth of publicity out of it if they are able to bring off a conviction.

Even a couple of good convictions won't entirely stop program theft, but the obvious fact that this is not only illegal, but a crime that is punishable, should

prevent all but the most foolhardy from further thefts. This could easily cut program theft by 75 percent, saving the industry over a billion dollars in lost sales. Good investment.

Yes, I realize that it is unfair to add up the retail prices of stolen programs and think for a moment that the computerists who have stolen them would ever buy all of them. We don't know what the real industry sales would be if people who really wanted the programs had to buy them. We do know that every time a new program is brought out it sells for a few weeks and then sales dwindle off. We also know that the computerist who gets copies of 3000 programs is not going to be able to ever use even a fraction of them. We therefore know that the few programs they are using were probably stolen and otherwise would have brought income to software firms, dealers and programmers.

Taking all of these variables into consideration, my calculations show that software retail sales would be increased by a factor of about five if it were not for program theft. Popular programs should have a life in stores of a year or two, not weeks.

Not untypical is the story of one of the major Instant Software dealers in New York City. He complained that a local store of a large chain sent someone in every few days to look over new programs released by Instant Software. One copy is bought and then this is copied and sent to every store in the chain in the area. From there copies are made for computer buyers and friends of the store salesmen and managers. The dealer estimated that every program bought by this one store resulted in several thousand free copies. . . and just about killed all further sales of the program for him.

In the next few weeks we will be organizing the software firms for an aggressive attack on this problem. If any of you readers are interested in working with the association in setting up a sting operation, you might drop me a line and tell me what you have in mind. □

MICRO QUIZ

Analysis of Algorithms

How many times is "MICRO" printed during the execution of the following program?

```

N = 4
FOR I = 0 TO N - 1
  FOR J = J + 1 TO N
    PRINT "MICRO"
  NEXT J
NEXT I
    
```

(answer on page 15)

Leap into a new dimension



with Aztec C II

MANX

C COMPILERS - COMMON FEATURES:

- UNIX VER 7 compatibility • standard float, double, and long support • run time library with full I/O and source • fast compilation and execution • full language.

AZTECC II CP/M HEATH HDOS \$199

- produces relocatable 8080 source code • assembler and linker supplied • optional M80 interface • SID/ZSID debugger interface • library utility • APPLE requires Z80 and 16K card

AZTECC II APPLE DOS \$199

- relocating assembler supplied • APPLE SHELL•VED editor • library and other utilities • requires 16K card

C86 IBM PC MSDOS CP/M-86 \$249

- directly produces 8088/8086 object code • linker supplied

Manuals — \$30

ORDER BY PHONE OR BY MAIL - Specify products and disk format



CP/M FORMATS: 8"STD, HEATH, APPLE, OSBORNE, NORTHSTAR...
OUTSIDE USA - Add \$10 In N.J. add 5% sales tax

MANX
software systems

Box 55, Shrewsbury, N.J. 07701
(201) 780-4004

Circle 295 on Reader Service card.



Save Time • Save Money
Save Disk Storage Space
Now you can convert an entire box of 10 disks quickly and safely in just minutes.

You will pay for this kit in added disk space with the first box of disks you convert.

Disk Doubler for 5 1/4 inch disks.
Use both sides of your single sided disks.

Disk Doubler II for 8 inch disks.
Use single sided disks either as two sided or double sided depending on your disk drives.

Disk Doubler—\$8.95 postpaid
(in U.S.) [CA residents add 54% tax]

Disk Doubler II—\$12.95 postpaid
(in U.S.) [CA residents add 78% tax]

Overseas customers write for shipping charges.
Send your check or money order today and start saving money.

JIM QUINN
Computer Division
9120 CLEARLAKE WAY
LAKESIDE, CA 92040

Circle 189 on Reader Service card.

TRS-80*

SAVE A BUNDLE

When you buy your TRS-80™ equipment!
Use our toll free number to check our price before you buy a TRS-80™ . . . anywhere!

TRS-80 is a trademark of the Radio Shack Division of Tandy Corporation

Don't Delay. . Call Today



SALES COMPANY

704 W. MICHIGAN AVE.
P.O. BOX 8098 PENSACOLA FL 32505

904/438-6507

nationwide 1-800-874-1551

Commodore Gets Smart

With Terminal Communications Package

STCP

STCP is a Standard Terminal Communications Package for Commodore computers, developed jointly by Eastern House Software and CGRS Microtech. The package includes the necessary hardware and software to drive RS-232-type modems on a Commodore PET/CBM system. Thus you have a wider selection of modems over the IEEE variety, from the inexpensive Signalman modem to the auto-dialing D.C. Hayes Smartmodem.

The hardware portion of STCP is the Portmaker board from Microtech. This board normally provides two RS-232 serial ports via standard 6850 ACIAs. It plugs into one of the spare ROM sockets of your Commodore system—UD4 or UD11, depending on your machine type. Two small clips then connect to one of the expansion connectors (J9) on the system PC board. Installation is quick and easy with no special tools or soldering required.

If you originally had a ROM in the required socket in your system, you can now install it on the Portmaker board. The only restriction is that the last 16 bytes of the ROM are no longer accessible, since this is where the ACIA chip is now located.

The STCP program is 100 percent machine language and about 6K in length. A single Basic starter program is also included to load and configure the STCP software. As supplied, this software package turns your Commodore system into a sophisticated smart terminal. It can also be used as a handy utility for converting disk files from one format to another.

The STCP program is normally run independently, but can be controlled by another machine-language or Basic program. A number of entry points and important locations are described in the

documentation. A sample program is included on the disk to illustrate how you can control STCP from another program. Thus you could easily create your own bulletin board system.

As a terminal the system can operate in local mode or transmit in either full- or half-duplex modes. You can transmit data character-by-character as it is typed, a line at a time with screen editing, or transmit complete disk files. Incoming data is normally displayed as it is received, or you can save it to a disk file. In all modes you can get a printed copy of data sent and received, with both Commodore and ASCII printers supported.

A simple status line is always displayed at the top of the screen to indicate current error conditions, terminal status, operating modes, time of day, file names, etc. An internal timer can be set if you need a reminder to log off a system, go to dinner, or whatever.

A Quick Read feature provides a quick and convenient way to load often-used data and command strings from disk with a minimum of key strokes. A sample file is included on the disk with additional information on STCP.

All communications are in standard ASCII, with STCP providing all necessary data conversions. When transferring disk files to or from your Commodore system, STCP supports four different file translation formats:

- Commodore Basic programs
 - EHS MAE Assembler/Editor files
 - Binary files such as machine-language object code or Word Pro files
 - pure ASCII files such as VisiCalc files
- For greater flexibility you can filter out or translate special characters. A 128-byte table contains an entry for each of the 128 possible ASCII characters. You can use this table to encrypt and decode transmissions.

Currently only 300 baud is implemented, but a 1200 baud enhancement is expected to be provided to purchasers at no cost when developed. The system supports the standard XON/XOFF control codes to prevent buffer overruns. For nonstandard systems the actual control

codes can be modified if required.

You can easily send commands to any disk drive, and not necessarily device 8. Disk commands use the older DOS wedge format, but enclosed in quotes. Thus you can scratch, rename or copy any file at any time.

If necessary you can return to Basic or the machine-language monitor, or you can kill the STCP and reset the system. These and other commands are all selected from a convenient menu so you don't have to remember a whole list of commands. Any further input, like file names and types, is prompted by the system.

I've been using the STCP package heavily for about two weeks with a Signalman modem on my 8032. So far I haven't experienced any problems other than usual phone line noise. The STCP package is well written with good documentation. Once you've played with it for a while you'll find it's easy to use. Having a modem and a good terminal software package like this can really open up a new world of applications for your Commodore system.

The STCP package sells for \$129.95 through Eastern House Software (3239 Linda Drive, Winston-Salem, NC 27106). They have a long list of other products for Commodore systems, including one of the best available assembler/editor packages—MAE. You might just want to drop them a line and get a copy of their latest catalog. CGRS Microtech (PO Box 102, Langhorne, PA 19047) also carries the STCP package, at the same price, but refers to it as Compak. The Portmaker board is available separately from them for \$69.95.

By the way, CGRS Microtech is the company that supplies the PEDISK systems for Commodore computers. The single-drive five-inch system provides an economical system that can be later expanded. The eight-inch system provides IBM 3740 format and can be programmed to exchange data with minis and mainframe computers.

PEDISK II offers the fastest disk system available for Commodore systems. With a transfer rate of 250K/second it

Address correspondence to Robert Baker, 15 Windsor Drive, Atco, NJ 08004.

CRUSH THE KRYON EMPIRE IN ENLIST MEGAWARS



MegaWars, a real-time space battle between the forces of the Colonists and the Kryon Empire. Join an intergalactic shootout with up to eight starship commanders transmitting orders from the keyboard cockpits of their craft anywhere in the U.S.A.

THE ULTIMATE COMPUTER CONFLICT

Attacking, evading, scanning, communicating. That's MegaWars. Easy to learn but difficult to master. That's why CompuServe will give one free hour to every MegaWars player entering a game before December 31, 1982.

Call toll free
800-848-8990.

You'll receive the illustrated guide to CompuServe, America's most comprehensive Videotex service, plus the MegaWars Commanders Briefing.

CompuServe

5000 Arlington Centre Blvd.
Columbus, Ohio 43220
800-848-8990

typically runs three to four times faster than IEEE bus type drives like those from Commodore. However, you lose compatibility with other Commodore systems and have a new disk operating system to deal with.

Other products from Microtech include the Spacemaker and Romdriver ROM switches at \$39.95 and a color video generator board at \$139.95. They also offer various software packages and hardware for other systems.

Hex Dump

Many new VIC owners are starting to experiment with data files on tape, or even on disk now that the VIC-1540 disk is available. The best way to learn how to use data files is to write some short test programs and try various combinations, then take a look at the actual data you've written. Sounds easy, but how do you look at a data file to see what it really looks like?

Well, here's a simple utility that will read any data file on tape and display the hexadecimal value of every byte written into the file. (See program listing.) For added convenience it also displays any displayable characters and the relative hex location of each byte from the beginning of the file.

The display contains the four-charac-

ter location in hex, the hex value of each byte, then the corresponding displayable characters for that line. The program is currently set for four bytes per line for the limited VIC-20 display, but could easily be modified for 40- or 80-column displays by changing the value of L in line 240 for eight or 16 bytes per line.

Looking at the program listing, line 250 opens the first (or next) data file on tape for reading. This line could easily be changed to an appropriate Open command for disk files. Line 280 reads a single byte from the file using the Get# command. This avoids problems associated with Input# and lets you see every character of the file.

Lines 300 to 330 print the hex value of the byte and add displayable characters to a string printed at the end of each line. Lines 340 to 360 increment the byte counter and start a new line when the proper step is reached. Lines 370 to 410 allow stopping and starting the display as desired, while lines 430 to 450 provide decimal-to-hex conversions for the display.

Now you can easily look at the data you create and investigate the exact format of the data file.

Misc

Compute Books has another new book titled *Programming the PET/CBM*, writ-

ten by Raeto Collin West. This is dubbed "the reference encyclopedia for Commodore PET and CBM users," and rightfully so! It contains more detailed information on the Commodore systems than I have ever seen before in one place, and is probably the most accurate reference available.

It seems aimed at the serious user, with quite a bit of hexadecimal notation and references to machine language. It covers only the 2000, 3000, 4000 and 8000 series machines, but covers them in great detail.

Sections of the book cover Basic syntax and how it works, program and system design, peripherals, graphics and sound, machine code, ROM routines and RAM storage, and various types of programs. The sections on Basic commands provide complete descriptions, valid syntax, examples, special notes, abbreviations, internal system operation and ROM entry points. If you're a serious Commodore user, it's definitely worth the \$24.95.

Computant, Inc. (34 Lamplighter Drive, Manchester, CT 06040), recently announced their Computant Patient Accounts Management System for dental offices. It runs on the Commodore 8032 with an 8050 disk and a printer. This is a computerized filing, accounting and billing system designed for use in the small to moderate sized dental practice. It stores the records of up to 3500 patients, including the records of family groups. An expanded version is available for a larger number of patients. Price is \$10,500.

Willie Kusche, of Wilserv Industries (PO Box 456, Bellmawr, NJ 08031), recently pointed out a small problem with the CBM 2031 single disk drive when it is used with CBM 3.0 Basic. Apparently the drive can function erratically, responding to a non-load read command when used with this older version of Basic. Willie has found a fix but it involves a patch to the SF000 ROM of the 3.0 Basic ROM set:

```
SF17F: 4C ED FF EA
SFFED: AD 40 E8 29 FB 8D 40 E8
SFFF5: A9 5F 4C 87 F1
```

This patch apparently fixes the erratic reading problems. Willie is offering to supply a replacement ROM with the above patch for \$15 to anyone who cannot program his own. By the way, Willie is the author of KMMM Pascal carried by AB Computers of Colmar, PA.

As of September, the *Midnight Gazette* and *The Paper* have combined into one bimonthly publication. At the time of this writing the new publication did not have an official name, but it should be decided soon. It will be available only on a subscription basis, costing \$20 for six issues. A subscription card can be found in the *Midnight Compendium* currently on sale, or you can send requests to Jim Oldfield, 635 Maple, Mt. Zion, IL 62549. □

```
100 REM *****
110 REM *
120 REM * TAPE DATA FILE
130 REM * HEX DUMP UTILITY
140 REM *
150 REM * BY: ROBERT BAKER
160 REM *
170 REM *****
180 :
190 PRINT"␣  TAPE HEX DUMP": PRINT: PRINT
200 PRINT"HIT ANY KEY TO HOLD"
205 PRINT"OR CONTINUE DISPLAY": PRINT
210 PRINT"HIT 'Q' TO QUIT"
220 PRINT" (AT ANY TIME)"
230 PRINT: PRINT: PRINT"-----"
240 L=4: H$="0123456789ABCDEF"
250 OPEN 1
260 PRINT"TAPE HEX DUMP": PRINT
270 B=0: GOTO 360
280 GET#1,C#
290 IF ST <>0 THEN PRINT: PRINT"ST =";ST: GOTO 420
300 V=0: IF C#<>" " THEN V=ASC(C#)
310 GOSUB 440: PRINT" ";
320 V=V AND 127: IF V<32 OR V>95 THEN S$=S#+".": GOTO 340
330 S$=S#+C#
340 B=B+1: IF INT(B/L) <> B/L THEN 370
350 PRINT S$: S$=""
360 GOSUB 430: PRINT": ";
370 GET C#: IF C#="" THEN 280
380 IF C#="D" THEN 420
390 GET C#: IF C#="" THEN 390
400 IF C#="D" THEN 420
410 GOTO 280
420 CLOSE 1: PRINT: PRINT: END
430 V=INT(B/256): GOSUB 440: V=B-(256*V)
440 V1=INT(V/16): PRINT MID$(H$,V1+1,1);
450 PRINT MID$(H$,V-(16*V1)+1,1);: RETURN
```

Program listing. VIC utility that reads and displays data files.

SONICS DELIVERS:

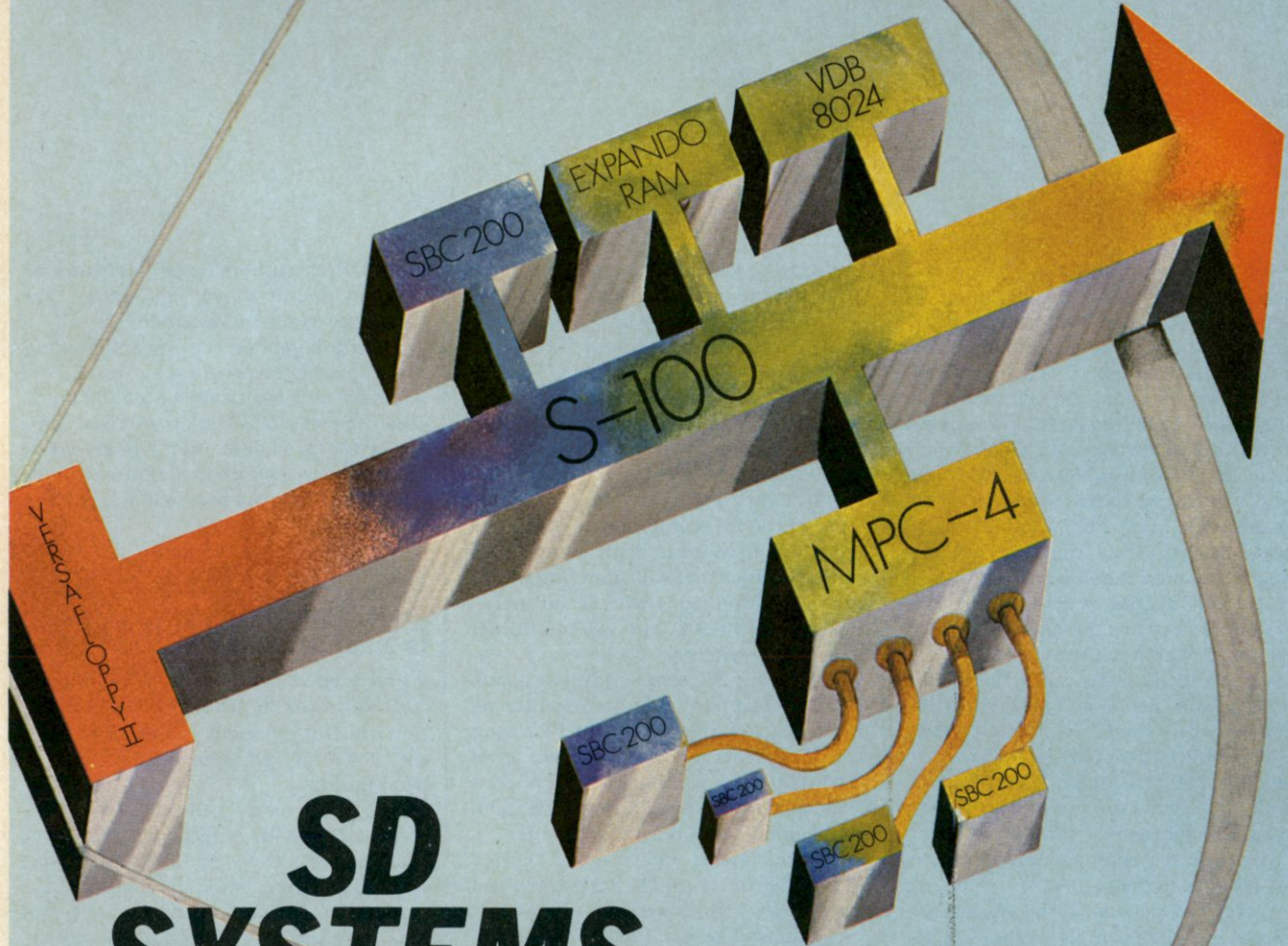

SD SYSTEMS.

SONICS MICRO SYSTEMS' PLEDGE TO THE CUSTOMER IS :

1. PROFESSIONAL TREATMENT
2. FULL TECHNICAL SUPPORT
3. ON-TIME DELIVERIES
4. COMPETATIVE PRICES

ORDER ENTRY, STATUS AND DELIVERY.

THAT'S OUR JOB!

TECHNICAL PROBLEM SOLVING.

THAT'S OUR JOB!

DELIVERY ON TIME, ON PRICE.

THAT'S OUR JOB!

THE BEST FOR LESS.

THAT'S OUR JOB!

CAN YOU AFFORD NOT TO TRY OUR APPROACH?

BOARD LEVEL PRODUCTS

SBC 200	\$308
EXPANDORAM II	\$417
EXPANDORAM III	\$799
VERSA FLOPPY II	\$355
VDB 8024	\$465
MPC-4	\$495
Z-80 STARTER KIT	\$299
MODEL 200 64K RAM	
SOFTWARE BANK SELECT	\$450



SONICS

MICRO SYSTEMS INC.

1500 N.W. 62ND STREET • SUITE 508

FT. LAUDERDALE, FL 33309 • 1-800-327-5567

In Florida Call 305/776-7177

Cientes Latinoamericanos serán atendidos por nuestro departamento internacional (en español), bajo la gerencia de la LCDA. Joan Voyles.

What's the Truth About PC?

Column Cuts Through Heat And Smoke

Few microcomputer introductions have generated as much smoke and heat, and as little light, as IBM's move into personal computing. Generally, the trade press agrees that the PC is awesome in a number of respects: the hardware, the graphics capabilities and the documentation to name a few. Equally widespread is the feeling that mistakes were made (one user called the keyboard "the biggest disappointment in my life"), that little or no good software exists, and, on the outer fringes of sanity, that a conspiracy exists on the part of IBM reviewers and commentators to praise the entry out of proportion to what it delivers.

Well, the truth of the matter is that it is an awesome machine, that some small mistakes *were* made, and that currently we are in the growth part of the evolutionary life cycle. This means that many potential PC users aren't sure it's the right first choice for them or don't know how to compare their current machine against the added benefits of a PC.

Buyers are faced with the equally significant problems of (1) evaluating the growing avalanche of hardware (single, double or hard disks?), software (which of the word processors do I buy?) and third-party documentation/support (which user's group should I join, and what about that new PC book?), and at the same time, (2) learning the ins-and-outs of their new machine so they can program it to do useful work.

No monthly column can deal with all these issues simultaneously. But my goals in providing a regular space for the PC are to address the concerns I perceive folks struggling with: trying to decide how good the machine is; whether it's worth getting as a first unit (or even putting that Apple or Heath in the closet for); once it's bought, trying to figure out how to make it do something useful; and how to discriminate among all those vendors with their hands out for loose change.

To meet these goals, I'll devote part of each column to general commentary,

and sometimes opinion, about the PC in general and how it stacks up against other machines I know and love (mostly, an Apple II, a Heath/Zenith Z-89 and a TRS-80 Model I). In addition, I'll review available software and hardware for the PC, *always* testing it before writing about it, and tell you honestly what you might want to buy and what you ought to avoid. Third, I'll try to give you some sense of the PC's programming capabilities in each column, with some home-baked routines that will show you what is and isn't compatible from other machines to the PC, and where I think it outdistances them.

Sometimes I'll adapt an already-published program to illustrate what the addition of color and some of the PC's other advanced features, like software interrupts, can do for workaday dull Basic routines. And I'll always be sensitive to announcements of upcoming products, to your input about what you've learned, and to the rumor mill to keep you ahead of the pack. I think we can turn some of that heat and smoke into a little light if we work together.

What I Need from You

There are three classes of folks I need to help me do this job: owners, non-owners and vendors. If you're in class one, you're going to be a "heavy hitter" around here. Send me (short) programs showing your machine's capabilities, what you've learned, reports of bugs, general questions, or whatever. Please send paper mail to my home address. If you want a reply, I won't promise but I'll do my best; a self-addressed stamped envelope is requested. Send electronic mail to Source Mail TCD 292 and EMail on Compuserve, 730, 125.

If you're a non-owner, you can also be of great help. What do you like or not like about the PC? What factors will you use in deciding whether to get a(nother) com-

puter? What rumors have you heard, or announcements have you seen, that you'd like to see investigated?

If you're a vendor, are you announcing a new or adapted program for the PC? Do you have new hardware we should know about? Send a description and/or a sample for me to evaluate. If it's really good, I'll make sure everybody knows about it. If it's bad, I'll do my best to laugh you out of business.

Just How Good Is That Machine?

Pretty good, my friends. What follows is all subjective, and a little bit of a confession too. But I thought you'd rather have the voice of experience than timing benchmarks.

I currently own three micros—an Apple II, a Zenith-89 and the PC. I have access as well to a \$20,000 dedicated word processor, and have significant experience with a TRS-80 Model I. If a gun were put to my head and I was ordered to break up every system but one, I'd save the expensive word processor. Fooled you, didn't I? To a writer there's no substitute for a dedicated word processor. WordStar on the PC is a brilliant program, but it can't beat a machine that only does *one* thing and does it very well. No, the PC isn't as good for production writing as a Xerox 860, though it's pretty close!

OK, the choice has to be among the micros, does it? Well then, hands down, I'd keep the PC. It is a pure joy to program.

Thomas V. Bonoma, 45 Drum Hill Road, Concord, MA 01742, is a professor of marketing and an independent consultant, in addition to an addicted computer hobbyist. A psychologist by training, he is the author of a number of books, articles and monographs on marketing, psychology and management.

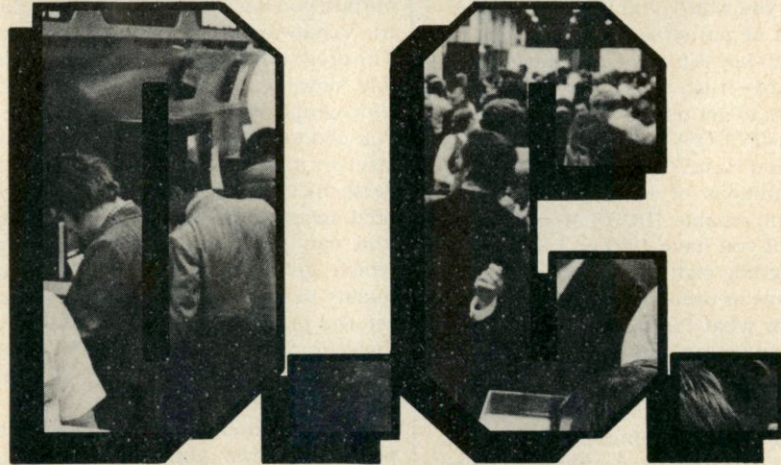

SHOWS FOR YOU IN '82

THE NATIONAL COMPUTER SHOWS are the largest public computer expositions in the country. They feature hardware and software for business, industry, government, education, home, and personal use.

Under one roof you'll be able to test the new computers, desk top computers, data and word processing equipment, and a huge array of computer peripherals, computer services and computer supplies.

At each show you'll see all the major brands, all the major manufacturers, the big distributors and the local dealers and retailers. Everything together and for sale at super show prices.

Don't miss the National Computer Show coming to a city near you. Admission is \$5 per person per day.

TICKET INFORMATION:

Send \$5 (payable to National Computer Shows) for each day-long ticket along with the name of the Show you plan to attend to the address below. Tickets can also be purchased at the show.

The National Computer Shows,
822 Boylston St., Chestnut Hill, MA 02167
Telephone: 617-739-2000

BOSTON

THE NORTHEAST PERSONAL COMPUTER SHOW

Friday-Monday October 8-11 (Columbus Day Weekend)
Hynes Auditorium/Prudential Center
Show Hours: Friday 11 am to 9 pm,
Saturday & Sunday 12 noon to 9 pm,
Monday 11 am to 6 pm

WASHINGTON, D.C.

THE MID-ATLANTIC COMPUTER SHOW

Thursday-Sunday October 28-31
D.C. Armory/Starplex
Show Hours: 11 am to 6 pm daily

BOSTON

THE NORTHEAST BUSINESS COMPUTER SHOW

Thursday-Sunday November 11-14
Hynes Auditorium/Prudential Center
Show Hours: 11 am to 6 pm daily

ATLANTA

THE SOUTHEAST COMPUTER SHOW

Thursday-Sunday December 9-12
Atlanta Civic Center
Show Hours: 11 am to 6 pm daily

THE NATIONAL COMPUTER SHOWS

822 Boylston St., Chestnut Hill, MA 02167

Z-80 SINGLE BOARD COMPUTER \$49.95

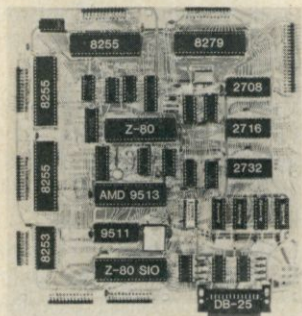

The MASTER CONTROLLER BOARD contains:

- Z-80 Microprocessor: will run 8080/8085 and Z-80 programs.
- 72-Parallel I/O lines; three 8255s
- Keyboard controller: 8279
- 12K- EPROM: three sockets for 2708, 2716, 2732
- 2K-RAM: 2114s
- 8-Sixteen bit counter timer channels: one 8253 and one AMD 9513
- 2-Serial I/O ports; one Z-80 SIO chip. One port has an RS-232 interface and connector.
- 1-High speed arithmetic processor: AMD 9511

All the I/O chips are memory mapped AND I/O mapped. A bus expansion connector is provided. Can be operated on 5 volts only.

All this on one board less than nine inches on a side

Only three LSI chips (Z-80, 8255, and EPROM) plus support gates and buffers are required for a working controller.

BARE BOARD \$49.95
With documentation.

MINIMUM KIT. Includes bare board with documentation, one each Z-80, 8255, 2716, four 2114's, 4Mhz crystal, and support gates and buffers, all socketed. \$119.95

MONITOR PROGRAM allows a CRT or TTY to control the MASTER CONTROLLER. This program requires the minimum kit and the serial parts kit. A programmed 2716 and listing is supplied with the monitor. \$29.95. Listing Only \$19.95

SERIAL PARTS. Includes 8253, Z-80 SIO, 1488, 1489, sockets, and DB-25 connector \$49.95

POWER SUPPLY. 5V2A, -5V $\frac{1}{4}$ A, +12V $\frac{1}{4}$ A, -12V $\frac{1}{4}$ A. \$44.95

ASSEMBLED and TESTED fully populated with monitor program less 9511. \$399.00

USA & CANADA include \$3.50 postage and handling. We ship World Wide please include 15% for shipping.

R.W. ELECTRONICS
3165 North Clybourn—M
Chicago, IL 60618
(312) 248-2480

It's hard to describe for first-time buyers or novices, but microcomputers can be easy or hard to live with. Much depends on what the designers and software engineers put in them at birth.

The Apple, for example, a machine for which I have much respect, is distinctly unfriendly. I've never had to learn so many calls, peeks, and pokes in my life. The Zenith, one of the best data/word processing machines on the market bar none, is so graphics primitive it's laughable (they've fixed this in the newest introductions). Nope, for my money, the PC is ideal for either the first-timer or (especially) the experienced user—it *likes* to be programmed, *likes* to use graphics along with text (no peeks or pokes here, unless you want), and *likes* to be used.

Don't be put off by those who tell you the enter key is in the wrong place on the keyboard—it isn't, it just takes a couple of hours to get used to it. The operating system (PCDOS) and both regular disk Basic and BasicA are truly excellent implementations of code; they're usable, clear and reliable. (DOS 1.10 is what you want—if you have 1.00 or 1.05, *pay* for the upgrade right away.) Those of you who have or used to have TRS-80 Model I's know what I'm talking about when I say the machine *likes* to be used—you've got one of the best on this score.

In future columns I'll talk about how to configure your machine when you buy it, and what to put on it afterward. We'll start with the basics, like whether you should kill the savings account for a color graphics board and monitor (you should), and whether you need disks more or less than you need color. I'll have some kind and some hard words for the IBM printer (i.e., Epson MX-80FT), and some words about interfacing non-IBM peripherals to the serial port (asynchronous communications adapter). Then, later on, I'll talk about hard disks and such.

Software to Know and Love (?)

This month I'm going to talk about two graphics screen dumps for the IBM Epson printer, and a little-known but very nice PC game.

The graphics screen dumps are Videograph 88 (Windmill Software, 1058 Joan Drive, Burlington, Ontario, Canada L7T 3H2, \$49.95) and the Versaware Graphics Hardcopy System (Versa Computing, Inc., 3541 Old Conejo Road, Suite 104, Newbury Park, CA 91320, \$40). These programs represent two very different graphics dumping approaches. (Note: Both programs require that an optional set of graphics chips, called Grafrax-80, be installed in your Epson. If you don't know whether you have these, you probably don't. If you have an Epson MX-100 or Epson MX-82, you've got them.)

Videograph 88 is a machine-language (.COM) program which is loaded when

you start your machine, and then forgotten until it is needed. It uses the print screen key just like a text dump to let you print out your graphs, computer pornography, or whatever. The program prints one size of figure only, and automatically shades the printed output depending on the screen color and pattern. No options can be chosen by the user. It's a good program because it's simple, it works through a single key once loaded, and it otherwise stays out of your way. It can also be called under program control in Basic.

Versaware's system takes a different approach. The program operates only on saved .PIC files, not on the screen display. And you can't just press a key to get output; you have to save the picture, load the Versaware program, and then run it. The program is slow—indeed, it is incredibly slow, but it gives options that the Videograph system does not. You can, if you choose, decide to make a little (1/4 size) print, or a regular one. You can "reverse ink" the picture—that is, make colored spots black and black ones white. You can print in high-density mode, which gives increased regularity and quality to your picture. And you can offset the printed image (in tenths of an inch) from the left margin of the paper. All in all, a useful set of options which Videograph doesn't allow.

So which should you buy? Well, it depends on what you do. If, like me, you're not much of an artist but use a lot of bar charts that need to be dumped real time from the screen to paper, then the Videograph 88 is the right system for you. But if you can use color reversal, offset and size reduction options, and you can live with using BSave to move a .PIC file to disk and then printing it later, Versawriter's system is very flexible. Unlike other packages I've looked at, both these packages appear to offer value for the money.

Another package I'll tell you about this month is Computer Crossword (Dolphin Software Corp., 318 Country Club Road, Newton, MA 02159, about \$40). It's a well-done package that lets you generate complete (up to 25x23 on a monochrome, or 21x20 on a color monitor) crossword puzzles (with clues), solve puzzles already created, and in general have fun. The program (on disk) comes with good documentation and over ten sample puzzles. The program makes limited but welcome use of the PC's color capabilities. It features an interesting mode that veteran crossword puzzlers would pay gold for: While solving a puzzle, select an option and the machine erases any wrong letters you've typed in, leaving all the correct ones alone. Good Lord, computerized cheating! This program would be a very good value at \$20, give fair value for the money at \$30, and is overpriced at \$40. However, it is a nice program, and I don't hesitate to recommend it to you.

New Hardware/Software

I'm sitting on a pile of press releases at least 1½-inches thick of new goodies for the PC. I'll get review copies of what looks worthwhile, check them out and have lots more to say about "what's new" in future columns. Here, let me tell you about three new packages you may want to be aware of.

The Answer for the IBM PC is an electronic card file program to end all filing programs, it would appear from the demonstration disk. The program, written in Forth for the PC, lets you design a wide variety (customer information, classroom data, etc.) of input forms, fill them out and then cross-index the living daylight out of them for future retrieval. North American Business Systems, Inc., the manufacturer, is offering a free VIP Kit with a demo disk and (scanty) promotional material to all IBM PC owners through participating retailers. (Call 1-800-325-1485 for the nearest participating retailer.) Though the program looks very good on the demo disk, it is hard to judge without the documentation, retail price and the ability to actually get in there and muck around with the program. So, you may want to check this one out, but I'll have a fuller evaluation in a couple of columns if you're willing to wait.

IBM's recent release of UCSD Pascal for the PC should have hit your Product Center, independent retailer or Sears by now. If you're a Pascal lover, you'll like this implementation. Five volumes of documentation, six (you'll weep all the way through the backup process) disks, two different compilers, and a good set of utility routines and a disk of extras are included with the system in the now traditional, good IBM bindings. I've only bulled through two of the manuals so far, so I'm no expert, but I'm impressed. The system is configurable for variable amounts of add-in memory (though the manual only says how to implement for 64K. Come on, IBM, how about the memory hogs out here?). Two serial communications ports are supported and addressable from "REMIN:" and "REMOU:" logical devices, though with some jockeying. The special IBMSTUFF unit, which customizes the p-System to the PC, looks like a well-done one as well, with provisions for fairly extensive graphics manipulations. I'll have more on this system after I play with it a while. Price is about \$625 at your local retailer.

Finally, another high-priced (\$695) piece of software for the PC that I'm getting familiar with. Context Management System's MBA is a combination spreadsheet, database, word processor and graphics processor for the PC. It requires a heavily-equipped machine with 256K memory, two disks and a color graphics board. However, I think it's a great piece of work, and with some revising will set

the pattern for future working software. You can enter a normal VisiCalc-type spreadsheet under your clients' names, convert it to a database, extract information for use in a letter to them, and graph (pretty sophisticated graphics, too) the same information without ever leaving your chair or your program. When telecommunications capability (which will be offered free to all buyers in the fall) is added, and some of the slowness of the Pascal spreadsheet implementation is eliminated with better coding, I think this package is going to be hard to beat. You should see a demo of it at participating dealers if you can.

A fellow who's got the right idea about software is A. Fleugelman (Freeware, PO Box 862, Tiburon, CA 94920), who has written a great communications program for the PC called PCTALK. Send him an initialized (single-sided) disk and a self-addressed, stamped envelope, and he'll send it to you free. If you like it, he asks for a contribution of \$25 to his Freeware experiment. Great idea, outstanding program—worth twice or three times the asked-for donation.

Finally, on the community/help front, the *Personal Computer Journal* (W. 2317 Garland, Spokane, WA 99205) is a disk-based monthly PC magazine promising working programs, etc. At 85 bucks for a subscription, better let me check it out before you plunk down your money. And The IBM User Group of Toronto (PO Box 1376, Station B, Downsview, Ontario, Canada M3H 5V6) offers a newsletter if you tell them how your system is set up and give them your name, address, telephone, etc., plus \$1. For that price, you can try it yourself!

Promises, Promises

Well, I hate to start off a venture by breaking promises, but I've already gone over the space they promised me, and I don't want the *Microcomputing* editors to get the idea I'm crooked as well as verbose. So, my friends, my great programming tutorial subsection, a little program called PCSCRAZL, will have to wait 'til next month. Honest. I promise. □

MICRO QUIZ

(from page 7)

Answer: 10

For a general N:

$$I=0 \Rightarrow 1<=J<=N=>N \text{ vals}$$

$$I=1 \Rightarrow 2<=J<=N=>N-1 \text{ vals}$$

$$I=2 \Rightarrow 3<=J<=N=>N-2 \text{ vals}$$

$$I=N-2=>N-1<=J<=N=>2 \text{ vals}$$

$$I=N-1=> N<=J<=N=>1 \text{ val}$$

$$1+2+\dots+N=(N)(N+1)/2$$

Circle 74 on Reader Service card.

EPROM PROGRAMMER \$99.95

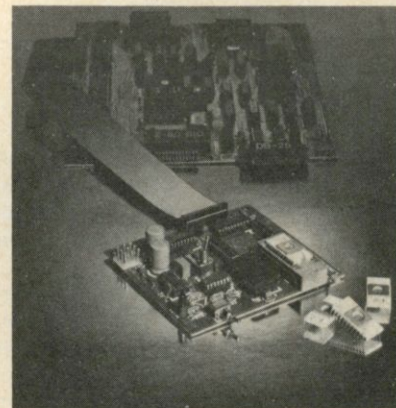

PROGRAMS: 2708, 2716, 2732, 2764, and BEYOND

DUAL programming voltage switch

PROGRAMMING in progress LED

PROGRAM voltage safety switch

COMPLETE software listing for use with MASTER CONTROLLER BOARD type interface

PROGRAMS and verifies, single and multibyte

EPROM can be examined and transferred to RAM

"TEXTTOOL" socket

CAN be used in any system with two output ports

COMPLETE KIT with Texttool socket and software listing for **\$99.95**

2Kx8 6116 RAM or eq. **\$14.95**

26PIN ribbon cable 3 ft **\$9.95**

Extra Identity Modules **\$4.95**

EPROM PROGRAMMER KIT plus MASTER CONTROLLER KIT with Monitor program and Serial parts including 26 pin cable **\$309.95**

Power Supply, 5V2A, -5V¼A, +12V¼A, -12V¼A, 18VAC, **\$44.94**

USA & CANADA include \$3.50 postage and handling. We ship World Wide please include 15% for shipping.

R.W. ELECTRONICS

3165 North Clybourn—M

Chicago, IL 60618

(312) 248-2480

LETTERS TO THE EDITOR

Guns, Butter or Travellers Checks?

Your July cover, picturing the Afghanistans guerrillas clustered about an Osborne 1, explains a letter I received recently. It was dot-matrix printed on aluminum coated paper. (See Fig. 1.)

Of course, your article ("Osborne—Behind Guerrilla Lines," by David Kline, July 1982, p. 43) alleged that the Os-

borne belonged to the journalist, not the guerrillas, but do you seriously believe that with all those guns staring him in the face, he would pick that time to take a firm stand against hardware piracy?

I applaud yet another innovative application for the Osborne 1, with WordStar and MailMerge. (But does it play Yak-Man?)

Walt Bilofsky
The Software Toolworks
Sherman Oaks, CA 91423

The Software Toolworks
14478 Glorietta Drive
Sherman Oaks, CA 91423

Dear Mr. Toolworks:

The freedom fighters of Afghanistan appeal to you, Mr. Toolworks, on this, your Independence Day, to support our fight against those who would extinguish the light of democracy in our poor country.

Your contribution, in guns, butter, or travellers checks, is urgently needed to help us continue our struggle. Your neighbors in Sherman Oaks will admire the engraved certificate you will receive by return mail, naming you and Mrs. Toolworks as Honorary Freedom Fighters.

Please mail the enclosed pledge card today, Mr. Toolworks.

Sincerely,

Muhammad P. Llama^Z

Fig. 1. A letter from Khyber Pass.

Khyber Pass
4 July 1982

Prime Number Nonsense

There's no fanatic like a computer fanatic! Once he's made up his mind, nothing will change it, and he'll do anything to convince you that he's right—including destroying his credibility. What brings on this diatribe is the letter from Dan Farnsworth in the March issue about the 6809 processor (p. 170).

It is true that the 6809 is a faster and easier to use chip than the Z-80 or 6502. It could even be argued that the older 6800 was faster than either of these machines, although that statement would cause long and angry debates.

In any case, comparing a well optimized program, written in assembly language, run on a full-speed machine to a poorly written program, written in Basic, and run on a half-speed machine doesn't tell us much about the relative capabilities of either computer. Or, to put it another way, it's no surprise that an assembly-language program on a 2 MHz 6809 will run 10,000 times faster than a

Basic program on a TRS-80. I own, use and like my SWTP 69/A, a 6809-based machine, but really now, let's at least try to pretend to be fair in our comparisons.

I wrote a 6809 prime number program that finds all of the primes from 1 to 10,000 in .26 seconds on a 2 MHz 6809. I have heard of some 6809 programs that will do this in half the time, but I have not seen them run. I have no doubts that another programmer, more clever or knowledgeable than I, could write a faster prime number program, for almost any machine. However, my point is to emphasize the danger of claiming that a particular program is the fastest that will be, or can be, written.

It is true that *one* of the bottom lines in computers is how fast the job gets done, but how *fast* a job gets done and how *well* a job gets done are not the same thing. But in any case, will a prime number program tell you how fast a particular computer will run?

Yes—if you plan on running prime number programs with your computer.

But honestly, once you have found all of the prime numbers between 1 and 10,000, what do you do with them? Do they change for reruns of the program? In reality, the prime number programs will give you an idea of the processor's speed, but very few real world programs are limited by the processor. Most programs are limited by I/O speeds, or how fast the machine can print, read or write a disk record, or how long we have to wait for a human being to type in a new set of information. The Z-80 based machine we have at work will cheerfully drive a 600 line per minute printer (in some applications), and the Winchester hard disk means that I hardly ever have to wait for a disk transfer to complete. My 6809 at home is limited by my 80 character per second printer, and my dual 5¼-inch floppies. So, despite the very real superiority of the 6809 over the Z-80, I can do a lot more work on the Z-80 at work. Or, due to the implementation of these two systems, the Z-80 is, in effect, the more powerful machine.

But power is only one measure of a computer's usefulness. Ease of use, flexibility, and the availability of appropriate software tools for the job at hand are far more important than raw speed on a benchmark that is unrelated to the work you intend to do. Similarly, the availability of excellent business software doesn't mean much if you want to use the computer as a dedicated device controller.

In the last evaluation, computers come in two speed ranges: fast enough and not fast enough to get the required job done in the amount of time available to do it. However, benchmarks like this prime number nonsense will do little to help anyone decide whether or not a given computer will, or will not, meet this simple and yet unyielding benchmark.

Mike Avery
Austin, TX

Sin of Assumption

In my letter (Letters to the Editor, June 1982, p. 24) I was guilty of the sin of assumption. I assumed that the routine (MVIC,54H CALL E53C) changed the Osborne serial baud rate to 9600, because it did communicate with my other computer at a rate much faster than 1200. Several people have called me saying that the routine does not work, so I checked it further. I found that the rate set by this is 19,200 and not 9600, which does not appear to be available without addition of extra hardware. I might add that this

A feast of computing ideas.



You'll love every byte.

If you work with a 6502 or 6809 based system, you're probably hungry for the facts and ideas that will help you understand the inner workings of your computer. You want to go beyond canned software—use your computer for more than games—learn the advanced programming techniques that enable you to get the most out of your 6502/6809 system.

MICRO, The 6502/6809 Journal, gives you page after page, month after month, of solid information to sink your teeth into. **MICRO** is the premier how-to magazine for serious users of the Apple, PET/CBM, OSI, Atari, AIM, SYM, KIM, and all 6809 based systems including the TRS-80 Color Computer. It's a resource journal internationally respected by professionals in business, industry, and education.

SUBSCRIPTION RATES (U.S. dollars)
 Yearly subscription (ISSN 027-9002) saves 20% off the single-issue price.
 U.S., \$24 (SPECIAL OFFER: Save 30% off single-issue price: 2 years, \$42)
 Other countries, \$27 (via surface mail).
 Foreign air rates available on request.)

Get more out of your Apple . . .

with the **MICRO ON THE APPLE** series

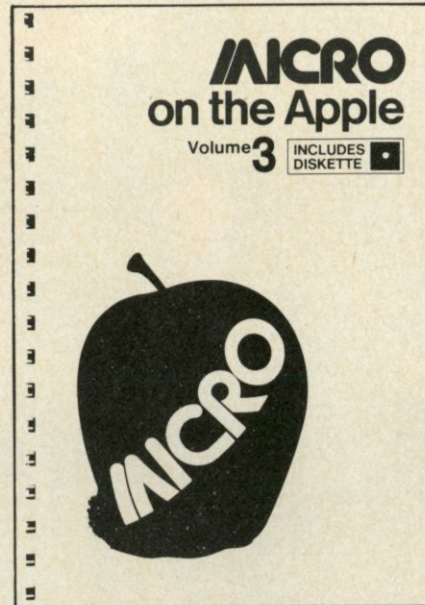

VOLUME 3 just released!

More than 40 new programs on diskette to help you get more from your Apple:

- Machine Language Aids
- I/O Enhancements
- Applesoft Aids
- Graphics and Games
- Reference Information

19 choice articles
43 tested programs on diskette
 (16 sector DOS 3.3 format)

Volume 1 & 2 also available at \$24.95.
 Together **MICRO on the Apple 1, 2, & 3** provide more than 110 programs on diskette for less than \$1.00 each. No need to type in hundreds of lines of code.

with the most important book ever published for the Apple

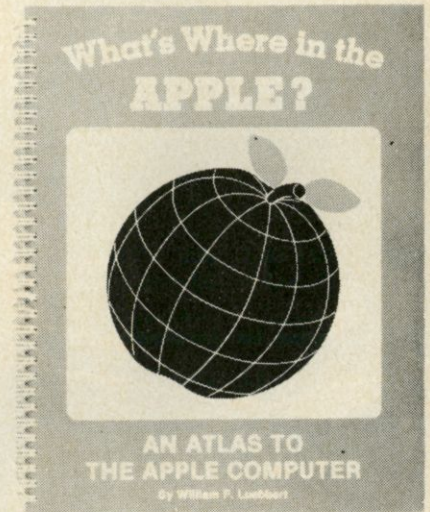

The most comprehensive description of Apple II firmware and hardware ever published—all in one place.

What's Where in the Apple?

• Guides you—with a numerical Atlas and an alphabetical Gazetteer—to over **2,000** memory locations of **PEEKs**, **POKEs** and **CALLs**.

• Gives names and locations of various **Monitor**, **DOS**, **Integer BASIC**, and **Applesoft** routines—and tells you what they're used for.

• Helps BASIC users to speed up their programs.

• Enables assembly language programmers to simplify coding and interfacing.

All Apple users will find this book helpful in understanding their machine, and essential for mastering it!

- ★ Look for all these **MICRO INK** publications at your local computer store, or
- ★ Call our **toll-free** number: **1-800-345-8112**
 (In Pennsylvania, 1-800-662-2444) and charge it to your VISA or MasterCard, or
- ★ Use the order form below. Send your check (payable to MICRO) and the form to: MICRO, Dept. OA, P.O. Box 6502, Chelmsford, MA 01824.

QTY	ITEM	PRICE EACH	COST	<input type="checkbox"/> Check enclosed	<input type="checkbox"/> Charge my credit card below
_____	MICRO on the Apple 1, 2, & 3 . . .	@ \$24.95	_____	Name _____	
_____	What's Where in the Apple? . . .	@ \$14.95	_____	Company _____	
_____	MICRO (U.S.) 1 yr @ \$24; 2 yrs @ \$42		_____	Street _____	
_____	MICRO (Foreign) 1 yr @ \$27		_____	City _____	State _____ ZIP _____
	Subtotal	_____		Signature _____	<input type="checkbox"/> VISA <input type="checkbox"/> MasterCard
	Massachusetts residents add 5% sales tax	_____		Card Number _____	Expiration Date _____
	Add \$2 per book for shipping	_____			
	MICRO Journal excluded. Allow 4-6 weeks for delivery.				
	TOTAL	_____			



Business Is Our Business

Gene Cayot, Sales Manager, MSI. . .

We have been building commercial quality computer systems for 11 years now. . . a lot longer than most companies in our industry. Our reputation for quality and reliability has been firmly established in over twenty different countries where MSI Business Systems are sold.

Let me tell you more about MSI and our business systems. . .

With MSI you get a lot

more than just hardware.

Technical Support

We offer the finest and most extensive customer support of any company in our industry. Our systems are equipped with modems which permit our technical support staff to perform system diagnostics and file maintenance remotely via telephone lines. Our company aircraft allows support personnel to be at the customer's site within a few hours if necessary.

Expandability

Our systems do not have built-in obsolescence. Any MSI computer system can be expanded to run in multi-user mode, with large capacity hard disk drives, and with our business software. MSI systems can grow, as your business grows, to meet your needs.

Customer Training

We hold seminars at selected locations around the country which provide training in all areas of MSI system operations — from installation to the use of our business software.

Business Is Our Business

Our business software modules are designed for "real world" business use. We offer complete audit trail files for all changes to the data base, complete history files, and general ledger posting files. Back-up routines provide maximum protection of the data files on removable disk cartridges.

Let MSI help your business run better

If you have a problem in inventory control, bills of material, order entry/accounts receivable, general ledger, or cost accounting — give me a call personally for more information on an MSI Business System.

MSI **Midwest Scientific Instruments**

220 West Cedar • Olathe, Kansas 66061

913-764-3273

TWX 910 749 6403 • TELEX 437049

time I checked the baud rate on a borrowed terminal which ran at 19,200. Clipping jumper J1 on the PC board should double the 300/1200 rates to 600/2400. I have not tested this and therefore will not recommend it. I have no plans for testing this as I am now running parallel and am very happy with it.

Richard Goosman
Hamilton Square, NJ

Kudos for Data Systems

Unfortunately, our industry seems to be a seller's market—almost anyone can set up a small business and stay afloat long enough to lure several of us (often more than a few!) into sending money to order a mail-order product. All of us have heard what can happen to that money—it might disappear entirely, or, at best, take weeks or months before the product is received. Service, support and quality seem to be concepts forgotten by too many of the companies we do business with.

Because of this dim record, I almost always buy from a local dealer, whom I can deal with face to face if I have any questions or problems. Recently, though, I departed from this rule of thumb to purchase ribbon cartridge refills for my Epson MX-80 printer. As the company that I ordered from, Data Systems, Box 99, Fern Park, FL 32730, is about as far away from my Washington address as you can get within the U.S., I expected a long wait for crisp, dark listings. Amazingly, I received my order eight days after I mailed it! This company is truly a gem—if only the larger companies would follow their example. Not only are they incredibly fast, but I can buy six refills for the price of one new cartridge here in the Seattle area.

I will surely do business with Data Systems again; and heartily recommend them to anyone else contemplating "rolling their own" Epson ribbon refills. Good luck to you, Data Systems.

Terry Owen Permenter
Seattle, WA

Computers and Yacht Racing

In early 1981 the Race Management Committee of the United States Yacht Racing Union (USYRU) began collecting computer and calculator programs relating primarily for race and regatta scoring. Most of the programs have been contributed through the courtesy of their authors and are available for a modest cost from the USYRU office in Newport.

The cooperation of the computer and yachting press was greatly responsible for the success of the program to date. Additional programs are desired, espe-

```

10 *****SHELL SORT*****
20 DIM A(500)
25 CLS:LPRINT "SHELL SORT":LPRINT
40 INPUT "HOW MANY NUMBERS (2-500)";NN:LPRINT "NN = ";NN
50 IF NN < 2 OR NN > 500 THEN END
60 FOR I=1 TO NN
70 A(I)=RND(1)*NN
80 NEXT
85 LPRINT "START TIMING ";TIME#
90 D=NN:FLAG=0
100 D=INT((D+1)/2)
110 FOR N=1 TO NN-D
120 IF A(N)<=A(N+D) GOTO 150
130 T=A(N):A(N)=A(N+D):A(N+D)=T
140 FLAG=1
150 NEXT
160 IF FLAG=1 THEN FLAG=0:GOTO 110
170 IF D>1 THEN 100
180 LPRINT "STOP TIMING ";TIME#
190 GOTO 40

```

SHELL SORT

```

NN = 200
START TIMING 19:41:55
STOP TIMING 19:42:55
NN = 200
START TIMING 19:43:23
STOP TIMING 19:44:26
NN = 200
START TIMING 19:44:33
STOP TIMING 19:45:32
NN = 200
START TIMING 19:45:40
STOP TIMING 19:46:41
NN = 200
START TIMING 19:46:48
STOP TIMING 19:47:48

```

```

NN = 300
START TIMING 19:48:08
STOP TIMING 19:49:57
NN = 300
START TIMING 19:50:06
STOP TIMING 19:51:45
NN = 300
START TIMING 19:51:56
STOP TIMING 19:53:34
NN = 300
START TIMING 19:53:47
STOP TIMING 19:55:19
NN = 300
START TIMING 19:55:28
STOP TIMING 19:56:59

```

SHELL SORT

```

NN = 500
START TIMING 19:58:06
STOP TIMING 20:02:39
NN = 500
START TIMING 20:02:57
STOP TIMING 20:07:19
NN = 500
START TIMING 20:07:34
STOP TIMING 20:11:28
NN = 500
START TIMING 20:11:38
STOP TIMING 20:15:46
NN = 500
START TIMING 20:16:00
STOP TIMING 20:20:09
NN = 1

```

Listing 1. Shell sort with run times on the IBM PC under Advanced Basic.

cially those devoted to other aspects of sailing such as hull or sail design and measurement.

While USYRU makes available the contributed programs and has a few programs for sale, we'd like to include in the catalog sources of other programs of any nature relating to sailing. Information about other programs should be sent to USYRU, Box 209, Newport, RI 02840.

Evans M. Harrell
Chairman,
Race Management Committee
USYRU
Newport, RI

Still More on Speed

With reference to the letter from Mike Smith concerning the Shell Sort (Letters to the Editor, April 1982, p. 26), here is a program incorporating his algorithm to-

gether with some run times on the IBM Personal Computer under Advanced Basic. (See Listing 1.)

Although only five runs of each of three sets of numbers were made, it seems to be evident that the IBM PC performs very efficiently.

Harry G. Friedman
Shreveport, LA

Reply:

Mr. Friedman's algorithm is identical to the one I used on our Apple II+. We could therefore conclude that the IBM PC is faster than the Apple for this type of processing.

This is no surprise. Benchmark tests conducted by the Association of Computer Users indicate that the IBM PC is about 20 percent faster than the Apple II+ in their scientific/engineering test (mostly arithmetic processing). But surprisingly (or not surprisingly, if you're an Apple

MASTER ELECTRONICS, INC.

Authorized "TRS-80" Dealers - * F-723

CAN SET YOU UP IN A

TRS-80

STATE-OF-THE-ART-COMPUTER

STARTING AT 15% DISCOUNT!

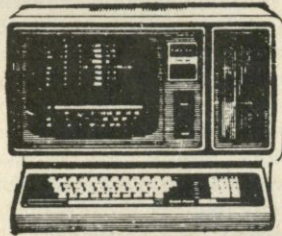

FULLY STOCKED

IN: Model II's

Model III's

ALL- PRINTERS

AND — MORE!!

* PLUS *

THE ALL NEW:

Model 16 and the 8.5 meg. Hard Drive!

CALL US NOW!!!

Toll FREE: 1-800-531-7323

TEXAS CALL COLLECT: 512/689-5536



MASTER ELECTRONICS, INC.
154 NORTH 5th
RAYMONDVILLE, TX 78580



POCKET COMPUTER NEWSLETTER



A NEWSLETTER FOR POCKET COMPUTER USERS

This timely, compact publication provides up to the minute information on pocket computers, including models such as the Radio Shack TRS-80 PC-1 and PC-2, Sharp Electronic's PC-1500 and PC-1211, Casio, Panasonic/Quasar HHCs, and others as they are announced. We only cover PCs capable of executing a high level language such as BASIC.

- Up to the Minute News
- Product & Equipment Reviews
- Important Operating Tips
- Practical Programs
- More By Subscription Only: for a calendar year period (January – December). You get all issues published to date for the calendar year in which you subscribe, at the time you subscribe.

MC/VISA Phone Subscriptions: (203) 888-1946

- 1981/82 Charter Subscriber (Issues 1 – 20). \$40.00 in U.S. (U.S. \$48.00 to Canada. U.S. \$60.00 elsewhere.)
- 1982 Regular Subscriber (Issues 11 – 20). \$30.00 in U.S. (U.S. \$36.00 to Canada. U.S. \$45.00 elsewhere.)
- Sample issue. \$3.00 in U.S. (U.S. \$4.00 elsewhere.) *Due to credit card minimum, this item cannot be charged.

Orders must be accompanied by payment in full. We do not issue invoices for the POCKET COMPUTER NEWSLETTER.

Thank you for your remittance.

Name: _____
 Addr: _____
 City: _____ State: _____ Zip: _____
 MC/VISA #: _____ Expires: _____
 Signature: _____

POCKET COMPUTER NEWSLETTER
35 Old State Road, Oxford, CT 06483

Micro Match solves the IBM PC expansion puzzle.

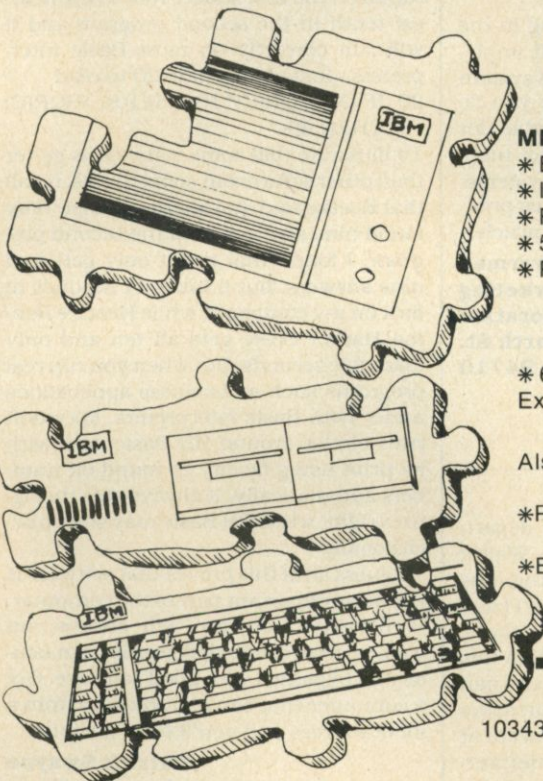

MM64 MEMORY BOARD

- * Expands in 64K increments
- * Includes sockets for all RAM
- * RAM test program included
- * 5 year warranty
- * Parity MM64-1 (64K) \$400.
- MM64-2 (128K) \$510.
- MM64-3 (192K) \$620.
- MM64-4 (256K) \$730.
- * 64K Expansion Kit (9 chips)
- Expands MM64 memory . . . \$108.

Also available:

- * Prototyping Board \$50.
- * Extender Board \$45.

TANDON DISK DRIVES FOR YOUR IBM PC.

- * Installation instructions included
- * IBM PC compatible
- TM100-1 (Single Sided 160K byte storage) \$225.
- TM100-2 (Double Sided 320K byte storage) \$295.

* Send for our free Catalog

To order: Send check or Money Order (US only). Add \$3.50 for Shipping and Handling. California residents add 6% sales tax. Master Card/VISA accepted.

MICRO MATCH Quality Products Personal Computer

10343 Commerce Ave. Dept. M • Tujunga, CA 91042 • (213) 353-5929

Best prices anywhere We beat 'em all!

—COMPUTERS—

ALTOS—List,.....	Less 20%
NorthStar HORIZON HRZ-2-QD...	\$2685
ADVANTAGE.....	\$2985
TeleVideo Computer Systems....	Call
SUPERBRAIN 64K DD.....	1995
64K QD.....	2395
DSS-10 Meg. H D.....	2895
CROMEMCO CS-1.....	3195
CS2.....	3549
CS-3.....	5595
ZH.....	7995
ZENITH Z-90 w/DRIVE.....	2299
Z-89.....	2099

—TERMINALS—

TeleVideo 910C.....	569
912C.....	659
920C.....	719
925.....	719
950.....	915
OKIDATA Microline 80.....	329
Microline 82A.....	469
Microline 83A.....	739
Microline 84.....	Call For Price
C.ITO.....	Call For Price
SOROC IQ 130.....	585
IQ 135.....	719
IQ 140.....	995
HAZELTINE 1420.....	589
1500.....	845
1510.....	1029
ZENITH Z19.....	689

—PRINTERS—

CENTRONICS 739-1 (parallel).....	499
739-3 (RS232C).....	599
704-11 (parallel).....	1569
704-9 (RS232C).....	1519
TI 810 Basic.....	1289
810 Full.....	1549
820 RO Basic.....	1545
NEC 7710 (RS 232).....	2295
3510.....	Call
QUME 9-45 Full Option.....	2125
9-45 Limited.....	2099
Diablo 630 RO.....	2049
PRISM 80.....	895
132 w/color.....	1495
Epson MX-80.....	441
MX-80 FT.....	548
MX-100.....	745

—DISK SYSTEMS—

MORROW Discus 2D.....	835
Dual Discus 2D.....	1385
Discus 2 + 2.....	1069
M5 5Meg. Hard Disk.....	1949
M10, 10 Meg. H D.....	2995
M 26, 26 Meg. H D.....	3349
Decision I.....	1339
CORVUS 5 Meg. Hard Disk.....	2555
10 Meg. Hard Disk.....	3955
20 Meg. Hard Disk.....	4755

Prices are for prepaid orders only, and reflect a cash discount. Charge card orders are slightly higher.

Computers Wholesale

Box 91 Brewerton, N.Y. 13029
315-472-3055

Most items in stock for immediate delivery. Factory sealed cartons, w/full factory warranty. NYS residents add appropriate sales tax. Prices do not include shipping. C.O.D. orders require 25% deposit. Prices subject to change without notice.

fan), they found the Apple to be about 50 percent faster than the IBM on their accounts receivable test (heavy on disk I/O). Does this mean that the Apple is faster than the IBM for business applications in general? Someone should run an inventory or A/R program on the IBM PC and then, using the same program, but formatted for the Apple, run the same data on the Apple and report the results.

The difference in arithmetic processing speed is not totally due to the speed of the CPUs or word length. More than likely the difference is in the programming languages. I'm not familiar with IBM's Advanced Basic but I do know that real variables in Applesoft are five bytes long—one byte longer than single precision variables in most languages. This extra eight bits in the mantissa means that each real number has at least nine decimal digits of precision. Could the processing of numbers which are 25 percent longer (in bit length) account for the time difference? If VisiCalc were run on the IBM PC and then on the Apple with the same data, would there be any noticeable differences in speed or accuracy?

Mike Smith
Seward, AK

Unisoft and Unix

Let me compliment you on Phil Hughes' article, "The Operating System of the Future," June 1982, p. 28. It was short, concise and will certainly give the uninitiated a good idea of what to expect from Unix.

There's only one thing missing in the article—a mention of the UniSoft implementation of the Unix operating system on 68000-based systems. While you do mention Xenix (not yet available for 68000-based systems), you do not mention UniSoft (available for 18 systems, among them the CM Technologies product that you do mention in your article).

Bernard Silverman
Director of Marketing
UniSoft Corporation
2405 Fourth St.
Berkeley, CA 94710

The Right Software

In the Computer Blackboard department in your April issue (p. 22), Walter Koetke lists two short Basic programs that he says will work properly on TI and Atari computers but not on some others. While some might get the idea from this that some computers are better than others, all it actually proves is that some software is better than other software at some things. Most of the Basic interpreters available for small computers have what is called a "binary floating point

package" in them for doing math, while some have a "BCD floating point package." The binary method is usually chosen because of speed and efficient memory use, but it introduces small errors sometimes, especially in addition, and so the first of Koetke's programs does not work properly. The second program is also affected by these errors, and by the method used to find square roots and the accuracy of the constants (if any) used in the calculations.

The BCD method of doing math is more accurate, and if you have a Basic that uses it, it will probably run both programs correctly. For example, Processor Technology 5K Basic (can you remember back that far?), which is still available in a CP/M version from the CP/M Users' Group, has a BCD package and will run both programs correctly. Another Basic from CP/MUG, Basic-E, has a binary package but can also run the second program correctly (but not the first one). It takes five seconds (on a 2 MHz Z-80) to do it, while PT 5K Basic takes 28 seconds. There are faster BCD packages than PT's, but the binary method usually wins the speed race.

All is not lost if you only have one Basic available and it has a binary package. For example, you can make the first program run correctly by doing it this way:

```
10 FOR C = 1 TO 100 STEP .1
20 C = INT(C*10+.5)/10
30 PRINT C
40 NEXT C
```

Line 20 rounds off C to the nearest tenth before it is printed. Similarly, you can round off the first square root to the nearest tenth in the second program and it will run correctly on most Basic interpreters. Just change line 20 to read
20 IF INT(SQR(C)*10+.5)/10 < > SQR(C)
THEN 40

To illustrate that some software is better than other software at some things, recall that Koetke said that Microsoft Basic only found nine answers with the second program. I found that it not only gets just nine answers, but it takes 11 seconds to do it on my computer, while Heath's Benton Harbor Basic gets all ten and only takes five seconds. But when you run real programs such as business applications under both Basic interpreters, Microsoft runs circles around BH Basic, and with its print using facility to round off numbers automatically, it always gets the figures right, while BH Basic may slip up occasionally.

I guess all of this proves that software is the most important part of the computer. Well-written software will always run well, and hardware deficiencies can usually be bypassed with good software. Get a computer that can run software from a lot of sources and you'll have a winner.

Patrick Swayne
HUG Software Developer
St. Joseph, MI

SPECIAL SALE!!

MOST ECONOMICAL SOURCE TO BUY FLOPPY DRIVES — FROM ONE OF THE LARGEST DEALERS IN THE WORLD! NOW YOU CAN BUY TANDON, QUME, TEAC, SHUGART, MPI, SIEMENS, REMEX, YANKEE, APPLE, EPSON, DEC, CDC, CIPHER, NEC, TALLY, ALTOS, ATARI, DATAPRODUCTS, IBM AND MORE . . .
. . . AT LOW COST!! IMMEDIATE SHIPPING!!

APPLE DISK-DRIVE for APPLE II **\$289.00**
 100% Compatible (Runs DOS 3.2 and 3.3) **INTRODUCTORY PRICE**
Z80 Card and 80 Column Card Available
5MB Winchester / Controller / Cables / Software **\$1795.00**
10MB Winchester / Controller / Cables / Software **\$1995.00**

ATARI **Computers/Video Games**
 Models 410, 820, 822, 830, 850 available
ATARI SPECIAL
DSDD Drive **\$649.00**
Add on **\$399.00**
 800 Computer **\$659.00**
 400 Computer **\$339.00**
 810 Disk Drive **\$449.00**
 825 Printer **\$629.00**
 VIC20 **\$249.00**

IBM **TANDON TM100-1 SSDD**
 Disc Drive **\$208.00**
TANDON TM100-2 DSDD
 Disk Drive **\$274.00**
CS111-5 Disk Drive, TM100-1 Compatible **\$199.00**
CS211-5 TM100-2 Compatible Drive **\$259.00**
IBM - MEMORIES
 64K **\$189.00** 128K **\$289.00**
 256K **\$499.00** 512K **\$799.00**
5 and 10MB Winchesters available

CABINETS / POWER SUPPLY

Dual 8" Disk Drive, Cabinet with Power Supply **\$249.00**
 Cabinet/Power Supply for Single 8" Drive **\$179.00**
 Dual 5 1/4" Disk Drive, Cabinet with Power Supply **\$99.00**
 Single 5 1/4" Disk Drive, Cabinet with Power Supply **\$69.00**
 2 Single Side Double Density 8" Disk Drives,
 Cabinet / Power Supply **\$895.00**

PRINTERS / TERMINALS

OKIDATA
 82A **\$459.00** 83A **\$730.00**
 84AP **\$989.00** 84AS **\$1049.00**
EPSON MX-80 **\$469.00**
 MX-80 FT **\$569.00** MX-100 **\$769.00**
BROTHER HR1 **\$799.00**
SMITH CORONA TP1 **\$599.00**

*Call for C.ITOH, NEC, TELEVIDEO,
 ADDS TERMINALS PRINTERS.*

ALL FLOPPIES
Repaired Quickly
at LOW COST

DRIVES / COMPUTERS

QUME DT-5 DSDD 5 1/4" Drive **\$285.00**
QUME DT-8 DSDD 8" Drive **\$479.00**
TANDON: TM100-1 **\$208.00**
 TM100-2 **\$274.00**
 TM100-3 **\$274.00**
 TM100-4 **\$399.00**
 TM848-1 SSDD 8" Thin Line **\$459.00**
 TM848-2 DSDD 8" Thin Line **\$549.00**
 TM602-5 Winchester 5MB **\$999.00**
 TM603-10 Winchester 10MB **\$1149.00**
SIEMENS: FDD 100-5 SSDD 5 1/4" **\$189.00**
 FDD 100-8 SSDD 8" **\$349.00**
 FDD 200-8 DSDD 8" **\$449.00**
SHUGART: SA400 **\$215.00**
 SA450 **\$279.00**
 SA800/801 **\$379.00**
 SA850/851 **\$535.00**
TEAC: FD50A **\$199.00**
 FD50B **\$299.00**
 FD50E **\$299.00**
 FD50F **\$399.00**
MITSUBISHI: M2894-63 8" DSDD **\$459.00**
NEC Computer PC 8000 **Call**
XEROX Computer 820 **Call**

FRANCHISE INQUIRIES WELCOMED

PRICES SUBJECT TO CHANGE WITHOUT NOTICE

COMPUShACK

Computers / Video Games
 A SUBSIDIARY OF PDS Inc.
 2630-H Walnut Ave.
 Tustin, CA 92680

• 24 HOUR ORDERING SERVICE •

TOLL-FREE TELEPHONE NUMBERS

Outside California: (800) 854-8428

Inside California: (714) 730-7207 or (408) 973-1444

Telex: 18-3511 Answer Back CSMA

Micro Software Digest

Compiled by Dan Muse

Vigil

(Reviewed in InfoWorld, June 14, 1982)

System Requirements: Commodore VIC 20, any expansion of 3K or more, disk or tape drive

Manufacturer: Abacus Software, PO Box 7211, Grand Rapids, MI 49610

Price: \$35

Comments: Vigil is a "programming hobbyist system for the Commodore VIC computers with expanded memory," the review says.

"It permits the programmer to create and move video block graphics," according to the review.

"As a programming language, it provides shortcut graphic routines that would be difficult or impossible to execute in Basic," the review says.

Vigil is quite effective as a home graphic programming package; however, since you must own a Vigil interpreter for commercial game programming, it is limited in this capacity. Reader Service number 409.

DFX

(Reviewed in Peelings II, April 1982)

System Requirements: Apple II, 48K bytes, DOS 3.3, Applesoft in ROM or language card, a Hayes Micromodem in slot 2 and a disk drive in slot 6

Manufacturer: Arrow Micro Software, 11 Kingsford, Kanata, Ontario K2K1T5, Canada.

Price: \$45

Comments: "This program is well worth the money for anyone who has occasion to transfer files between Apples equipped with the appropriate hardware," says the review.

"The feature that sets DFX apart is its ability to carry on a keyboard 'chat' with the remote user while a file is being transferred," according to the review. There is no noticeable loss of file transfer speed as a result of this.

"The handling of errors is extensive in DFX and exceptionally well done," says the review. This is "the most user-friendly communication package for two Apples." Reader Service number 401.

Hail to the Chief

(Reviewed in School Microware Reviews, Winter 1982)

System Requirements: 48K bytes Apple II, one disk drive, Applesoft; 48K bytes TRS-80, one disk drive, DOS Basic; 32K bytes Atari, cassette; 40K bytes Atari, one disk.

Manufacturer: Creative Computing Software, 38 East Hanover Ave., Morris Plains, NJ 07950

Price: \$24.95 (on disk)

Comments: In Hail to the Chief, the student's objective is to be elected President of the United States. A strategy must be selected and executed by the student. He must decide what position to take on issues (i.e., energy policy, unemployment, women's rights, health and foreign policy), according to the review.

The student must also handle the financial aspects of his campaign, including fund raising and allocations to promotional projects, the review says.

"This is an excellent program. It creates a level of tension and conflict between position and polls which helps to maintain student interest," according to the review.

The program does require a lot of time to complete and could use more graphics, but on the whole, this is a worthwhile program for the high school or college student, the review says. Reader Service number 406.

Graphtrix

(Reviewed in Peelings II, May-June 1982)

System Requirements: Applesoft, 48K, Applesoft ROM, graphics printer, DOS 3.3

Manufacturer: Data Transform, Inc., 906 E. Fifth Ave., Denver, CO 80218

Price: \$65

Comments: Graphtrix not only prints a Hi-Res screen on your printer, but also allows the user to include graphics, footnotes and superscripts in documents created by the Apple Writer text editor or Editrix (Data Transforms' text editor).

"If you already use Apple Writer, then you will very likely find GT a useful addition to your word processing system," the review says. Reader Service number 423.

Nutrichec Version 2.0

(Reviewed in InfoWorld, June 7, 1982)

System Requirements: Apple II Plus, DOS 3.3, 32K bytes RAM, and one disk drive

Manufacturer: WIMS Computer Consulting, 6723 East 66th Place, Tulsa, OK 74171

Price: \$59.95

Comments: "Nutrichec is a versatile software package that quickly organizes your food intake into nutritional categories," says the review.

The program is designed for healthy persons from three to 80 years of age, and is not meant for people with special dietary needs, the review says.

Nutrichec provides the user with his "entire diet-and-physical-activity analysis," including a hard copy of the results "in five to ten minutes," according to the review.

"The manual is clearly written, well indexed, and overall is a useful reference tool," the review says.

Although this program may require some practice, it is for the most part easy to use for the inexperienced computer user. Reader Service number 403.

Amper-Sort/Merge

(Reviewed in Micro, July 1982)

System Requirements: 48K Apple with Applesoft and DOS 3.3 data files

Manufacturer: S & H Software, Box 5, Manvel, ND 58256

Price: \$49.95 (plus \$3 postage and handling)

Comments: Amper-Sort/Merge sorts sequential or random access text files. It can sort and merge up to five user-supplied file names at machine-language speeds, according to the review.

The program is "user-friendly with ample prompts," the review says. The user is able to sort large text files because the program "uses work files for multiple merging operation under program control," according to the review.

The user must be able to understand the file names and formats of the data to be sorted; however, the user needs no programming knowledge, the review says. Reader Service 421.

Now NRI takes you inside the new TRS-80 Model III microcomputer to train you at home as the new breed of computer specialist!

NRI teams up with Radio Shack advanced technology to teach you how to use, program and service state-of-the-art microcomputers...

It's no longer enough to be just a programmer or a technician. With microcomputers moving into the fabric of our lives (over 250,000 of the TRS-80™ alone have been sold), interdisciplinary skills are demanded. And NRI can prepare you with the first course of its kind, covering the complete world of the microcomputer.

Learn At Home in Your Spare Time

With NRI training, the programmer gains practical knowledge of hardware, enabling him to design simpler, more effective programs. And, with advanced programming skills, the technician can test and debug systems quickly and easily.

Only NRI gives you both kinds of training with the convenience of home study. No classroom pressures, no night school, no gasoline wasted. You learn at your convenience, at your own pace. Yet you're always



backed by the NRI staff and your instructor, answering questions and giving you guidance.

You Get Your Own Computer to Learn On and Keep

NRI training is hands-on training with practical experiments and demonstrations. You don't just program your computer, you go inside it... watch how circuits interact... interface with other systems... gain a real insight into its nature.

You also work with an advanced liquid crystal display hand-held multimeter and the NRI Discovery Lab®, performing over 60 separate experiments. Both microcomputer and equipment come as part of your training for you to use and keep.

Computer Assisted Instruction

Your TRS-80 even helps train you. You receive 8 special lesson tapes in BASIC computer language. Using them in your microcomputer, you "talk" to it as you progress. Errors are explained, graphics and animation drive home key points. Within a matter of minutes, you'll be able to write simple programs yourself.



Training includes the TRS-80 Model III microcomputer, professional LCD multimeter, the NRI Discovery Lab, Computer Assisted Instruction programs and hundreds of demonstrations and experiments.

(TRS-80 is a trademark of the Radio Shack division of Tandy Corp.)

Send for Free Catalog... No Salesman Will Call

Get all the details on this exciting course in NRI's free, 100-page catalog. It shows all equipment, lesson outlines, and facts on other electronics courses such as Electronic Design, Industrial Electronics, TV/Audio/Video Servicing... 11 different career opportunities in all. Send today, no salesman will ever bother you. Keep up with the latest technology as you learn on the latest model of the world's most popular computer. If coupon has been used, write to NRI Schools, 3939 Wisconsin Ave., Washington, D.C. 20016.

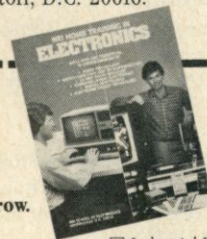

All career courses approved under GI bill.
 Check for details



NRI Schools
McGraw-Hill Continuing Education Center
3939 Wisconsin Avenue
Washington, D.C. 20016

We'll give you tomorrow.

NO SALESMAN WILL CALL.

Please check for one free catalog only.

- Computer Electronics including Microcomputers
- Color TV, Audio, and Video System Servicing
- Electronics Design Technology
- Digital Electronics
- Communications Electronics • FCC Licenses • Mobile CB • Aircraft • Marine

- Industrial Electronics
- Basic Electronics
- Small Engine Servicing
- Appliance Servicing
- Automotive Servicing
- Auto Air Conditioning
- Air Conditioning, Heating, Refrigeration, & Solar Technology
- Building Construction

Name _____ (Please Print) _____ Age _____

Street _____

City/State/Zip _____

Accredited by the Accrediting Commission of the National Home Study Council

172-092

Key Perfect

(Reviewed in Micro, July 1982)

System Requirements: Apple II with 48K RAM, 1 Disk II

Manufacturer: micro-sparc, inc., PO Box 639, Lincoln, MA 01773

Price: \$29.95

Comments: Key Perfect is a "utility which computes 'check codes' associated with Apple II program files," the review says.

Although it seems to work, according to the review, "the program is not particularly user-forgiving." For instance, "the program does not allow a catalog command to be issued while it is running." Reader Service number 420.

Personal Check Manager

(Reviewed in Peelings II, May-June 1982)

System Requirements: Applesoft, 48K Applesoft ROM, one or two drives (printer optional but helpful) DOS 3.3

Manufacturer: Donald Poling, 6929 La Cienega Blvd., Los Angeles, CA 90045.

Price: \$30

Comments: "Personal Check Manager has some major weaknesses," the review says. The documentation is unclear and literally hard to read because of light print; also there is no backup capability for the data disk.

The program does have potential, but the review does not recommend use until corrections are made. Reader Service number 425.

REAP

(Reviewed in InfoWorld, June 14, 1982)

System Requirements: Apple II, DOS 3.3, 48K RAM, one or more disk drives and 80-columns-plus printer

Manufacturer: Datamost, 9748 Cozycroft Ave., Chatworth, CA 91311

Price: \$129.95

Comments: Real Estate Analysis Program (REAP) "attempts to take the work out of providing a comparative analysis of investment potential or real estate properties," the review says.

REAP is "easy to use and can provide you with a ball-park analysis for a variety of real-estate investment situations," according to the review.

The program has adequate error handling and well designed documentation, according to the review.

"The program is well suited for taking a quick and general look at potential real-estate investments." Reader Service number 414.

UFO

(Reviewed in InfoWorld, June 28, 1982)

System Requirements: CP/M 1.4 or greater, one disk drive

Manufacturer: Digital Constructs, 130 Main St., Norristown, PA 19401

Price: \$75

Comments: UFO (User Friendly Operations) is a collection of utilities designed for a wide variety of applications.

"These utilities will definitely be a welcome addition to your software library if you do much file comparison," the review says.

UFO consists of four programs: ADIF, BDIF, CDIF and DEL. "The first three are file-difference detectors. That is, they compare two input files for one or more differences. The fourth program is an enhanced version of the CP/M ERA function," according to the review.

The programs are "easy to use and well documented and they perform as specified," the review says. Reader Service number 416.

Math and Spelling Strategy

(Reviewed in InfoWorld, June 28, 1982)

System Requirements: Apple II Plus or Apple II with Applesoft, DOS 3.3, 48K RAM, one disk drive, color monitor or TV preferred

Manufacturer: Behavioral Engineering (via Special Delivery Software), 230 Mount Hermon Road, Suite 207, Scotts Valley, CA 95066

Price: \$45

Comments: Math Strategy and Spelling Strategy explore the technique of Neuro-Linguistic Programming. The technique is based on the premise that people organize their experiences through "sensory representational systems" (i.e., sight, hearing and so on), the review says.

"Furthermore," according to the review, "people exhibit observable 'accessing cues' when they try to reference one of these systems," the review says.

The "accessing cue" that Math Strategy and Spelling Strategy use is eye movement.

According to the author, people "tend to move their eyes up and to the left when recalling an image," the review says.

Therefore, by moving your eyes appropriately when you learn and recall proper responses, you can improve your ability to visualize correct responses, according to the review.

The programs have good documentation and are soundly designed. Students may have to be guided through by an adult the first time—after that they should do well on their own, the review says. Reader Service number 417.

Master Diagnostics Plus

(Reviewed in Nibble, Vol. 3, No. 1, 1982)

System Requirements: Apple II, DOS 3.3

Manufacturer: Nikrom Technical Products, 25 Prospect St., Leominster, MA 01453

Price: \$75.00

Comments: "An impressive collection of diagnostic routines," according to the review. The documentation is exceptional. "The excellent on-screen prompting provides all the information you need to actually run the tests provided and obtain meaningful results," according to the review. This package should be in the library of every Apple user," the review says. Reader Service number 415.

Electric Duet

(Reviewed in Peelings II, May-June 1982)

System Requirements: Apple II, 48K, DOS 3.3

Manufacturer: Insoft, 10175 S.W. Barbur Blvd, Suite 202B, Portland, OR 97219

Price: \$29.95

Comments: "The Electric Duet is a two voice music synthesizer/interpreter that seems to remain in the tradition of Forte," the review says.

However, it goes beyond Forte in that it can play two notes simultaneously. The ED comes with the option to either play or write music.

"If you think you have the potential to become a computer music programmer, start with this," the review says. Reader Service number 428.

Radar

(Reviewed in InfoWorld, June 21, 1982)

System Requirements: System with CP/M, 64K RAM (optimal), one or more disk drives

Manufacturer: Southern Computer Systems, Inc., PO Box 3373A, Birmingham, AL 35225

Price: \$495

Comments: "Radar (Random Access Data Acquisition and Retrieval) is a program developed to provide quick and accurate data entry and retrieval," according to the review.

"Speed of operation is definitely the strong point of Radar," the review says.

It is assumed that the user is familiar with installing such programs, the review says, so don't count on help from the documentation. However, generally the documentation contains good information. Reader Service number 430.

Circle 25 on Reader Service card.

ELECTRONICS CENTER

5%

SOLUTION* COUPON!

Software Sampling:

The Home Accountant.....\$ 55	DB Master.....\$179
Castle Wolfenstein.....\$ 22	Decision Master.....\$ 22
Personal Filing System.....\$ 69	Easy Writer Pro.....\$165
PFS: Report.....\$ 69	WordStar (Apple II).....\$279
Wizardry.....\$ 39	Spell Star.....\$135
VisiTerm.....\$125	CalcStar.....\$135
VisiDex.....\$215	DataStar.....\$205

*The solution to your cash depletion — This ad is worth an instant 5% off our already low prices of the 146 computer product lines we carry. Just send it in with your order or tell us you saw it in this mag if you call. Coupon void after Sept. 30th.

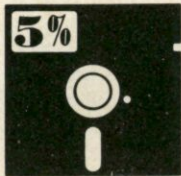

YOUR ELECTRONICS PLAYGROUND

CALL TODAY 1-800-228-4097
In Nebraska 402-476-7331

Or mail order to 1840 "O" St. Lincoln, NE 68508



Circle 54 on Reader Service card.

MONEYGO

for Apple computer with Applesoft and DOS 3.3

The Versatile, Complete PERSONAL BUDGET PROGRAM

with the unique CROSS-REFERENCE FEATURE!

Extract and summarize the info you need to —

- Claim all those tax deductions
- Reconcile your bank statement
- Determine when repairs exceed replacement costs
- Locate proof of expenditure
- Analyze your spending habits — lots more!

MONEYGO has NO RESTRICTIONS on number of categories or length of entry!

THE TOP PROGRAM IN ITS FIELD!

HANDLES CHECK ACCOUNTS, CHARGE CARDS, CASH, BANK TRANSFERS ... all transactions!

flexible to fit your needs ... even subcategorizes income and expenses for each member of your family! Stores over 3000 records per disk ... print-out capabilities ... totals SALES TAX automatically ... flags tax deductible from all categories! And MONEYGO was user tested for two years prior to national marketing!

MONEY GO* floppy disk program & complete documentation

only \$45 (includes shipping)
TN residents add 4 1/2 % sales tax

KEY SOFTWARE
KEY

Apple and Applesoft are registered trademarks of Apple Computer Co.

P.O. Box 3092
Oak Ridge TN 37830

Circle 91 on Reader Service card.

QUALITY SOFTWARE FOR TRS-80 COLOR AND OSI



QUEST — A NEW IDEA IN ADVENTURE GAMES! Different from all the others. Quest is played on a computer generated map of Alesia. Your job is to gather men and supplies by combat, bargaining, exploration of ruins and temples and outright banditry. When your force is strong enough, you attack the Citadel of Moorlock in a life or death battle to the finish. Playable in 2 to 5 hours, this one is different every time.
16K COLOR-80 OR TRS-80 or 12KOSI.
\$14.95.

BASIC THAT ZOOMS!!
AT LAST AN AFFORDABLE COMPILER FOR OSI AND TRS-80 COLOR MACHINES!!! The compiler allows you to write your programs in easy BASIC and then automatically generates a machine code equivalent that runs 50 to 150 times faster.

It does have some limitations. It takes at least 8K of RAM to run the compiler and it does only support a subset of BASIC—about 20 commands including FOR, NEXT, END, GOSUB, GOTO, RETURN, END, PRINT, STOP, USR(X), PEEK, POKE, *, /, +, -, X, X, =, VARIABLE NAMES A-Z, A SUBSCRIPTED VARIABLE, and INTEGER NUMBERS FROM 0 - 64K. TINY COMPILER is written in BASIC. It generates native, relocatable 6502 or 6809 code. It comes with a 20 page manual and can be modified or augmented by the user. \$24.95 on tape or disk for OSI or TRS-80 Color.

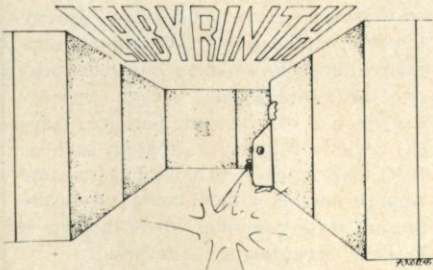

LABYRINTH — 16K EXTENDED COLOR BASIC — With amazing 3D graphics, you fight your way through a maze facing real time monsters. The graphics are real enough to cause claustrophobia. The most realistic game that I have ever seen on either system.
\$14.95. (8K on OSI)



VENTURER!—A fast action all machine code Arcade game that feels like an adventure. Go berserk as you sneak past the DREADED HALL MONSTERS to gather treasure in room after room, killing the NASTIES as you go. Great color, high res graphics, sound and Joystick game for the TRS-80 Color or OSI machines. (black and white and silent on OSI.) Tape only. \$19.95.

AARDVARK - 80

2352 S. Commerce, Walled Lake, MI 48088
(313) 669-3110

TRS 80 COLOR

OSI



GraForth II

(Reviewed in Creative Computing, July 1982)

System Requirements: Apple II, 48K bytes and one disk drive

Manufacturer: INSOFT, 10175 Barbur Blvd., Suite 202B, Portland, OR

Price: \$75

Comments: "If you really want to produce high quality 3-D animation, buy GraForth II," the review says. However, the review says, for 2-D animation "all the languages are equally good."

"If you've been trucking along with Apple Basic or Pascal, you will appreciate the completeness of this new package," according to the review.

"GraForth II does almost everything that a graphics language should do," the review says. Reader Service number 412.

Apple Pilot

(Reviewed in Creative Computing, July 1982)

System Requirements: Apple II Plus, 48K bytes, disk drives (two drives required for authoring)

Manufacturer: Apple Computer, Inc., 10260 Bantley Drive, Cupertino, CA 94017

Price: \$150

Comments: Apple Pilot is designed to allow the person unfamiliar with computational details to "develop useful and sophisticated courseware for use in the classroom," the review says.

"Overall this is a useful program and can be put to good use by both the experienced and inexperienced courseware developer," according to the review. Reader Service number 413.

ASCOM 2.0

(Reviewed in InfoWorld, June 28, 1982)

System Requirements: IBM PC, PC-DOS, one disk drive minimum, Asynch card and modem

Manufacturer: Dynamic Microprocessor Associates, 545 Fifth Ave., New York, NY 10017

Price: \$175

Comments: "The ASCOM (Asynchronous Communications) program is a versatile modem-control program for the IBM Personal Computer. It performs most, if not all, of the tasks required for effective communication," according to review.

For the most part the error handling is good; however, a disk-full error causes you to lose any captured information, the review says.

"ASCOM is impressive in its range of options. You'll need a little familiarization" with the program, but common tasks are quite easy, according to the review. Reader Service number 418.

Metric Drill

(Reviewed in School Microware, Winter 1982)

System Requirements: Apple II, 48K, Applesoft in ROM, one disk drive

Manufacturer: Hartley Courseware, Inc., PO Box 431, Dimondale, MI 48821

Price: \$49.95

Comments: "This program is an effective practice device for use while learning the metric system." The only drawbacks, the review says, are that the teacher may have to help the student select the appropriate lesson and that only two answer choices are provided, so guessing correctly is not too difficult.

One of the advantages is that the teacher can modify the program. Metric drill suggests course/subject and grade levels, the review says.

The program "operates properly and is free of bugs." Reader Service number 419.

If you have occasion
to use VisiCalc as a
planning tool, RVC
is a must.

RVC

(Reviewed in Peelings II, April 1982)

System Requirements: Applesoft, 48K bytes, Disk II, Hayes Micromodem II

Manufacturer: Arrow Micro Software, 11 Kingsford, Kanata, Ontario K2L1T5, Canada.

Price: \$45

Comments: "This is one of the first programs to take a major application program and extend its range by using the modem and telephone," according to the review.

RVC (Reflexive VisiCalc) allows two users of VisiCalc to interact on the same spreadsheet over a telephone line. "This interaction can be used for bargaining, cooperative budget formulation, or a wide variety of other applications," says the review.

"This is a very exciting package," says the review. Without a program such as RVC, there is no way to move data from one Apple to another without being "physically present at the computer where the data is located," according to the review.

"If you have occasion to use VisiCalc as a planning tool with another Apple user, RVC is a must," the review says. Reader Service number 402.

SAT Vocab

(Reviewed in School Microware Reviews, Winter 1982)

System Requirements: PET 8K bytes

Manufacturer: Microphys, 2048 Ford St., Brooklyn, NY 11229.

Price: Ten programs on tape—\$10 each.

Comments: SAT Vocab is an excellent package which prepares students for the Scholastic Aptitude Test, the review says. The flaws are that it is not well structured and graphics are not well used. However, the "prerequisite concepts and vocabulary are quite reasonable" and the program "is free of bugs." Reader Service number 407.

The Home Accountant

(Reviewed in Peelings II, May-June 1982)

System Requirements: Apple II Plus, 48K, one or two disk drives, printer (132 columns optional) DOS 3.3

Manufacturer: Continental Software, 16724 Hawthorne Blvd., Lawndale, CA 90260

Price: \$74.95

Comments: "The program has many capabilities and the power to manipulate and track inputs through the many account categories," according to the review. However, categorizing assets and liabilities into accounts is very time consuming.

The Home Accountant is marketed for the Apple owner who is not necessarily familiar with accounting practices; however, the review says, the documentation does not support the intended user.

The program has many capabilities that are not discussed in the documentation, so it is difficult to effectively use the program. Reader Service number 426.

Circle 172 on Reader Service card.

Verbatim flexible disks

Call Free (800) 235-4137 for prices and information. Dealer inquiries invited. C.O.D. and charge cards accepted.

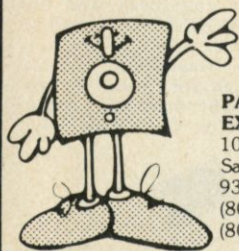

PACIFIC EXCHANGES
100 Foothill Blvd.
San Luis Obispo, CA
93401. In Cal. call
(800) 592-5935 or
(805) 543-1037.

Circle 140 on Reader Service card.

OMNITEK COMPUTERS INTERNATIONAL, INC.
1300 MAIN STREET TEWKSBURY, MASS
617-851-4580

Smith-Corona Daisy Wheel Printer.....	639.00
Verbatim 5.25" D. L.....	25.00
16K RAM KITS.....	13.00
Okidata Microline 80.....	319.00
Okidata Microline 82A.....	434.00
Okidata Microline 83A.....	679.00
Epson MX-80.....	439.00
Epson MX-80 FT.....	544.00
Epson MX-100.....	689.00
Radio Shack Mill w/48K.....	879.00
Radio Shack Mill w/48K and 2 40T dr	
1649.00.....and RS232.....	1739.00
40 track economy drive Power Supply	
with case.....	179.00
Tandon drives with Power Supply and case	
40 track single head.....	249.00
dual head.....	359.00
80 track single head.....	339.00
dual head.....	437.00
5.25" Power Supply and case.....	39.00
8" Power Supply and case.....	99.00
CENTRONICS 739 Printer.....	469.00

Omnitek Computers International Inc.

TRS-80 is a reg. trademark of Tandy Corp.
Prices are for mail order only **TERMS:** Check,
money order, Mastercard and Visa accepted.
F.O.B. Tewksbury-freight extra. Mass residents add
5% sales tax. Write for **FREE CATALOG.**

Circle 164 on Reader Service card.

Circle 45 on Reader Service card.

PLAY THE NUMBERS GAME — AND WIN

With **ELF** and **TWG/ARIMA** STATISTICAL SOFTWARE

TWG/

ARIMA is invaluable to users interested in time series. This Box-Jenkins package identifies

- seasonal and non-seasonal differencing
- Box-Cox transformations estimates
- correlation between coefficients
- Box-Pierce Q statistics and their significance
- t statistics
- probabilities and predicts
- various lead times
- starting points
- confidence levels for time series forecast data

\$300.00

Each program comes with database manager, numeric software keypad and requires an Apple II with Applesoft, 48 K, and DOS 3.3

To order write to
The Winchendon Group
3907 Lakota Road
P.O. Box 10114K
Alexandria, VA 22310

ELF performs

- factor analysis
 - multiple regression
 - stepwise, discriminant analysis
 - cross tabulations
 - 1 and 2 way ANOVA
- as well as all basic statistics, including skewness, kurtosis, etc. and Chi-Square. ELF will also create and edit a data base as well as visually depict data in scattergrams and histograms (bar graphs)... and more
- \$200.00

Mastercard/VISA

THE WINCHENDON GROUP

(703) 960-2587

✓ CHECK US FIRST! for DISCOUNT TRS-80® COMPUTERS

BUY DIRECT

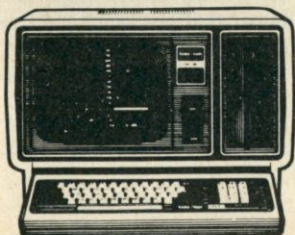

- ✓ No Out-of-State - Taxes - Kansans Add 4%
- ✓ Large Inventory for Immediate Shipment
- ✓ 100% TRS-80® Equipment
- ✓ Convenient Order Number
- ✓ F-48 Form Provided

TRS-80
CALL US FOR
OUR PRICES
and PRICE List

1-800-835-9056

- ✓ Visa, Mastercard
- ✓ Wire Transfers
- ✓ Bank Cashier's
Checks & Money
Orders.

Jimscot, Inc.

1023 N. Kansas
P.O. Box 607
Liberal, Ks. 67901

Kansas Residents:
316-624-1919 (Collect)

TRS-80 is a registered Trademark of Tandy Corp.

Volkswriter

(Reviewed in InfoWorld, June 14, 1982)

System Requirements: IBM PC under IBM DOS, 128K RAM (recommended), one disk drive (minimum)

Manufacturer: Lifetree Software, Inc., 177 Webster, Suite 342, Monterey, CA 93940

Price: \$195

Comments: Volkswriter is "a mix of highs and lows," according to the review.

"Volkswriter is a complete word-processing package designed to use the features of the IBM Personal Computer," the review says.

The review says that Volkswriter does have one serious limitation. "If your system has 64K or less of RAM memory, Volkswriter probably is not for you."

Volkswriter is reasonably easy to use and handles errors well; however, the documentation is lacking in certain areas. The manual does not inform the user that 128K RAM is recommended until page 47. "This information belongs on the cover or the first page of the manual, not in appendix E," the review says. Reader Service number 411.

Datafax

(Reviewed in Peelings II, May-June 1982)

System Requirements: Apple II Plus, 64K, Runtime Pascal, 2 Disk II, optional printer, DOS 3.3

Manufacturer: Link Systems, 1640 19th St., Santa Monica, CA 90404

Price: \$199

Comments: "This is an ideal program to organize all of those notes that accumulate on your desk," according to the review.

"Commands are available at the top level of Datafax to convert Datafax data into an Apple Pascal compatible text file," the review says.

Datafax has a completely different approach to data management in that it offers free form management of relatively large volumes of textual information; however, it cannot perform such functions as mathematical computations and detailed report formatting, the review says.

"Many will find that the program will pay for itself in a short time by reducing the aggravation associated with trying to find a particular piece of information." Reader Service number 427.

Supervyz

(Reviewed in InfoWorld, June 7, 1982)

System Requirements: Any Z-80 or 8080 system, CP/M 2.2 or MP/M 1.1, 40K RAM, double-density disk drive helpful, 20 x 80 CRT screen

Manufacturer: Epic Computer Corporation, 7542 Trade St., San Diego, CA 92121

Price: \$95

Comments: "Supervyz is designed to be a user-friendly preprocessor to CP/M," according to the review. The program's menu appears on the screen and the user then types the number that indicates the desired operation.

Supervyz has a lot of little flaws and crudities, the review says, "but once it is set up properly, it does what it is intended to do." Reader Service number 422.

Antfarm is "designed to teach programming logic to beginners of all ages . . ."

The Math Machine

(Reviewed in School Microware Reviews, Winter 1982)

System Requirements: 48K bytes, Apple II, Applesoft in ROM, one disk, printer optional

Manufacturer: SouthWest EdPsych Services, Inc., PO Box 1870, Phoenix, AZ 85001

Price: \$79.95 (two copies provided)

Comments: The Math Machine "gives practice in working elementary math problems ranging from pre-math skills to division," according to the review.

"The Math Machine is a high-quality program. The advantages include a clearly written, comprehensive manual, sequential performance objectives and a teacher-specified reinforcement schedule," the review says.

Each student is allowed to work at his own pace and receives immediate feedback for each response.

The program makes "good use of graphics color and sound," the review says. The program allows a "reasonable number of wrong answers, and responds appropriately to excessive wrong answers," according to the review. Reader Service number 408.

Vectors & Graphics

(Reviewed in Peelings II, April 1982)

System Requirements: Apple ROM, 48K bytes, Disk II, DOS 3.3

Manufacturer: Cross Educational Software, PO Box 1536, Ruston, LA 71270

Price: \$10

Comments: Vectors & Graphics is designed to be used with a high school or college physics course; it is not designed to teach it, says the review.

The package offers "very little explanation or background information," says the review, so some prior physics-related courses are necessary. Vectors & Graphics is not capable of teaching with the aid of a textbook and instruction.

The program has a short quiz section; however, these questions assume the student has some knowledge not available through the program.

"The program is very poorly error trapped," according to the review. For example, if the student hits reset, "he is knocked out of the program and must start over," says the review.

This program could be useful if a good textbook and instruction were also provided. Reader Service number 400.

Image

(Reviewed in InfoWorld, June 14, 1982)

System Requirements: Z89 or Z90, CP/M 2.2, 48K bytes of RAM, two 5¼- or eight-inch disk drives, and letter quality printer

Manufacturer: Computer Development, Inc., 6700 SW 105th St., Beaverton, OR 97005

Price: \$295

Comments: "Image is a word/graphic-processing system that lets you create bar charts, diagrams and block lettering intermixed with normal text," says the review.

The review calls Image "a complete word processor, because it lets you create a text file and print it out in one operation with one program."

Image offers "superb, professionally done" documentation and impressive support. "How many companies have a toll-free number that you can call to get immediate responses to your queries?" the review asks. Reader Service number 404.

Micro-Painter

(Reviewed in InfoWorld, July 26, 1982)

System Requirements: Atari 800, 48K RAM, one disk drive, joystick

Manufacturer: Data Soft, Inc., 19519 Business Drive, Northridge, CA 91343

Price: \$34.95

Comments: "Micro-Painter lets you design and paint original pictures;" it can also be used as an "electronic coloring book," because the diskette comes with nine pre-drawn pictures for you to color, according to the review.

The only flaw, according to the review, is that the documentation is misleading in places. Reader Service number 449.

FOLLOW THE STAR
NorthStarTM
STOCK MANAGER

Complete system for securities data-base and reporting system. Provides a variety of reports, including IRS schedule D, that permit selection of data on security name, dates, status of holding, or broker in any combination. Includes data on share price, commissions, taxes. Includes separate sort program.

Requires 40K. Written in NorthStar Basic. Also available in CBASIC 2. Please specify configuration.

Price \$49.95. First Class Postage Inc. CT Residents include 7.5% tax.

WSR SOFTWARE ASSOCIATES
55 Lantern Road, Fairfield, CT 06430

IBM PC® — MX-80®
OSBORNE I® — MX-80®

\$35.00
PARALLEL PRINTER CABLES

Our printer cable is designed to connect the IBM PC® parallel printer adapter or the OSBORNE I® IEEE 488 port with the Epson MX-80 parallel model printer (or any similar parallel printer). Why pay \$75.00?

—FREE SHIPPING—
We accept VISA, MASTERCARD, COD, CHECK
Add \$2.00 C.O.D. Charges, TX RES add 5% sales Tax

AUSTIN COMPUTER TECHNOLOGIES
Dept M P.O. Box 26595
Austin TX, 78755
512-835-6136

SOFTWARE & NEWS

FOR MICROPOLIS S-100, INCL. VECTOR GRAPHIC, EXIDY, CDS, COMPAL, BLACKHAWK, IMSAI, and the 16-sector TANDON & TEAC.

MDOS & CPM Languages, Util's, Appic's, Games
Price List - Free Catalog - \$2.00

BASIC/S & Z Compilers\$345
Accounting S/W - A/R, A/P, G/L, INV.
 PAY, Order Entry \$140-\$350
Data Base Management \$50-\$450
Mail System \$50
Assembly Language Sorts - called from Mp
 Basic or Basic-80 \$75
MDOS to CP/M, CP/M to MDOS translator and
 disk utilities \$150
Word Processors \$125-\$500
Micropolis/Vector Graphic Users Group
 Monthly newsletter, S/W discounts... \$18
 Library disks (MDOS & CP/M) \$3-\$10

Products postpaid to N. Amer. Add \$7 elsewhere. All funds in U.S. \$ VISA & MC accepted. Deduct 5% for cash.

DAMAN (205) 881-1697
Ste. 202, 604 Springwood Cr., Huntsville, AL 35803

PRICE BREAK
EPSON
MX-100
ZIP BOX REFILLS DESIGNED TO FIT
EPSON MX-100 CARTRIDGE

\$9.95
EA.

\$107.46 per dozen
Minimum Order 3 Ribbons
Price Includes Shipping
We accept Mastercard and Visa

CHECK-MATE™
P.O. BOX 103, RANDOLPH, MA 02368
Call Toll Free - 1-800-343-7706
In Massachusetts - 617-963-7694

Scotch®
Diskettes



Top-quality Scotch® Brand Diskettes from **Tech•Data**, your complete word and data processing supply center. Dealer inquiries invited.

Call Toll Free
1-800-237-8931.
In Florida, call
813-577-2794.

Tech•Data Corporation
3251 Tech Drive North
St. Petersburg, FL 33702

ZENITH/Heath
Users



Double Your
5 1/4" disk storage
capacity without adding a drive.

Get twice as much from your H88 or H89 microcomputer. Our FDC-880H floppy disk controller, in conjunction with your 5 1/4" drives, for example, expands memory capacity from 256 bytes to 512 bytes per sector.

And it handles single and double-sided, single and double-density, 8" and 5 1/4" drives — simultaneously.

Call 714/275-1272 today or write for details.

C. D. R. Systems Inc.
Controlled Data Recording Systems, Inc.
7667 Vickers St., San Diego, CA 92111

MODEM
\$129.95

No other acoustic modem gives you all these features at this low price.



The MFJ-1232 Acoustic Modem gives you a combination of features, quality and performance that others can't match at this price.

0-300 Baud, Bell 103 compatible. Originate/Answer. Half/full duplex. RS-232, TTL, CMOS level compatible. **Use any computer.** Cassette tape recorder ports save data for reloading or re-transmission. 6 pole active filter handles weak signals. Carrier detect LED indicates adequate signal strength for data recognition. Quality "muffs" gives good acoustic coupling, isolates external noise for reliable data transfer. Crystal controlled. "ON" LED. Aluminum cabinet. 110 VAC or 9 volt batteries. 9x1 1/2x4 in.

Apple II, II Plus: software and cable for modem, MFJ-1231, \$39.95. Plugs into game port. No serial board needed.

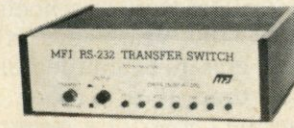

It's like having an extra port **\$79.95**

MFJ-1240 RS-232 TRANSFER SWITCH. Switches computer between 2 peripherals (printer, terminal, modem, etc.). Like having extra port. **Push button switches** 10 lines (pins 2,3,4,5,6,8,11,15,17,20). Change plug or cable to substitute other lines. Push button reverses transmit-receive lines. LEDs monitor pins 2,3,4,5,6,8,20. PC board eliminates wiring, crosstalk, line interference. 3 RS-232 25 pin connectors. 7x2x6 in.

\$99.95 MFJ-1108 AC POWER CENTER. Adds convenience, prevents data loss, head bounce, equipment damage. **Relay** latches power off during power transients. **Multi-filters** isolate equipment, eliminate interaction, noise, hash. **Varistors** suppress spikes. 3 isolated, switched socket pairs. One unswitched for clock, etc. Lighted power, reset switch. Pop-out fuse. 3 wire, 6 ft. cord. 15A, 125V, 1875 watts. Aluminum case. Black. 18x2 1/2x2 in. **MFJ-1107, \$79.95.** Like 1108 less relay. 8 sockets, 2 unswitched. **Other models available, write for free specification sheet.**

Order from MFJ and try it. If not delighted, return within 30 days for refund (less shipping). One year unconditional guarantee.
Order yours today. Call toll free 800-647-1800.
Charge VISA, MC. Or mail check, money order. Add \$4.00 each for shipping and handling.

CALL TOLL FREE ... 800-647-1800
Call 601-323-5869 in MS, outside continental USA

MFJ ENTERPRISES, INCORPORATED
921 Louisville Road, Starkville, MS 39759

Class of '82

Educational software is getting better—but don't trash the textbooks yet. Producers still have a lot to learn.

By Lloyd R. Prentice

Current statistics from credible sources are probably the best indicators of growth in the educational software field. But I have another metric. I visit my friend Rick.

Rick first called me some 18 months ago. "My company is thinking about distributing software to schools. Can you recommend products that we should add to our line?"

I was impressed. Rick's company had been selling stuff to schools for more than 100 years—everything from chalk erasers to shuttlecocks.

At that time Rick's office was tucked in the corner of a cavernous warehouse. We threaded down aisles of storage racks that groaned under pallets of blackboards and pencils and scissors and paste, and we entered a space the size of a roomy broom closet. "Our new microcomputer area," Rick announced proudly.

By my next visit the stroll to Rick's area was shorter and less of an adventure. Rick had a new assistant and new space. Their two desks seemed lost in the expanse of the new office.

During my third visit carpenters were hammering away in an adjacent area installing floor-to-ceiling shelves. "Storage for our inventory of software and books," Rick told me. He introduced me to his new secretary.

With each visit I watched the floor of Rick's domain disappear under desks and racks and computer stations. Rick introduced me to the manager of his new retail outlet and hinted at big deals brewing.

My last visit with Rick was just a few days ago and it's clear that lack of space is again crimping his style. My mind flashed back to the cavernous warehouse and for an instant I saw

pallets of floppy disks and three-ring binders piled to the fluorescent fixtures high above my head.

There are both pessimists and optimists in the educational software field. One publisher told me that schools just don't have money for software. But Talmis, a respected market research firm, sees sales growing from near zip three years ago to some \$75 million by 1985. Certainly my visits with Rick affirm that sales are on the rise. But the big question is—just what is being sold? What's available to help kids learn and how good is it? Progress in these areas is not so easy to gauge.

Recently my company did a detailed survey of the hardware and software products available to educators. We identified 1004 separate software products targeted for grades K through 12. This number, in fact, is misleading since many of the products that we turned up are actually series that include 10, 20 or 30 different units. So we're talking about maybe 1500 to 2000 separate programs. We found programs for art and music, computer literacy, early childhood, guidance, language arts and reading, library skills, mathematics, science, social science, special education and vocational and business education. We also found programs for instructional management and various "authoring" systems to make the process of developing instructional software less of a chore.

These 1004 packages were produced by some 217 companies—169 produce software exclusively, 30 produce both hardware and software and 18 produce both software and books. From the point of view of

quantity, then, producers are tripping over one another to get the product out and they seem to be cranking out something for everyone.

But what about quality? How good is the stuff? Here we plunge into a bucket of worms.

There are two sides to the quality question in educational software—technical quality and pedagogy. Technical quality comes down to questions like these:

- Does it run?
- Is it easy to use?
- Are the screens clear, easy to read, appropriately illustrated?
- Is the branching logic correct?
- Is the documentation complete, easy to use and correct?

Pedagogy is somewhat stickier. Indeed, the issue of appropriate pedagogy is the Falkland Islands of education. One camp is looking for structured presentation of content, explicit instructional objectives, accountability and emphasis on basic skills. Another camp wants to create a rich environment of information and tools and leave the learning to the innate curiosity, creativity and "constructionist" instincts of the child. This camp believes that children "construct" their own knowledge at their own pace out of their personal experiences with the physical and social environment.

Clearly, your basic philosophy of education will influence your approach to software development and evaluation.

Lloyd R. Prentice is president of Prentice Associates, Inc., 46 St. Johns St., Boston, MA, a software development and consulting company.

NEW! TPM* for TRS-80 Model II
NEW! System/6 Package
Computer Design Labs

Z80* Disk Software

We have acquired the rights to all TDL software (& hardware). TDL software has long had the reputation of being the best in the industry. Computer Design Labs will continue to maintain, evolve and add to this superior line of quality software.

— Carl Galletti and Roger Amidon, owners.

Software with Manual/Manual Alone

All of the software below is available on any of the following media for operation with a Z80 CPU using the CP/M* or similar type disk operating system (such as our own TPM*).

for TRS-80* CP/M (Model I or II)
 for 8" CP/M (soft sectored single density)
 for 5 1/4" CP/M (soft sectored single density)
 for 5 1/4" North Star CP/M (single density)
 for 5 1/4" North Star CP/M (double density)

BASIC I

A powerful and fast Z80 Basic interpreter with EDIT, RENUMBER, TRACE, PRINT USING, assembly language subroutine CALL, LOADGO for "chaining", COPY to move text, EXCHANGE, KILL, LINE INPUT, error intercept, sequential file handling in both ASCII and binary formats, and much, much more. It runs in a little over 12 K. An excellent choice for games since the precision was limited to 7 digits in order to make it one of the fastest around. \$49.95/\$15.

BASIC II

Basic I but with 12 digit precision to make its power available to the business world with only a slight sacrifice in speed. Still runs faster than most other Basics (even those with much less precision). \$99.95/\$15.

BUSINESS BASIC

The most powerful Basic for business applications. It adds to Basic II with random or sequential disk files in either fixed or variable record lengths, simultaneous access to multiple disk files, PRIVACY command to prohibit user access to source code, global editing, added math functions, and disk file maintenance capability without leaving Basic (list, rename, or delete). \$179.95/\$25.

ZEDIT

A character oriented text editor with 26 commands and "macro" capability for stringing multiple commands together. Included are a complete array of character move, add, delete, and display function. \$49.95/\$15.

ZTEL

Z80 Text Editing Language - Not just a text editor. Actually a language which allows you to edit text and also write, save, and recall programs which manipulate text. Commands include conditional branching, subroutine calls, iteration, block move, expression evaluation, and much more. Contains 36 value registers and 10 text registers. Be creative! Manipulate text with commands you write using Ztel. \$79.95/\$25.

TOP

A Z80 Text Output Processor which will do text formatting for manuals, documents, and other word processing jobs. Works with any text editor. Does justification, page numbering and headings, spacing, centering, and much more! \$79.95/\$25.

MACRO I

A macro assembler which will generate relocateable or absolute code for the 8080 or Z80 using standard Intel mnemonics plus TDL/Z80 extensions. Functions include 14 conditionals, 16 listing controls, 54 pseudops, 11 arithmetic/logical operations, local and global symbols, chaining files, linking capability with optional linker, and recursive/reiterative macros. This assembler is so powerful you'll think it is doing all the work for you. It actually makes assembly language programming much less of an effort and more creative. \$79.95/\$20.

MACRO II

Expands upon Macro I's linking capability (which is useful but somewhat limited) thereby being able to take full advantage of the optional Linker. Also a time and date function has been added and the listing capability improved. \$99.95/\$25.

LINKER

How many times have you written the same subroutine in each new program? Top notch professional programmers compile a library of these subroutines and use a Linker to tie them together at assembly time. Development time is thus drastically reduced and becomes comparable to writing in a high level language but with all the speed of assembly language. So, get the new CDL Linker and start writing programs in a fraction of the time it took before. Linker is compatible with Macro I & II as well as TDL/Xitan assemblers version 2.0 or later. \$79.95/\$20.

DEBUG I

Many programmers give up on writing in assembly language even though they know their programs would be faster and more powerful. To them assembly language seems difficult to understand and follow, as well as being a nightmare to debug. Well, not with proper tools like Debug I. With Debug I you can easily follow the flow of any Z80 or 8080 program. Trace the program one step at a time or 10 steps or whatever you like. At each step you will be able to see the instruction executed and what it did. If desired, modifications can then be made before continuing. It's all under your control. You can even skip displaying a subroutine call and up to seven breakpoints can be set during execution. Use of Debug I can pay for itself many times over by saving you valuable debugging time. \$79.95/\$20.

DEBUG II

This is an expanded debugger which has all of the features of Debug I plus many more. You can "trap" (i.e. trace a program until a set of register, flag, and/or memory conditions occur). Also, instructions may be entered and executed immediately. This makes it easy to learn new instructions by examining registers/memory before and after. And a RADIX function allows changing between ASCII, binary, decimal, hex, octal, signed decimal, or split octal. All these features and more add up to give you a very powerful development tool. Both Debug I and II must run on a Z80 but will debug both Z80 and 8080 code. \$99.95/\$20.

ZAPPLE

A Z80 executive and debug monitor. Capable of search, ASCII put and display, read and write to I/O ports, hex math, breakpoint, execute, move, fill, display, read and write in Intel or binary format tape, and more! on disk

APPLE

8080 version of Zapple

NEW! TPM now available for TRS-80 Model III!

TPM*

A NEW Z80 disk operation system! This is not CP/M*. It's better! You can still run any program which runs with CP/M* but unlike CP/M* this operating system was written specifically for the Z80* and takes full advantage of its extra powerful instruction set. In other words its not warmed over 8080 code! Available for TRS-80* (Model I or II), Tarbell, Xitan DDDC, SD Sales "VERSA-FLOPPY", North Star (SD&DD), and Digital (Micro) Systems. \$79.95/\$25.

SYSTEM MONITOR BOARD (SMB II)

A complete I/O board for S-100 systems. 2 serial ports, 2 parallel ports, 1200/2400 baud cassette tape interface, sockets for 2K of RAM, 3-2708/2716 EPROM's or ROM, jump on reset circuitry. Bare board \$49.95/\$20.

ROM FOR SMB II

2KX8 masked ROM of Zapple monitor. Includes source listing \$34.95/\$15.

PAYROLL (source code only)

The Osborne package. Requires C Basic 2.
 5" disks \$124.95 (manual not included)
 8" disks \$ 99.95 (manual not included)
 Manual \$20.00

ACCOUNTS PAYABLE/RECEIVABLE (source code only)

By Osborne. Requires C Basic 2
 5" disks \$124.95 (manual not included)
 8" \$99.95 (manual not included)
 Manual \$20.00

GENERAL LEDGER (source code only)

By Osborne. Requires C Basic 2
 5" disks \$99.95 (manual not included)
 8" disks \$99.95 (manual not included)
 Manual \$20.00

C BASIC 2

Required for Osborne software. \$99.95/\$20.

SYSTEM/6

TPM with utilities, Basic I interpreter, Basic E compiler, Macro I assembler, Debug I debugger, and ZEDIT text editor.

Above purchased separately costs \$339.75
 Special introductory offer: Only \$179.75 with coupon!!

\$160.

This Coupon is Worth
 One Hundred And Sixty Dollars
 Toward The Full Price Of The
 SYSTEM/6 Package
 System/6 with this coupon is only \$179.95.
 This is a limited time offer.

\$160.00

ORDERING INFORMATION

Visa, Master Charge and C.O.D. O.K. To order call or write with the following information.

1. Name of Product (e.g. Macro I)
2. Media (e.g. 8" CP/M)
3. Price and method of payment (e.g. C.O.D.) include credit card info. if applicable.
4. Name, Address and Phone number.
5. For TPM orders only: Indicate if for TRS 80, Tarbell, Xitan DDDC, SD Sales (5 1/4" or 8"), ICOM (5 1/4" or 8"), North Star (single or double density) or Digital (Micro) Systems.
6. N.J. residents add 5% sales tax.

Manual cost applicable against price of subsequent software purchase in any item except for the Osborne software.

For information and tech queries call
609-599-2146

These are NEW Toll Free numbers

For phone orders ONLY call toll free
1-800-458-3491 Ext. 15
In PA only 1-800-252-3567

OEMS

Many CDL products are available for licensing to OEMs. Write to Carl Galletti with your requirements.

- * Z80 is a trademark of Zilog
 - * TRS-80 is a trademark for Radio Shack
 - * TPM is a trademark of Computer Design Labs. It is not CP/M*
 - * CP/M is a trademark of Digital Research
- Prices and specifications subject to change without notice.

DEALER INQUIRIES INVITED.



342 Columbus Avenue
 Trenton, N.J. 08629

LET'S TALK EPROM PROGRAMMING AND THE S-100 BUS!

You say your eprom programming needs are varied, but your engineering budget doesn't permit the purchase of that \$5,000-\$7,000 stand-alone programmer?

a.d.s. has the solution!

Hardware

The ads Prom Blaster eprom programming card sits on the I.E.E.E. 696/S-100 bus as an I/O device.

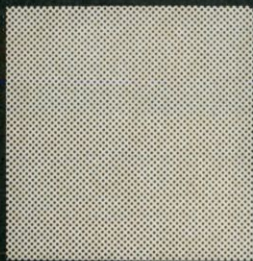

Does not require memory locations!

Handles the following devices: 2708's thru 2764's, single and three supply parts, and the Hitachi 48016 eeprom! Device plugs into on-board LIF socket.

Software

Runs under CP/m* or adsmon MC6809 monitor. Price: \$299.00 A & T + shipping. Includes board & software.

For complete details contact:

**ackerman
digital systems, inc.
110 n. york rd.
elmhurst, il. 60126
(312) 530-8992**

*CP/m
trademark
Digital
Research, Inc.



But there are more concrete dimensions of quality as well:

- Does the content fit into the curricular goals of the educator?
- Is the presentation of content consistent with established learning principles?
- Is the content factually correct?
- Are the words properly spelled and the sentences grammatically correct?
- Does the software motivate the kids?

Unfortunately I have not had the pleasure of reviewing all 2000+ educational programs that turned up in our survey. But from what I've seen there is qualitative progress in at least two areas. First, there is a greater diversity of software in terms of both content and pedagogy. And, second, the best of recent releases reflect both better use of the computer as a medium and more consideration of the user. Here are some notable developments and trends that I would submit to support my case.

High on the list is the release of Logo for both the Apple and the Texas Instruments machines. Logo is a computer language developed at MIT. Its roots are in Lisp, artificial intelligence and the child psychology of Jean Piaget. It's easy for youngsters to master and offers significant expressive power. Versions of Logo for the Apple are available from Terrapin, Inc., Krell Software and Apple Computer Systems, Inc. Logo for the TI machine is available from Texas Instruments. Logo has inspired various other "turtle graphics" systems—Atari Pilot, and Tom Smith's Kidstuff are two examples. The availability of Logo provides a powerful alternative to the tutorial and drill-and-practice modes of computer-assisted instruction.

Another trend is the reworking of drill-and-practice programs into arcade-game formats. Examples are Master Type from Lightning Software, the Arcademic series from Developmental Learning Materials, and Reston's Multiploy. Many of these programs are too martial for my taste, but kids eat them up. This development is important for two reasons. First, it reflects an attempt to understand and exploit the motivational value of the computer and, second, it requires producers to understand more fully the potential of the computer as an expressive medium.

There is also a trend toward simulations. This encourages me for many of the reasons that I've already cited.

The Search Series from McGraw-Hill is a hot property right now. The Search Series, developed by Tom Snyder of Massachusetts, helps teach social studies and problem-solving. A strong feature is that each program is designed to encourage group participation.

The Search programs are impressive from the point of view of creative pedagogy, but they are less impressive technically. Take the technical legerdemain of the arcade games and mix it with Tom Snyder's structure and you'd have *some* learning experience. In our survey we found an impressive number of simulations in both the science and social science areas.

Still another trend is the development of educational materials for the home. Most major publishers are eyeing this area carefully and a few, like Reader's Digest, are moving ahead with actual products. Educational programs for the home market must have high entertainment value, must be technically flashier than their counterparts for the classroom and generally have less thorough documentation and instructional management. A lucrative home market increases the incentive for producing top-rate educational materials.

The last trend, which is not as dramatic as the others but is equally important, is that the overall quality of educational packages from the point of view of packaging, documentation, instructional management and user friendliness is on the rise. Two companies praised on these counts by educators I've talked with are Milliken Publishing and Hartley Software. When one publisher establishes new benchmarks of quality in these areas, other publishers will have to meet or exceed them to remain competitive.

Last year (September 1981 *Microcomputing*, p. 86) I wrote that the educational software field is booming. Nothing has changed my mind. There are still problems—uneven quality, inadequate reviewing mechanisms, fragmentary offerings that fail to provide systematic coverage of a given curriculum area. Educators are still plagued with inadequate hardware and the lack of standardization of graphics, disk formats and operating systems. And producers are still vexed by piracy. But in two years the field has come a long way. I see a most promising future. ■

“THROW AWAY MY BACK ISSUES?.. ..NEVER!”



According to a recent survey, 92% of MICROCOMPUTING's readers keep their back issues.

Why is that?

We can think of two possibilities.

- 1) They think a complete edition of MICROCOMPUTING will someday be very valuable.
- 2) They think every single copy of MICROCOMPUTING already is very valuable.

Well, we're very proud of MICROCOMPUTING, and we think of it as one of the highest quality magazines around, but even we have a hard time believing the first reason.

That leaves reason number 2) which makes us ask "What makes MICROCOMPUTING so valuable?" And the answer?

Information. The kind of information that has application to today's world. The kind of information that doesn't outlive its usefulness. The kind of information our readers will want to refer to again and again—programs, applications, hardware reviews, software reviews, new product announcements, articles on language, education, business, utility, and so much more. MICROCOMPUTING is the all-encompassing monthly journal that takes you beyond the limits of your system manufacturer's documentation into an entirely new and exciting world of microcomputing. Special emphasis is placed on the Apple, Atari, Commodore, Heath, and IBM systems.

But whatever your system, you'll find the information contained in MICROCOMPUTING to be invaluable from the day you receive your first copy until the day microcomputers disappear from the face of the earth . . . and the Moon, and Mars, and Venus, and . . . well, until a long time from now.

Start your own collection of MICROCOMPUTING. Get one year's subscription for only \$24.97. That's less than 7¢ a day. That's not much to invest when you

consider the wealth of information you receive in return. And who knows . . . maybe reason 1) is true after all.

To receive your 12 monthly issues of MICROCOMPUTING, simply fill in the attached reply card or the coupon below (a photocopy is acceptable) and send it to MICROCOMPUTING, Subscription Department, PO Box 997, Farmingdale NY 11737. Or call toll free 1-800-258-5473.

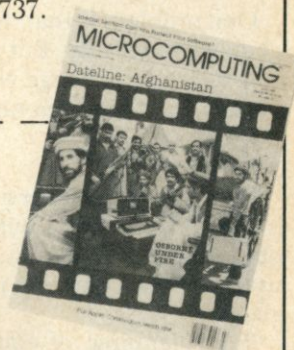

Yes, I want to start my own collection of MICROCOMPUTING

check enclosed for 12 issues of *Microcomputing* for only \$24.97

Bill ME VISA MC AMEX

Card# _____ Exp. Date _____

Signature _____

Name _____

Address _____

City _____ State _____ Zip _____

Canada and Mexico \$27.97, one year only. US funds. Foreign \$44.97, one year only. US funds drawn on a US bank. Please allow 6-8 weeks delivery.

Box 997 • Farmingdale, NY 11737

MICROCOMPUTING

A WAYNE GREEN PUBLICATION

329B7

Micros on Campus

Will we plan for their arrival or be caught by surprise?

By Thomas Wm. Madron

Colleges and universities have not dealt well with computer technology. Computer installations cost more than schools are accustomed to spending, so administrators are authorizing large sums of money for something they barely understand. This, combined with poor planning, has seriously inhibited effective use of microcomputers in the academic world.

One problem is that the technology changes so rapidly. But you can forecast the rate of change well enough to do short- and medium-range planning.

Failure to Plan

Colleges and universities are buying microcomputers with or without planning. The issue is: will they be used with a coherent policy or neglected?

Poor planning, of course, leads to waste, duplication and inefficiency; most importantly, the micros are not available for general use. One well-known university, for example, found that it had acquired 350 computers, virtually none of which was accessible to the college community.

In such a situation microcomputers will be in the custody of those politically astute enough to acquire them. Those who need them most may have no access at all.

Computing in higher education, as elsewhere, is moving away from batch processing to on-line, interactive systems for both administrative and academic computing. Today we have available to us a greater variety of computing hardware and software

than ever before, and this variety is leading to much confusion. A planning time-line should stipulate the distribution between batch processing and interactive processing now, what it is likely to be in one year and what it should be in five years. Interactive computing itself can then be subdivided by asking what share should be processed by smaller decentralized systems (microcomputers).

During the seventies the "economy of scale" argument led to the use of very large, centralized systems. Economy is now likely to lead us to decentralized, distributed and relatively specialized systems. It is at this point that microcomputers will come into their own in higher education.

Focus on Software

Too frequently, decision-makers have focused on hardware rather than on its functions. But the first step should be to identify the functions to be performed and how those functions can be performed most efficiently.

In higher education we may come to different conclusions if we are dealing with academic computing as opposed to administrative computing. There is, however, a role for microcomputers on both sides of the fence.

Some problems, of course, require computing resources that are simply beyond the capabilities of microcomputers today: Problems that require large, reasonably fast, matrix solutions (necessitating large amounts of memory), or problems that require

access to large data files, are examples. Sometimes, however, there can be cooperation between large and small computers, with small computers handling problems at the beginning or end of the process while large computers provide intermediate, large-scale processing. This implies that microcomputers on the college campus should have communications capabilities and access to centralized facilities.

Some problems, on the other hand, can be handled directly by small computers. Planning, for example, using budget simulations, linear programming, Markov analysis and forecasting tools, can often be done on microcomputers. Thus, a planning officer, currently doing computations by hand can be given inexpensive personal productivity tools not heretofore available.

Academically, obvious areas for applications include teaching programming languages, which, with a properly structured microcomputer laboratory, could be both more structured and more individualized than is presently true. Likewise, computer-assisted instruction, resisted on large centralized systems because of the resources required, can be effective on small dedicated systems. Unfortunately, most labs are merely rooms full of microcomputers rather than

Address correspondence to Dr. Thomas W. Madron, The Computing Center, North Texas State University, NT Box 13495, Denton, TX 76203.

centers of integrated technology.

When using any computer system, and particularly when using microcomputers, we should first be concerned with the availability of software for the job, then seek hardware to run that software. It would also be well to limit the variety of hardware to those manufacturers that can provide adequate service in a given locale. We might deviate from such a rule when considering microcomputers for process control in laboratories and similar situations.

Before deploying microcomputers, an institution should provide technical support (both software and hardware) for the systems. This support need not be as extensive as it is when a microcomputer lab is part of a computer science department. At other times support may be a major problem. I am familiar with no instance of a college or university realistically facing this issue, and it is exacerbated by individuals and departments acquiring computers through independent funding. Consequently, after spending large amounts of money, you may find that the micro has become a dust collector.

One way around this is to establish multiple-microcomputer laboratories rather than spreading machines around in departmental, faculty or administrative offices. Early provision of some machines for development purposes might reduce later problems.

Microcomputers in a Distributed-Computing Environment

If computers are to be used properly, central planning and support is needed. This is especially true if the intent is to provide a distributed-computing environment that will require standardized software allowing computers to properly communicate with one another. While it is not easy to ensure that each microcomputer has appropriate communications software, it's not an overwhelming problem. If a total computing system is being developed, the system's components should be able to do their tasks and then send the results in manageable form to the end user.

Universities have, typically, not designed distributed-computing systems. But the "economy of scale" argument has less impact now than it once did.

Moreover, timesharing is often a zero-sum game; that is, a resource I acquire is a resource not available to

anyone else. This is especially true of either dedicated or dial-up ports. If I capture a port on a large system, that port is denied to someone else. Microcomputers used in distributed systems help avoid this problem. Rather, we establish a situation that maximizes everyone's ability to use a total system.

The Economy of Microcomputers

Microcomputers can effectively be used to supplement timesharing systems. A typical terminal work station for a large timesharing system includes a *cheap* terminal, a port, part of a controller, system software and can cost some \$7000. A complete microcomputer work station.

The implication is that, used appropriately in a properly planned environment, microcomputers can lead to more effective use of all the computing resources available. Even if we do not choose to establish a distributed-computing system, an integrated approach is still desirable. And in the small college where no large system is available, microcomputers can provide an economic means for making some computing available.

Conclusions

When considering microcomputers, it is important that academic institutions recognize them as tools with potential applications to all disciplines. While computer-science and information-systems programs have special computing needs, academic computing facilities should not be deployed solely for the convenience of these professional programs.

Higher education must confront microcomputers partly in self-defense. Microcomputers are now being widely used in secondary schools throughout the United States. As a result, the demand for quality instruction using computing will be greater in the near future than in the past. Soon entering freshmen will have the technical competence and skill currently imparted in introductory computer-science and/or information-systems courses. Those students will be demanding more than we can currently deliver. We are in much the same situation as higher education must have been in during the first few years following Gutenberg's invention of the printing press. And we must plan for the changes that will take place *with or without us*. ■

Circle 78 on Reader Service card.

EXPOTEK

2723 W. Windrose • Suite 3
Phoenix, Arizona 85029
1-800-528-8960

GUARANTEED LOW PRICES

APPLE CARDS

16K RAM — \$99 Z80 CARD — \$279
Videx Card — \$249 Smart Term — \$179
32K Atari Card — \$99.50 Clock CARD — \$229

ALTOS

5-15D — \$2290 5-5D — \$4399

ANADEX

9500A — \$1290 9501A — \$1290

ATARI

400-16K — \$289 800-16K — \$659
410 — \$79 810 — \$435
825 — \$569 850 — \$149

CITOM

F-10P — \$1380 F-10S — \$1525

Prowriter

8510AP — \$489 8510ACD — \$610

DATASOUTH

DS120 — \$595 DS180 — \$1259

DIABLO

630RO — \$1945 620 — \$1295

EPSON

MX80FT — \$515 MX80 — \$439
MX100 — \$699 Graphic Rom — \$45

HAZELTINE

1500 — \$995 ESPRIT — \$515

MICRO SCI A2

\$350 — Apple Drive/Card — \$400

MODEMS

HAYS — MICROMODEM — \$290
HAYS — SMARTMODEM — \$229
Penril — 300/1200 (212A) — \$695

MONITORS

BMC Green — \$95 Color RGB — \$550
Amdek 3000 — \$159 Color — \$380
Sanyo-Green — \$225 Color — \$335

NORTHSTAR

Advantage — \$2795 Horizon 64QD — \$2795

NEC

8023 — \$489 7710 — \$2350

MPI

88G — \$550 99G — \$650

SOROC

120 — \$659 135 — \$689

TELEVIDEO

910 — \$569 925 — \$730
920 — \$735 950 — \$915

TI

810 — \$1240 820 — \$1795

ZENITH

Z19 — \$699 Z89 — \$2129

OKIDATA

M80 — \$320 M83A — \$699
M82A — \$425
M84P — \$1059 M84S — \$1225

SOFTWARE

All Major Brands — SCALL

DISKETTES/BOXES

Elephant — \$20 Scotch — \$25 Dysan — \$35

All Prices Subject To Change

Customer Service
602-863-0759

Future Trends Take Shape at NCC

Columnist Frank Derfler reports from the Lone Star state that micro systems are becoming more powerful, and designed for the microcomputerist on the move.

By Frank J. Derfler, Jr.



The Epson HX-20 portable microcomputer has a full-function keyboard, RAM and ROM, RS-232C interface and four-line by 20 character display screen packed into a box the size of this magazine. An optional microcassette recorder and printer can be contained within the same package. Internal batteries provide up to 50 hours of operation. The list price of the basic unit is \$799. The CX-20 companion modem (\$149) is battery operated and completely portable.

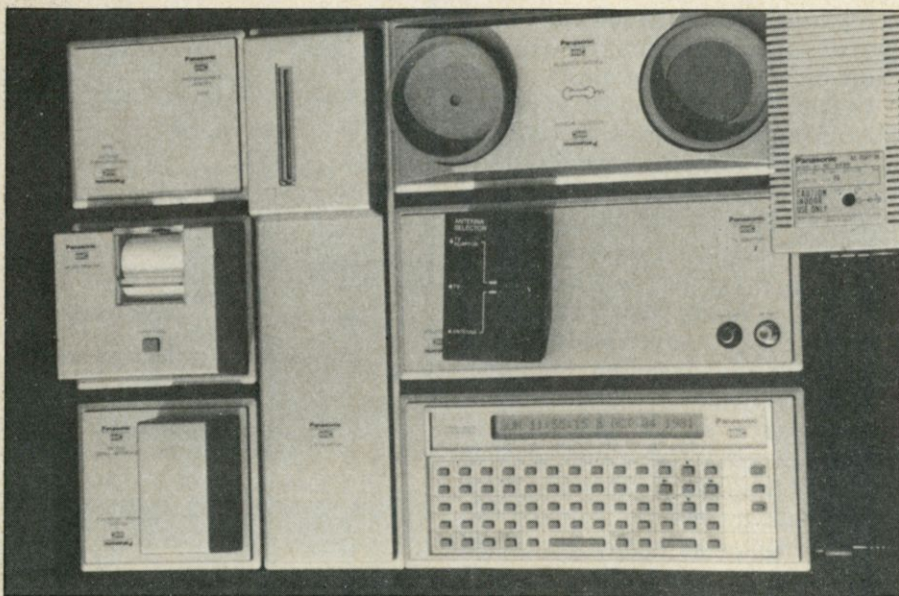

The Panasonic Hand Held Computer as it was displayed at the NCC. The modem, television video adapter, extra memory, and printer are all plugged together in building block fashion. The entire unit can be carried in a briefcase.

I just returned from the National Computer Conference in Houston, Texas. The NCC is an annual event which combines the colors and sounds of a carnival with the sophistication of high technology and big business. The event consumed the convention facilities of the Astrodome and every hotel room, rental car and taxi in Houston for a week.

NCC used to be a show only for "big" computers. The lines between "big" mainframe, mini, and "small" microcomputers have now become so blurred that the distinctions hardly seem to apply anymore. Many individual exhibitors at NCC still don't understand the smaller systems and were uncomfortable with the amount of display space devoted to them. Emotions ranging from uneasiness to hostility were evident in the comments and sales pitches coming from several booths.

Other companies, such as Digital Equipment Corporation, now feature computer systems at nearly every level of power and understand how they relate. The DEC booth was one of the most popular at the show.

I think three main themes ran through the NCC exhibits that will be interesting to *Microcomputing* readers: more-portable equipment, much greater disk storage capability, and the integration of 16-bit and eight-bit processors. An interesting sub-theme was the impact of the IBM PC.

Frank J. Derfler (PO Box 691, Herndon, VA 22070) writes the monthly *Dial-Up Directory* column for *Microcomputing*.

Carry It Away

We are going to have smaller, lighter and more-portable computers and equipment. Several years ago I wrote that Americans love their mobility too much to be tied down to fixed computer systems. I described what I called the Limitation of Location. I must admit that at the time I thought automobile manufacturers might offer a multifunction (including games, appointment calendar and maybe graphic map displays) dashboard computer as an option to car buyers. The new wave of systems I saw at NCC is not tied to the automobile. These systems don't have to be tied to anything!

The Epson HX-20

The Epson HX-20 is almost exactly the size of this page of *Microcomputing*. It is 1.75 inches high and weighs less than four pounds. Into that package, Epson packs a full-size full-stroke keyboard, a four-line by 20-character liquid crystal display, 16K of RAM and 32K of ROM, cassette and cartridge interfaces and an RS-232C port for communications. (Oh yes, there's a CMOS 6301 microprocessor in there somewhere too.) In the same package, you can optionally add a 24-column impact printer, a microcassette for saving and loading programs, and 16K more RAM plus 32K more ROM.

The 20-character screen does not limit the size of the line that can be created. The screen moves around inside of the document so full word processing and programming capabilities are available. The screen displays uppercase, lowercase and graphic characters.

The keyboard has 68 keys which can generate the entire ASCII set including control codes. It also can generate 32 special graphic characters. It has five programmable special-function keys and even a phantom numeric keypad. Under a keyboard control, the U,I,O,J,K,L and M keys become a numeric entry pad for fast entry of statistical data.

Because the system uses low power CMOS technology, its four internal batteries can keep it running for up to 50 hours of operation. Heavy operation of the RS-232C interface and the motors on the printer and recorder may reduce the time between charges.

Obviously I was taken with the features of the HX-20, but there were



The Pocketerm is distributed by Charles Schwab & Co., best known as a firm of discount brokers. It is a portable terminal with a built-in modem. It provides either 110 or 300 baud communications service, and retails for about \$400.

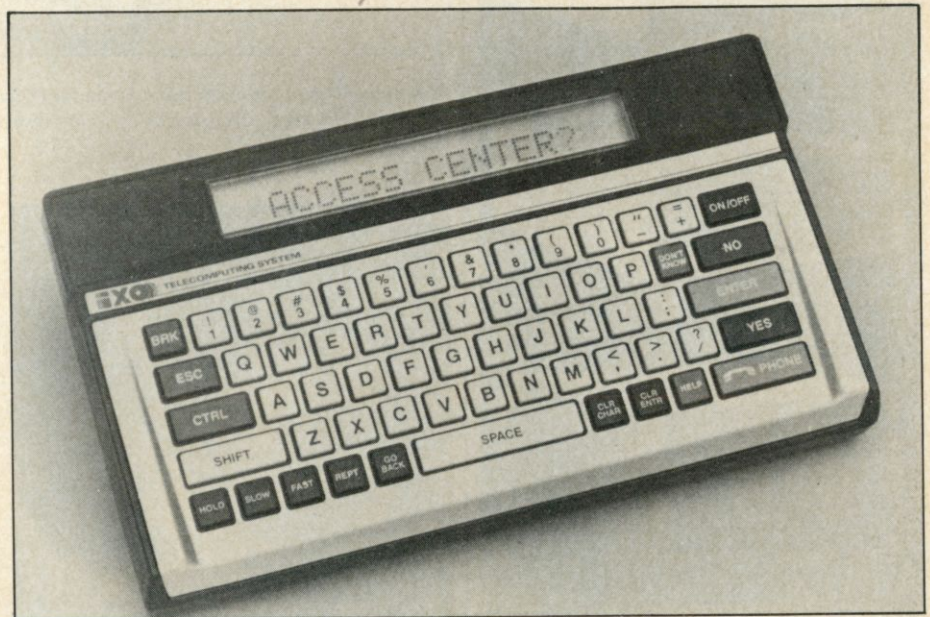

The Telecomputing System from iXO is a portable terminal with a built-in modem and auto-dialing capability. The keys identified as yes, no, don't know and help send specific multicharacter strings which speed the use of data and information services.

two items that really sold me. The first was the portable, battery-operated modem that is available as an accessory for about \$149. The second was the list price of the HX-20 itself—\$799.

The HX-20 has the potential for becoming a portable workhorse. It has a practical keyboard and useful interfaces. I wish the screen window were wider than 20 characters, but the characters are large and legible. Time will tell if the screen width becomes a limiting factor in marketing the HX-20, but I don't think it will.

Panasonic HHC

The Epson HX-20 was not the only

interesting machine in a small package. Panasonic was displaying a small, flexible and expandable system called the Link Hand Held Computer (HHC). The basic Panasonic HHC comes with a 6502 processor, up to 8K bytes of RAM and a single-line 26-character liquid crystal display, in a package about half the size of this page. It has 65 keys on its calculator-type keyboard. At first the HHC appears to be a limited "pocket" computer, but the features that set the Link apart are its expansion and communications capabilities.

The HHC expansion modules plug into the basic machine in building block fashion. The expansion

Main/Frames Main/Frames

from
\$200

- 30 Models of Enclosures
- Assembled and tested
- Quasi-Coax Motherboards
- Power Supply
- Card cage and guides
- Fan, line, cord, fuse, power & reset switches

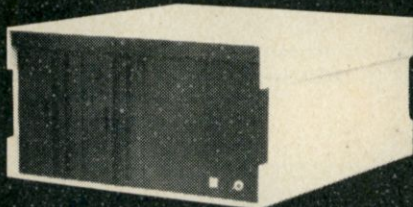

8" Floppy Main/Frame

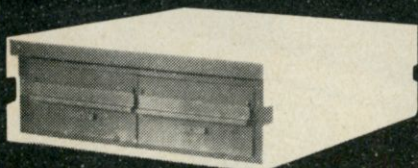

8" Disc Enclosure

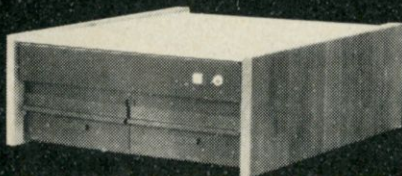

Phase/80 8" Floppy Mainframe



Phase/80 Desk + Mainframe

Write or call for our brochure which includes our application note: "Building Computers — A Recipe"

INTEGRAND

8620 Roosevelt Ave. • Visalia, CA 93291
209/733-9288

We accept BankAmericard/Visa and MasterCard

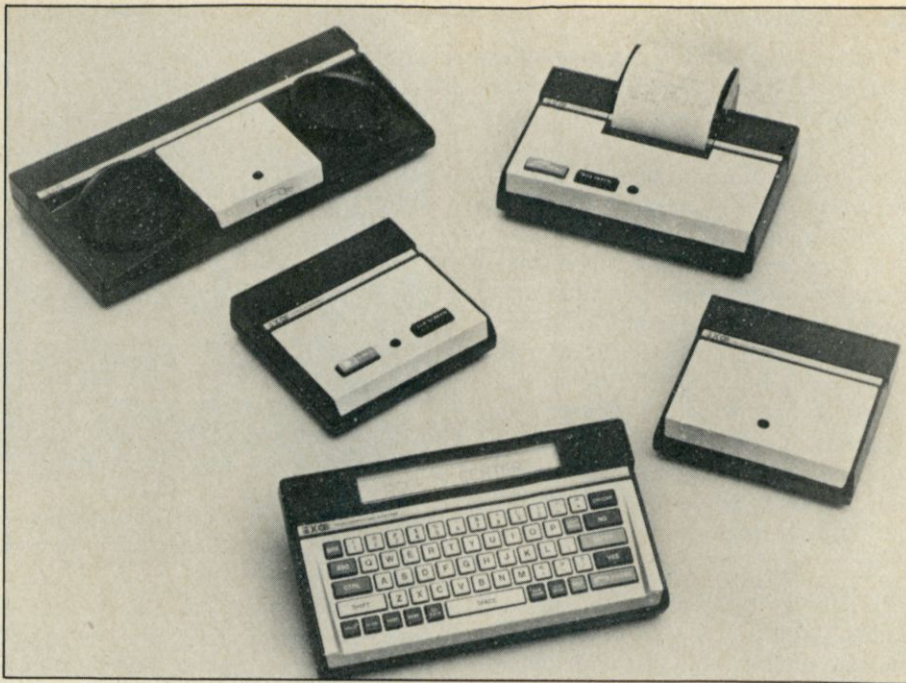

Four optional peripherals are available for the iXO telecomputing system: a dot matrix printer, a video interface that provides a 32-character by 16-line display on a television set or monitor, an RS-232C interface and an acoustic coupler.

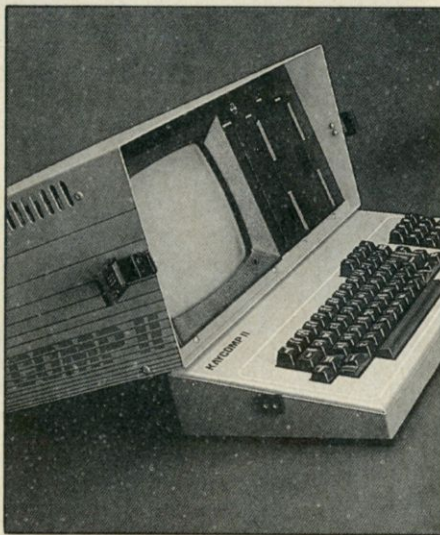

Non-Linear Systems, Inc. introduced double-density disks as a standard feature of its Kaycomp II portable microcomputer system. They claim to have generated \$7 million in sales in the first five weeks. The Kaycomp II operates under CP/M and sells at local dealers for \$1795.

modules include two different modems for communications (with and without cassette interface), two different thermal printers (40 and 15 columns), a TV adapter that feeds a modulated rf signal to a television set, cassette storage, more RAM, programmed ROM cartridges and even an attache case to carry the complete system. The system can connect directly to an impressive four-color plotter with full paper movement

and precise line definition and placement. The plotter is about 9 x 3 x 4 inches and weighs 12 ounces.

Panasonic has several communications programs for the HHC. These software packages come in small ROM modules which plug into the bottom of the machine. Telecomputing 1 turns the HHC into a dumb terminal with full ASCII transmission capability. Telecomputing 2 lets you transfer files between two HHCs or between an HHC and host computer system.

The Panasonic HHC line is not low priced and the options can add up quickly. The basic 8K Panasonic HHC has a list price of \$480. The modem with cassette interface lists for \$300. You should note, however, that the modems interface directly with the CPU bus, so the optional RS-232C serial port is not needed. A 16K RAM expansion costs \$350 and the Telecomputing 2 cartridge sells for \$39.95.

The entire HHC with all options becomes a very powerful system. The two major limitations are the size of the keyboard and the single line display. I will comment more on these limitations later because they are shared by two other new communications devices.

Two Pocket Terminals

It is apparent that the people at

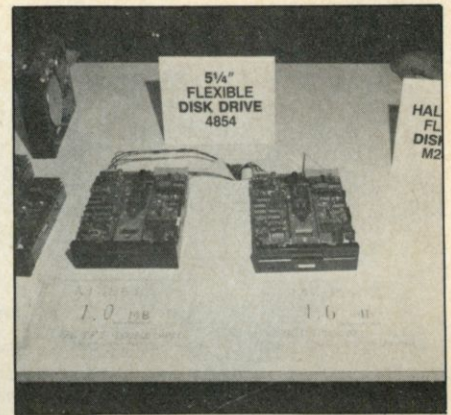

Disks continue to become smaller and more dense. Several three-inch and 3 1/2-inch drives are available that pack nearly 500K bytes onto one side of a disk. While the 5 1/4-inch drives take up more room, they also pack more data onto each disk. Mitsubishi's low-profile 5 1/4-inch drive can put 800K of data on each side of the disk. That can put 3.2 megabytes of data into each slot of a currently available machine using full size drives.

both Charles Schwab & Co. and iXO, Inc. believe the age of the pocket terminal has arrived. They have each arrived at slightly different solutions to the problem of how to balance features and price.

Pocketerm One is a small and relatively low cost pocket terminal being distributed by Charles Schwab & Co., Inc., 1 Second St., San Francisco, CA 94105. That company is a very large discount brokerage firm handling securities for clients throughout the country. Obviously, they see applications in the areas of business and investments.

Pocketerm is initially being marketed only to corporate purchasers. It is expected to be available to individuals at a suggested retail price of \$399 later this year. An optional printer will be available for \$250 and a television set adapter is planned.

The iXO Telecomputing System is a pocket terminal and operating support system marketed by iXO, Inc., 6041 Bristol Parkway, Culver City, CA 90230. The hardware portion of the system is a pocket terminal with many user-friendly features. The total service includes a unique and individually tailored automatic terminal programming service provided by iXO.

The iXO system approach makes the terminal meet the needs of each individual. The company maintains an Access Center for Telecomputing System users. Each user is supposed to call this Access Center when the

device is first activated. The center will ask the user about the systems to be used with the pocket terminal; it will then download the appropriate log-on protocols and operation parameters into the nonvolatile RAM

of the telecomputing system. After that, the user will only have to push one button to get on-line with desired host systems.

The iXO system has made on-line operation easier by including keys

Circle 283 on Reader Service card.

PROFESSIONAL WORD PROCESSOR

- ✓ Double Columns
- ✓ Right Justification
- ✓ Printer Graphics
- ✓ Variable Line Space
- ✓ Printer Control Code
- ✓ Page by Paragraph
- ✓ Line Centering
- ✓ Shorthand
- ✓ Margin Control
- ✓ Form Letters

FOR APPLE/PET/CBM
COPY-WRITER by IDPC Co.
 only \$185.00

EXCHANGE DATA w IBM 3740

PEDISK II 877 FLOPPY DISK Systems can now read and write records from IBM "Basic Data Exchange" type diskettes. FILEX software from WILSERVE does all the work! Converts EBCDIC - ASCII.

EXCHANGE System (877/FILEX) \$1295.
 PEDISK 877-1 8" Floppy for PET..... \$ 995.
 PEDISK 540-1 5" Floppy for PET..... \$ 595.
 CONTROLLER BOARD w PDOS..... \$ 229.

Commodore Communicates! COMPACK \$129.

Intelligent Terminal Package including: ACIA based interface
 DB25 cable
 STCP software

- ✓ Remote Telemetry
- ✓ Transfer to/from Disk
- ✓ Printer Output
- ✓ XON-XOFF Control
- ✓ User Program Cntl.
- ✓ Status Line

SEE YOUR DEALER OR:

MICROTECH P.O. Box 102
 Langhorne, Pa. 19047
 215-757-0284

DEALER INQUIRIES INVITED

Circle 168 on Reader Service card.

All about LOGO— how it was invented and how it works

"Changes the learning experience from a matter of discipline into one of discovery." — Marvin Minsky, MIT

"A revolutionary book... required reading for anyone with an interest in computers, children, education, or the future." — 80 Microcomputing

MINDSTORMS
 CHILDREN, COMPUTERS, AND
 POWERFUL IDEAS
SEYMOUR PAPERT

Now in paperback, \$6.95

BASIC BOOKS, INC.
 10 East 53rd Street, New York, NY 10022



This is the new Sony SMC-70 microcomputer that was released at the National Computer Conference in Houston. In this photo, two 3 1/2-inch microfloppy disk drives and an expansion module have been mounted on the basic computer. The SMC-70 is a Z-80A microcomputer with 64K of RAM. Standard interfaces include a Centronics parallel printer port, an RS-232C serial port, RGB color and black and white composite video, light pen port, key pad interface and tape cassette I/O. In this configuration, with the disks, the unit would sell for about \$2600.



This is a typical business configuration of the SMC-70. A dot matrix printer, numeric keypad, monitor and 3 1/2-inch floppy disk drives have been added to the basic computer. The Sony green screen monitor sells for \$375. A color monitor capable of accepting either RGB or composite video sells for \$895. The monitor stand is another \$60.

loaded with special commands often needed to interact with a time-sharing system. These include help, yes, no, go back and others. The yes and no keys, for instance, send either the letter Y or N and a carriage return. This allows quick single-key response to the menu questions asked by many host systems.

The iXO system is also being marketed first to large corporate users.

While no single-quantity list price was given, a thumbnail escalation of the wholesale price says that it should list for about \$500 in single quantities.

It's interesting to compare the iXO and Pocketerm systems to see the differences in both hardware and concept. Both devices are about the same size. Both display a single line of 16 characters. The Pocketerm uses a

green fluorescent display, while the iXO uses liquid crystal.

Both devices include a modem that attaches to the telephone line through a modular plug. The iXO will actually dial the telephone line using either pulse or tone dialing when the phone button is pushed. The Pocketerm has 43 keys, the iXO has 61. They both use the standard QWERTY configuration. Neither device has a full-stroke keyboard.

Both the iXO and Schwab systems have options such as printers and acoustic couplers available. Both have, or will have, video adapters. They both have a buffer which holds received data and which can be reviewed on command. The Pocketerm holds 224 characters, the iXO holds 80.

There is an interesting difference in how the two systems are powered. The Schwab terminal uses rechargeable nicad batteries good for about one hour of operation. It can also operate from an ac recharger/adapter. The iXO uses a Polaroid Polarpulse battery to keep the programmable memory alive when the system is not being used. During use, it takes its operating power from the telephone line if it is not working through an acoustic coupler.

The iXO has other features such as data security that would be of specific interest to corporate users. In common use, the major differences between the units are in the quality of external finish (the iXO is certainly prettier), the display, and the auto-dial and auto log-on capability of the iXO. The user will have to decide if those differences are worth the difference in price.

Small Displays and Big Fingers

These two very well financed corporations have decided that there is a big market for pocket terminals, and they have independently produced products with more similarities than differences. Yet both of these terminals have significant limitations in their operation. The greatest limitation is in the size of the display.

All of the pocket systems use displays that scroll, marquee style, from right to left. At 300 baud, this scrolling is simply too fast for comfortable reading with good retention. The terminals can operate at 110 baud, but this results in slow service and high bills for service and connect charges.

I have used these pocket terminals on information utilities I know very

ARE YOU OUT OF CONTROL?

OUR 6502 BASED MICROCOMPUTER HAS
EVERYTHING UNDER CONTROL.

THE COMPUTER "SLIM"

- 6502 MICROPROCESSOR
 - 2K BYTES RAM
 - 2K OR 4K EPROM
 - FOUR 8 BIT I/O PORTS
 - POWER ON RESET
 - CRYSTAL CLOCK
 - BUFFERED SYM-AIM BUS
- PRICE 81-260A **\$199.95** ASSM.
81-260K **\$149.95** KIT
81-260B \$ **39.95** BARE BOARD

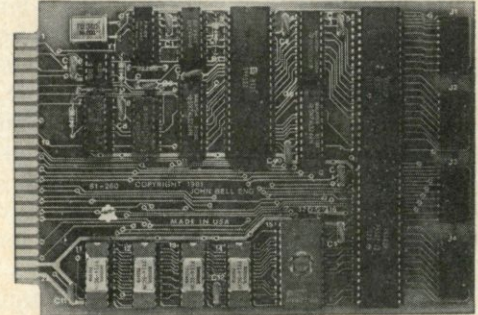

THE COMPUTER "SLIM"

THE PERIPHERALS

RAM EPROM MEMORY

- 32K BYTES OF RAM OR EPROM
- PRICE 81-330A \$ **99.95** ASSM. W/O MEMORY
81-330B \$ **49.95** BARE BOARD

6 SLOT MOTHER BOARD

- .750" BOARD SPACING 44 PIN BUS
- PRICE 81-320A \$ **99.95** ASSEMBLED
81-320B \$ **49.95** BARE BOARD

24 HOUR REAL TIME CLOCK

- FOUR DIGIT LED DISPLAY
 - ON BOARD POWER SUPPLY
- PRICE 81-350A **\$149.95** ASSEMBLED
81-350B \$ **49.95** BARE BOARD

ANALOG I/O INTERFACE

- 16 ANALOG INPUT CHANNELS
 - 2 ANALOG OUTPUT CHANNELS
- PRICE 81-292A **\$199.95** ASSEMBLED
81-292B \$ **49.95** BARE BOARD

12 PORT PARALLEL I/O BOARD

- 12 8 BIT I/O PORTS — 6 6522S
- PRICE 82-036A **\$169.95** ASSEMBLED
82-036B \$ **49.95** BARE BOARD

MONITOR + TINY BASIC 2532 **\$39.95**

ALL BOARDS ARE 4.5 X 6.5 WITH
GOLD EDGE CONNECTORS
SOLDER MASK BOTH SIDES

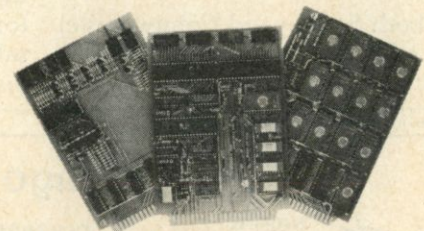

19" RACK MOUNTING

CALL 415 592-8411 FOR MORE
INFORMATION.

OUR SALES PEOPLE WILL BE
GLAD TO DEMONSTRATE OUR
PRODUCTS AT YOUR COMPANY.
OEM PRICING AVAILABLE.



JOHN BELL ENGINEERING, INC.

ALL PRODUCTS ARE AVAILABLE FROM JOHN BELL ENGINEERING, INC. • 1014 CENTER ST., SAN CARLOS, CA 94070

ADD SALES TAX IN CALIFORNIA • ADD 5% SHIPPING & HANDLING 3% FOR ORDERS OVER \$100

10% OUTSIDE U.S.A.

MC

SEND FOR CATALOG

(415) 592-8411

WILL CALL HOURS: 9am - 4pm

VISA

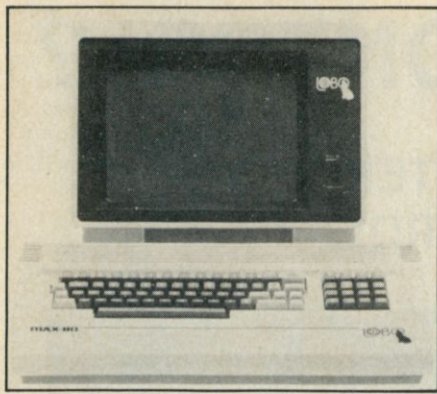

Lobo Drives International introduced their MAX-80 Computer System at NCC. This is a particularly interesting system because it will run both TRS-80 and CP/M software. TRS-80 software is run under LDOS, a TRSDOS-compatible operating system. The basic computer with 64K of RAM, flexible video display (24 lines by 80 characters or TRS-80 16 x 64 and 16 x 32 plus graphics), two serial ports and a parallel port, and a disk controller will list for \$800. The drives and monitor must be added. Lobo also introduced new systems such as eight-inch drives and a controller board for the IBM PC. Contact Lobo Drives International, 358 S. Fairview Ave., Goleta, CA 93117.

well (both Source and CompuServe) and I still find them hard to use. A CompuServe menu that makes sense

on a CRT is nearly incomprehensible when it is scrolled out along one line.

Where these pocket terminals are really used for communications, they're usually attached to television sets providing a 16-line display. If a larger display is honestly needed for good communications, why not include it in a slightly larger case in the first place?

Similarly, I consider these to be almost one-way communications devices. If I am on the road, I want to be able to send memos, letters and electronic mail back to my office. The keyboards of these pocket devices are quite frustrating to use. Entering words and sentences is very slow and prone to error. While some distributors have recognized this, and have limited the needed keystrokes, I'd rather see an honest and usable keyboard in a slightly bigger box.

I will swim against the tide and predict that, while the pocket terminals like the iXO and Pocketerm will have initial success because of their novelty and strong marketing push, in the long term real portable terminals for business executives, traveling salespeople and investors will have displays of at least four lines, full size

keyboards and off-line document review and preparation. Epson, Sony and several other manufacturers are almost there now.

Dense Disks

I said that I had found three themes in the displays at NCC, but so far I have only dealt with portability. Another trend that will have a data communications spin-off is the increasing variety of disk sizes and density. The 3½-inch disks introduced by Sony last year have been joined by a number of smaller and more dense offerings from different companies.

At least two other different 3-inch formats are coming from Japan, and Sinclair may be bringing another



The informal NCC grapevine in the food, registration and transportation lines judged the Victor 9000 to be the best integrated 16-bit business system shown at the National Computer Conference. Victor Business Products is an American company that has been selling business machines for several decades. They have 50 branches and 250 authorized dealers throughout the country. This machine uses an 8088 CPU, with room to increase memory up to 768K. The disks can put over 600K of formatted data on each side. Each machine comes with two serial and two parallel ports. The CRT features tilt and swivel movement with an anti-glare screen. The Victor 9000 is supplied with both MS DOS and CP/M-86. A unique feature of the Victor 9000 is a standard analog coder and decoder aimed primarily at digitizing and reconstructing the human voice. They state that this will be a very important feature in business machines of the future and I certainly agree. But I am surprised that they do not yet provide color graphics as an option. I believe that color will be just as important as voice recognition and voice synthesis in the future office environment. The Victor 9000, with all of these standard features and dual-sided disk drives (2.4 megabytes of storage!) is priced at \$5895. Contact Victor Business Products, 3900 North Rockwell St., Chicago, IL 60618.

Circle 228 on Reader Service card.



WA90RC

The Chicago FM Club

presents

THE 12TH ANNUAL RADIO EXPO '82

SEPT. 25TH & 26TH



computer
DISPLAYS BY MAJOR
MANUFACTURERES

**THOUSANDS OF DOLLARS
WORTH OF DOOR PRIZES**

Lake County Fair Grounds
Intersection Rts. 45 & 120
Grayslake, Illinois

"LUV-EXPO" (312) 588-3976
\$3.00 IN ADVANCE — \$4.00 AT GATE

RADIO EXPO TICKETS
P.O. BOX 1532, EVANSTON, IL 60204

Circle 177 on Reader Service card.

HEATH H8/H89 OWNERS:

H-SCOOP

The State of the Art monthly newsletter to help you get the most from your H8 or H89. *Who is doing what *Problem solvers *Reviews *Programming Goodies *Features *Reports *Software *Hardware *Disk Software Offers *MUCH MUCH MORE. Find out why H-SCOOP was rated #1! H-SCOOP! Contact with the future!

RATES: 12 issues/year for \$20 (US 1st class), \$27 Foreign Air Mail.

VISA and MC accepted. For more information or to order, write or call:

H-SCOOP

2918 S. 7th St., Sheboygan, WI 53081 (414) 452-4172

from England. The Sony 3½-inch drive can record 437.5K bytes of information (unformatted) on each side of the disk. This gives the user nearly a megabyte of storage in a very small package.

The old reliable 5¼-inch drives aren't what they used to be either. Mitsubishi has introduced a drive that can record 800K on one side of a disk. That means that a double-headed 5¼-inch drive can have over 1.6 megabytes of unformatted storage capacity. Several disk manufacturers have already introduced media certified for the Mitsubishi system.

The combination of high-density disks and the trend toward bigger RAMs makes me wonder if the trend toward hard disks will continue. The hard disks give an advantage in speed, but their mechanical and operational problems can be very great. A high-density disk and large RAM may become a better and more reliable combination in many applications.

My forecast calls for ever-increasing capabilities in the density of small drives. This means we will have an even greater hodgepodge of formats with no standards in sight. There are two practical ways to meet this prob-



The Compass Computer, a new management workstation from Grid Systems, provides decision-makers with ready access to internal and external databases. It includes an extensive array of software, nonvolatile bubble memory, a built-in modem, flat-panel bit-mapped graphics and character display—all in a 9¼-pound package small enough to fit, with room to spare, in a briefcase.

lem. The first is some practical ready standard or capability. Adam Osborne told me that by the time this article is in print the latest Osborne OS 1's will have the capability to read

Circle 302 on Reader Service card.

Software for NorthStar Users

EXPENSE PROFILE **\$29.95**

Now a program that really helps at income tax time. It summarizes expenses by categories and by person. Makes SEPARATE vs JOINT TAX RETURN comparisons simple.

Promotes frequent review of spending habits. Guided by MENU'S add new expenses, categories, and users anytime. Quickly search to any item to make changes. Store expenses on disk automatically.

DYNAMIC BUDGET **\$29.95**

Cope with rapidly changing economic conditions. Forecast effects of INFLATION on your family. CAL-NDAR built-in so recurring items like rent are entered only once.

Monthly listings of expenses, income, and balance. Change or add items anytime, data automatically stored on disk.

PATHFINDER DISASSEMBLER **\$22.50**

Z80 or 8080 code. Pauses at each jump or call to allow you to follow program or continue straight ahead. Printer & video output.

KID MATH **\$17.50**

Math drill. Watch speed, accuracy and confidence grow.

**CP/M versions
available soon**

First class postage paid in U.S. MD residents add 5% tax.

The Software Connection

10703 Meadowhill Rd.
Silver Spring, MD 20901

Dept KB

Circle 284 on Reader Service card.

NOW—A COMPLETE CP/M PASCAL—FOR ONLY

\$29.95!

Goodbye BASIC, PL/1, COBOL—hello PASCAL! Now, to make this most advanced language available to more micro users, we're slashing our price—to an amazing **\$29.95!** This astonishing price includes the complete JRT Pascal system on 8" SSSD diskette and the comprehensive new user manual. Not a subset, it's a complete Pascal for CP/M.* Check the features:

- Separate compilation of external procedures • Auto-loading
- 14 digit FLOATING POINT arithmetic • True dynamic storage
- Verbal error messages • Fast one-step compiler: no link needed
- Graphing procedures • Statistic procedures
- Activity analyzer prints histogram of program use
- Advanced assembler interface. •

THIS IS THE SAME SYSTEM WE SOLD FOR \$295!

So how can we make this offer?—why the unbelievable deal? Very simply, we think all software is overpriced. We want to build volume with the booming CP/M market, and our overhead is low, so we're passing the savings on to you.

AND AT NO RISK!

When you receive JRT Pascal, look it over, check it out. We invite you to compare it with other systems costing ten times as much. If you're not completely satisfied, return the system—with the sealed diskette unopened—within 30 days and your money will be refunded in full! **THAT'S RIGHT—COMPLETE SATISFACTION**

GUARANTEED OR YOUR MONEY BACK!

In addition, if you want to copy the diskette or manual—so long as it's not for resale—it's o.k. with us. Pass it on to your friends! **BUT ACT TODAY—DON'T DELAY ENJOYING PASCAL'S ADVANTAGES—AT \$29.95, THERE'S NO REASON TO WAIT!**



To: **JRT Systems**
1891-23rd Avenue
San Francisco, CA 94122



O.K. You've sold me—I can't resist your unbelievable offer. Send me JRT Pascal by return mail. I understand that if I'm not completely satisfied, I can return it within 30 days—with the sealed diskette unopened—for a full refund. Payment is enclosed by:

Check Mastercharge VISA Amount: \$ _____
(Shipping outside North America, \$6. CA residents add sales tax.)

Card # _____ Exp. _____

Signature _____

Name _____ Address _____

City _____ State _____ Zip _____

*CP/M is a Digital Research trademark. A 52K CP/M system is required.

BURN EPROMS USING CP/M

EPROM PROGRAMMING SYSTEM RUNS UNDER CP/M

COMMAND SUMMARY

- PROGRAM EPROM(S) FROM DISK FILE
- READ EPROM INTO RAM
- PROGRAM EPROM FROM RAM
- DISPLAY/MODIFY RAM
- READ DISK FILE INTO RAM
- VERIFY EPROM IS ERASED
- COMPARE EPROM W/ RAM
- COPY EPROM

FEATURES

- STAND ALONE SINGLE BOARD (6X7.5) PROGRAMS 2708, 2709, 2710, 2716, 2732, 2732A AND 2764 EPROMS.
- NO PERSONALITY MODULES OR DIP SWITCHES TO CHANGE
- 100% ELECTRONIC SWITCHING OF EPROM TYPES
- INTERFACES THROUGH ONE 8 BIT INPUT PORT AND ONE 8 BIT OUTPUT PORT. 16 WIRES - NO SPECIAL HANDSHAKE LINES.
- ALL SOFTWARE IS PROVIDED - YOU WRITE NOTHING!
- SIMPLE CONFIGURATION TO YOUR COMPUTER USING DDT.
- DESIGNED WITH LOW COST EASY TO GET PARTS
- OPERATES WITH ANY COMPUTER THAT RUNS CP/M AND HAS A PARALLEL PORT.

Now you can afford to build that EPROM programmer you've always wanted.

BARE P.C. BOARD WITH COMPLETE DOCUMENTATION AND SOFTWARE ON AN 8" SINGLE DENSITY DISKETTE - \$75.00
 EVALUATION DISKETTE WITH PARTS LIST - \$25.00
 BARE P.C. BOARD ONLY WITH DOCUMENTATION - \$50.00

TO ORDER SEND CHECK OR MONEY ORDER TO:

Add \$3.00 for C.O.D.
 Ohio res add 5.5% tax.

AndraTech
 1235 VILLAGE GLEN
 BATAVIA, OHIO 45103

*CP/M is a trademark of Digital Research.

Circle 386 on Reader Service card.

SCIENTIFIC SOFTWARE **\$25 and up**

SOFTWARE UNDER CP/M[®] FOR SOLVING PROBLEMS IN

- CHEMICAL KINETICS
- SEMIEMPIRICAL MOLECULAR QUANTUM MECHANICS
- GROUP THEORY
- SPECIAL FUNCTIONS

SUITABLE FOR THE MOST ADVANCED APPLICATIONS. ESTIMATES FOR CUSTOM PRODUCTS AVAILABLE.

For descriptions and prices, write or call
(402)435-6823 (after 6:00 p.m.)

SCIENTIFIC SOFTWARE
 232 W. Lakeshore Dr.
 Lincoln, Nebraska, 68528

*CP/M[®] is a trademark of Digital Research.

Circle 172 on Reader Service card.

MEMOREX FLEXIBLE DISCS

WE WILL NOT BE UNDER-SOLD!! Call Free **(800)235-4137** for prices and information. Dealer inquiries invited and C.O.D.'s accepted.



PACIFIC EXCHANGES
 100 Foothill Blvd.
 San Luis Obispo, CA 93401. In Cal. call (800)592-5935 or (805)543-1037



The Vector 8/16-bit microcomputer allows present and future software compatibility. The new Vector 4 offers a choice of several popular operating systems, and calls on 16-bit commands to significantly speed up selected eight-bit operations. Vector 4 is a product of Vector Graphic, Inc., Thousand Oaks, CA.

every 5¼-inch soft-sectored byte-oriented disk with a density under 200K. That includes the disks for a lot of systems, but it still doesn't come close to covering them all.

The second way to meet the problem of disk portability is through data communications. The RS-232C serial data communications port is still the most standardized mass input and output channel available. Data can be transferred and captured in any format, density and medium. The more different kinds of disks we get, the more we need to communicate.

8/16 Bit CPUs

Everybody is getting ready for 16 bits, but some manufacturers wisely don't want to leave the eight-bit software behind. The new Sony SMC-70, shown in the photos, features a Z-80A CPU. But the system can, in Sony's words, be "supercharged" with an optional 8086 16-bit processor.

A very impressive machine from Digital Equipment Corporation is called the Rainbow 100. It comes standard with both a Z-80 and an 8088 processor in a dual CPU configuration. This dual processor can run the CP/M-80 (eight-bit), MS DOS (directly related to PC DOS) and CP/M-86 (16-bit) operating systems. The unique single-spindle, but two-slotted drives can stuff 800K bytes onto two disks. The Rainbow 100 has a color video option. Fully configured, it has more disk storage, and a lower price, than the IBM PC.

Similarly, North Star displayed a version of their Advantage microcomputer which also combines the Z-80 and 8088 microprocessors. Not many details were available, but I was assured it could read IBM PC disks and use both eight- and 16-bit operating systems.

Many other interesting and innovative systems were shown at NCC. The pace of the growth and change in the area of microcomputers continues to increase. I'll try to keep up. ■

Circle 132 on Reader Service card.

'68' MICRO JOURNAL™
 6800-6809-68000

★ The only ALL 68XX Computer Magazine

USA
 1 YR.—\$24.50 2 Yr.—\$42.50 3 Yr.—\$64.50
 *Foreign Surface Add \$12 Yr. to USA Price
 Foreign Air Mail Add \$35 Yr. to USA Price
 *Canada & Mexico Add \$5.50 Yr. to USA Price

OK, PLEASE ENTER MY SUBSCRIPTION
 Bill my: M/C — VISA

Card # _____
 Expiration Date _____
 For 1-Yr. 2 Yrs. 3 Yrs.
 Enclosed: \$ _____
 Name _____
 Street _____
 City _____
 State _____ Zip _____

68 Micro Journal
5900 Cassandra Smith Rd.
Hixson, TN 37343

Circle 346 on Reader Service card.

DATA COMMUNICATIONS

Specialists for
IBM PC & SEATTLE
COMPUTERS

Teleprocessing software available for above computers to time-sharing hosts or between two users (send binary files, also). Version 2 software, \$60; Version 3, \$160. Write for details or \$3.00 for manuals.

SEATTLE computer hardware and Microsoft MS-DOS*, Pascal, BASIC, FORTRAN, COBOL. SPECIAL PRICE for SEATTLE SYSTEM 2 + 4-port serial board + cables + choice of Microsoft BASIC (both interpreter & compiler), Pascal, or FORTRAN. Write or call for quote.

MITS disk owners, don't throw away your drives. Try out the 8086 world with SEATTLE 8086 CPU board set. Special offer of \$750 for two-board CPU set + MS-DOS* + Microsoft MACRO-86 and utilities. (Mits I/O drivers included and ready to boot). Write for spec sheet.

CSCS COMPUTER & STATISTICAL
CONSULTING SERVICES
P.O. BOX 5351
TERRE HAUTE, IN 47805
(812) 466-4111

*TRADEMARK OF MICROSOFT, INC.

Circle 216 on Reader Service card.

H89/Z89 USER

The M89 is an I/O expansion box for the H89/Z89 computer, please call or write us for more details.

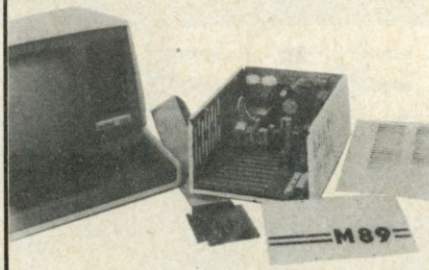

Microflash Co.
4916 B Carol St.
Skokie, Ill. 60077
(312)677-4928

Circle 90 on Reader Service card.

COMPUCOVER®

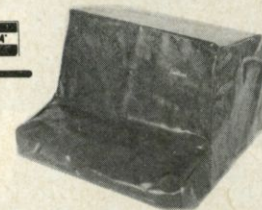

COVER YOUR INVESTMENT

- Cloth Backed Vinyl
- Anti-Static
- Custom Fitted
- Two Colors

OVER 300 DESIGNS
FROM ADES TO XYMEC

1-800-874-6391

ORDER LINE

Dealer Inquiries Invited

CompuCover
P.O. Box 324 Dept. A
Mary Esther, FL 32569

Customer
Service
(904) 243-5793

CALL TOLL FREE

Circle 252 on Reader Service card.

VOLTAGE SURGE & TRANSIENT SUPPRESSOR



Protects
Most
Electronic
Equipment

The SUPPRESSOR electronically removes or reduces sudden voltage changes. It simply plugs into a power receptacle on the same circuit as the equipment being protected.

END POWER LINE SPIKES, SURGES, HASH... Only \$29.95 ea. Dealer Inquiries Invited.



CUESTA SYSTEMS, INC.
3440 Roberto Court
San Luis Obispo, California 93401
(805) 541-4160

Circle 102 on Reader Service card.

Call Us Last For The Best Price

1-800-762-6661

RAND'S

2185 E. FRY BLVD.

and

101 W. FRY BLVD.

SIERRA VISTA, AZ 85635

Circle 158 on Reader Service card.

VOICE SYNTHESIZER WITH INTERACTIVE TELEPHONE INTERFACE

For APPLE II™ compatible dial-up voice response and remote data-base access arrangements, consider a V100 series design from VYNET CORPORATION.

- Direct connect, auto-dial/answer
- Control via Touch-Tone™ detection
- Allophone (LPC) based voice synthesizer
- Includes 1,000 word vocabulary
- Editor for custom vocabulary
- Extensive application software
- Programmable buffered port
- Upgrade available for high quality LPC vocabulary
- \$395.00

Telephone interface may be purchased without synthesizer. TRS-80™ and IBM versions available soon.

VYNET CORPORATION
2405 QUME DRIVE
SAN JOSE, CA 95131
(408) 942-1037

Circle 79 on Reader Service card.

AUTHORIZED TRS 80® DEALER #R491

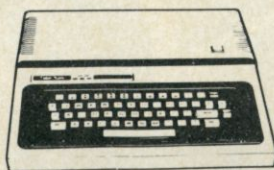

TRS-80® Color Computer With
Extended Color BASIC



26 - 1062
Model III 16K RAM
Model III, BASIC

\$815.00

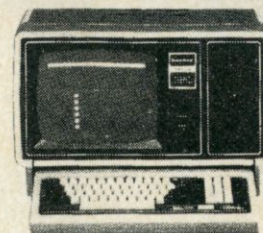

26 - 4002
Model II, 64K

WE ACCEPT CHECK, MONEY ORDER, OR PHONE ORDERS WITH VISA OR MASTERCARD. SHIPPING COSTS WILL BE ADDED TO CHARGE ORDERS. DISK DRIVES, PRINTERS, PERIPHERALS, AND SOFTWARE - YOU NAME IT, WE'VE GOT IT. WRITE OR CALL FOR OUR COMPLETE PRICE LIST.

C & S ELECTRONICS, LTD. 32 EAST MAIN ST. MILAN, MICH. 48160

(313) 439-1508 (313) 439-1400

C & S ELECTRONICS MART IS AN AUTHORIZED TRS 80® SALES CENTER STORE #R491

STAR.

WE'RE MAKING A

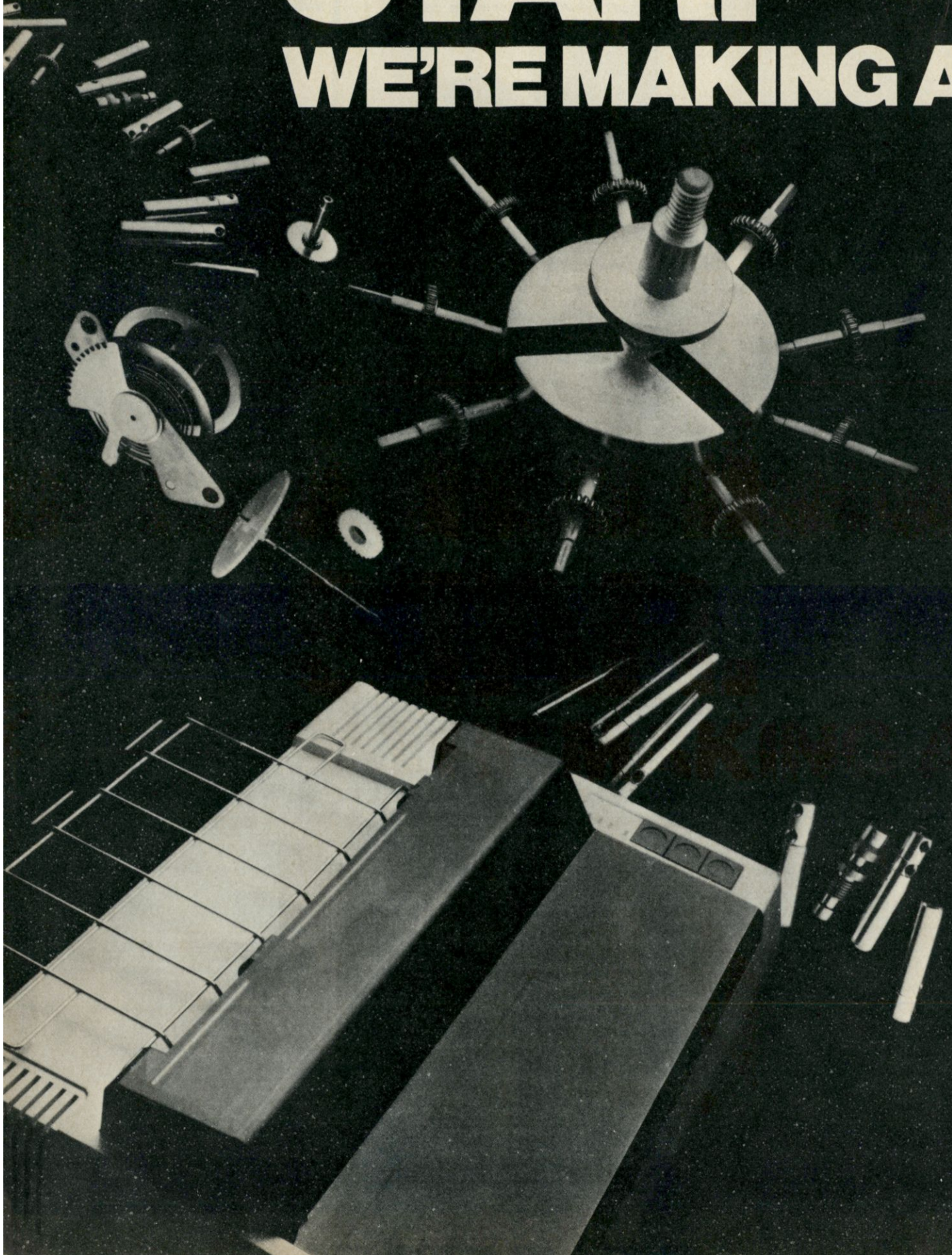

NAME FOR OURSELVES.

Building a reputation for quality printers of astronomical value, from components on up.

Making a name for ourselves in printers is only natural when we've been making the highest quality precision parts for over 30 years. And although Star's reputation in microperipherals has only begun to grow, the watch and camera industries worldwide

have been relying on Star components for nearly 3 decades.

Quality manufacturing is what we're building our reputation on. Star is a true manufacturer, not merely an assembler. We even design and manufacture the computer controlled machines that make our parts. With unlimited production capabilities, Star's factories can operate 365 days a year, 24 hours a day, producing more than 100 million parts a month. It is this kind of productivity and total quality control that assures you of get-

ting the very finest printer for the very lowest price.

And the best product for less is what you can depend on getting from Star. Star offers you a full line of reliable printers, printers with divergent technologies to meet your specific needs. And there's more. You get a low cost, high quality printer with a wide spectrum of interfaces to choose from—backed by Star's superior service network, there if you need it.

Star. We're going to be the quality printer you can count on, from components on up. And that's no pie in the sky promise.

star
MICRONICS • INC

MAKING A NAME FOR OURSELVES

200 PARK AVENUE, NY, NY 10166

Circle 361 on Reader Service card.

Atari in Wonderland

*Double the RAM
in your Atari 400,
and slip through
the looking glass
with Alice.*

By Dietmar May



Atari was beginning to get very tired of sitting by her monitor on the table, and of having nothing to do; once or twice she peeped at the TV screen, but it had only pictures on it, "and what's the use of a monitor," thought Atari, "without programs or graphics?"

So, she was considering in her own MPU (as well as she could, for the blackboard mode made her feel very sleepy and stupid) whether the pleasure of making a program chain would be worth the trouble of turning on the 410 and loading a program, when suddenly a white rabbit with digital eyes ran close by her.

There was nothing so very remarkable in that, nor did Atari think it so very much out of the way to hear the Rabbit say to itself, "Oh dear! Oh dear! I shall be \$28!" (When she thought it over it occurred to her she ought to have wondered at this, but at the time it all seemed quite natural.) But when the Rabbit actually took a real-time clock out of its waistcoat pocket, and looked at it, and then hurried on, Atari started to a SysRes, for it flashed across her MPU that she had never before seen a rabbit with a real-time clock or a waistcoat pocket to take it out of. And, rushing into Basic, she ran across initialization after it, and was just in time to see it pop down a large program under

the hedge.

In another moment, down went Atari after it, never once considering how in the world she was to get out again.

The program went straight on like a tunnel for some way, then gosubed suddenly down, so suddenly that Atari had not a moment to process a stop before she found herself falling down what seemed to be a very large subroutine.

Either the subroutine was very long, or she fell very slowly, for she had plenty of time as she went down to peek about her and to wonder what was going to happen next. First she tried to peek down and make out what she was coming to, but it was too dark to see anything; then she peeked at the elements of the memory, and saw they were arrays and strings; here and there she saw memory maps and graphics. She took down a var from one of the elements as she went past; it was labeled "orange marmalade," but to her great disappointment it was empty. She didn't want to drop the var for fear of destroying another beneath, so she put it to the S: as she fell past.

Down, down down. Would the fall never come to an end? "I wonder how many instructions I've fallen by?" she beeped aloud. "I must be getting

somewhere near the end of my memor..." CRASH!! And there the program stopped with an ERROR 2 IN LINE 574. Poor Atari could never see Wonderland with only 8K bytes of memory.

I have an Atari 400 and have spent many enjoyable hours programming it—especially learning about the graphics. It is a well-designed machine, and, for the money, I'm really glad I didn't buy another (incomparable) machine.

All of the 400 units produced after March 1981 have been shipped with 16K boards. However, many were produced before that date with only 8K of RAM, severely limiting the programming you can do on them. Atari recognized this and provides a factory upgrade that consists of replacement of the 8K board with a 16K board. This upgrade costs \$100. And as this is a little too high for many budgets (after all you bought a 400 instead of an 800), there are surely many of you who are still trying to get by on only 8K. This article describes an inexpensive (\$30 or less) upgrade in which the 8K board is modified into a 16K board.

Address correspondence to Dietmar C. May, 9704 Williamsburg Court, Upper Marlboro, MD 20772.

The memory board is 3 by 6 inches, and has a standard 44-pin edge connector with .156 inch spacing. The signals on this connector are shown in Table 1. Although the address lines appear to be scrambled, notice that multiplexed signals are next to each other; that is, the 4108/4116 memory chips have only seven address pins, and yet use 14 address lines to decode 16K. This apparent discrepancy is handled by multiplexing: by connecting first the seven lowest address lines to the memory chip and strobing an internal latch, and then the next seven address lines. Those addresses which are multiplexed are, for the most part, next to each other on the edge connector. This was undoubtedly done to simplify PC board layout.

R/W Early is used to disable read buffers during a write operation. (See Fig. 4.) Ref also disables the read buffers during a refresh cycle while the ANTIC chip does a pseudo-read (strokes the row address latch RAS while addressing the memory properly). S0-S3 are chip select signals which decode on 8K boundaries. This means that 32K bytes are decodable on the memory board. Companies that offer 32K boards use all these signals to decode the memory; the 16K board uses the first two, while the 8K board uses only S0.

The 4108s and the 5298s used by Atari are 8K by one-bit memory chips—eight chips are required for 8K bytes of memory. Actually, they are 16K by one-bit rejects sold by the IC manufacturer, in which the lower half of memory tested good, but the upper half had errors, or vice versa. Rather than throwing these away, they're sold by the manufacturer as 8K chips with the stipulation that one address bit (usually A13) is always held low or high. The resistor-jumper network found in the center of the board is used to select which line is held high or low (the 4108s and 5298s have different bad memory pins—see Table 2).

If you have 4108-x0s, you may wish to try this: perform the modifications as listed below, but instead of replacing the 4108s, reuse them. Depending on where the defective bits are located, you may gain 1, 2 or even 4K bytes of RAM. Run the following program to locate the beginning of the defective RAM region:

```

10 FOR Z = 1 TO 4: READ D
20 FOR X = 8192 TO PEEK(742)*256 +
  PEEK(741):POKE X,D: IF PEEK(X)
  < >D THEN? X,D
30 NEXT X:NEXT D:DATA 0,95,165,255:
  REM DATA IS $0,$5A,$A5,$FF TESTS
  ALL BITS

```

This will give a list of all defective

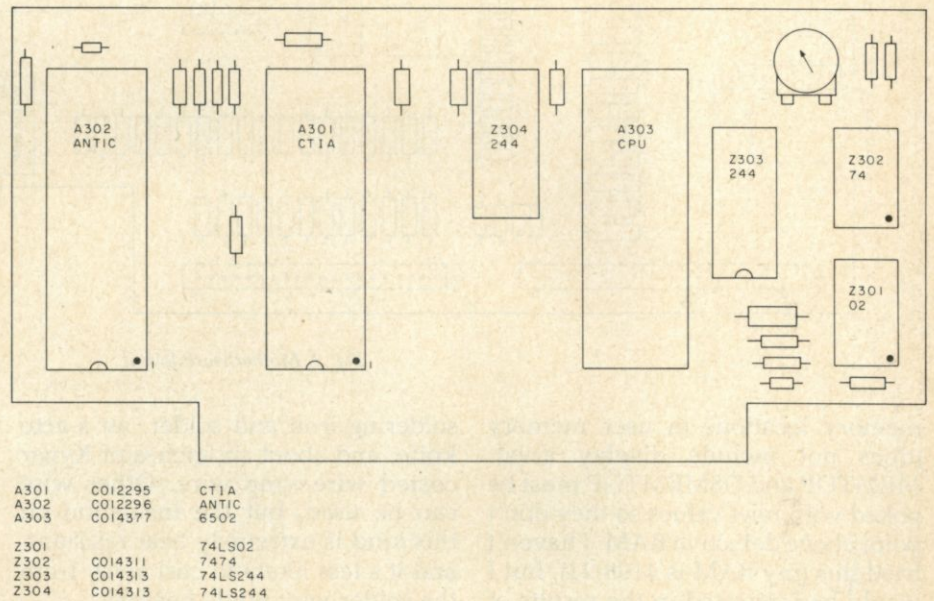

Fig. 1. Atari 400 CPU board layout.

1	D0	A	D1
2	D2	B	D4
3	D3	C	D5
4	D7	D	D6
5	A0	E	A2
6	A7	F	A9
7	A1	H	A13
8	A8	J	A4
9	A5	K	A11
10	A3	L	A12
11	A10	M	*
12	A6	N	*
13	R/W Late	P	*(S3 - 400)
14	Ø2	R	*
15	RASTime	S	*(S2 - 400)
16	R/W Early	T	*
17	REF	U	SEL1
18	SEL0	V	
19	Vcc	W	Vcc
20	Vbb	X	Vbb
21	Vdd	Y	Vdd
22	Vss	Z	Vss

*Note: the 800 uses these pins to shunt the S2-S5 lines between memory boards; this indicates to each board how much memory the previous board has.

Table 1. Memory board edge connector pinouts.

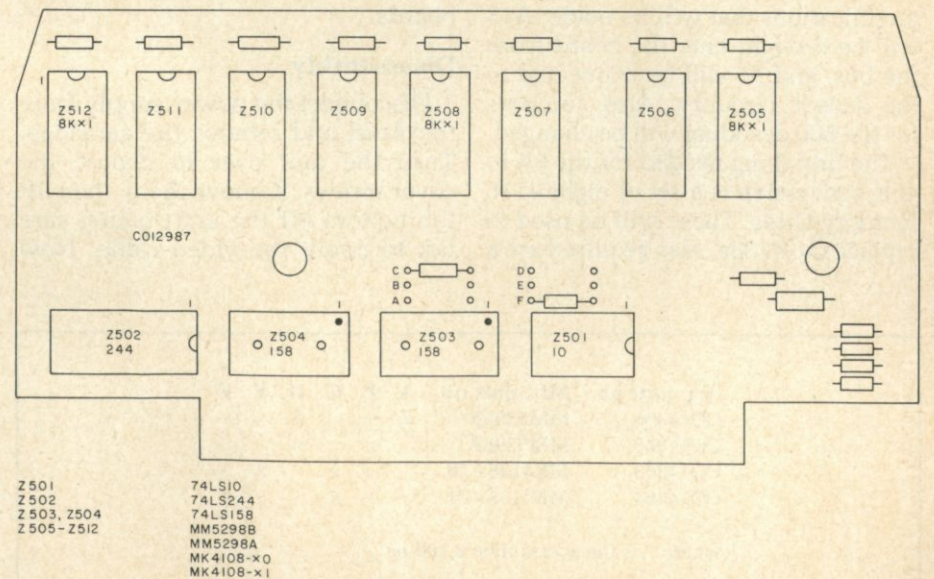

Fig. 2. Memory board layout.

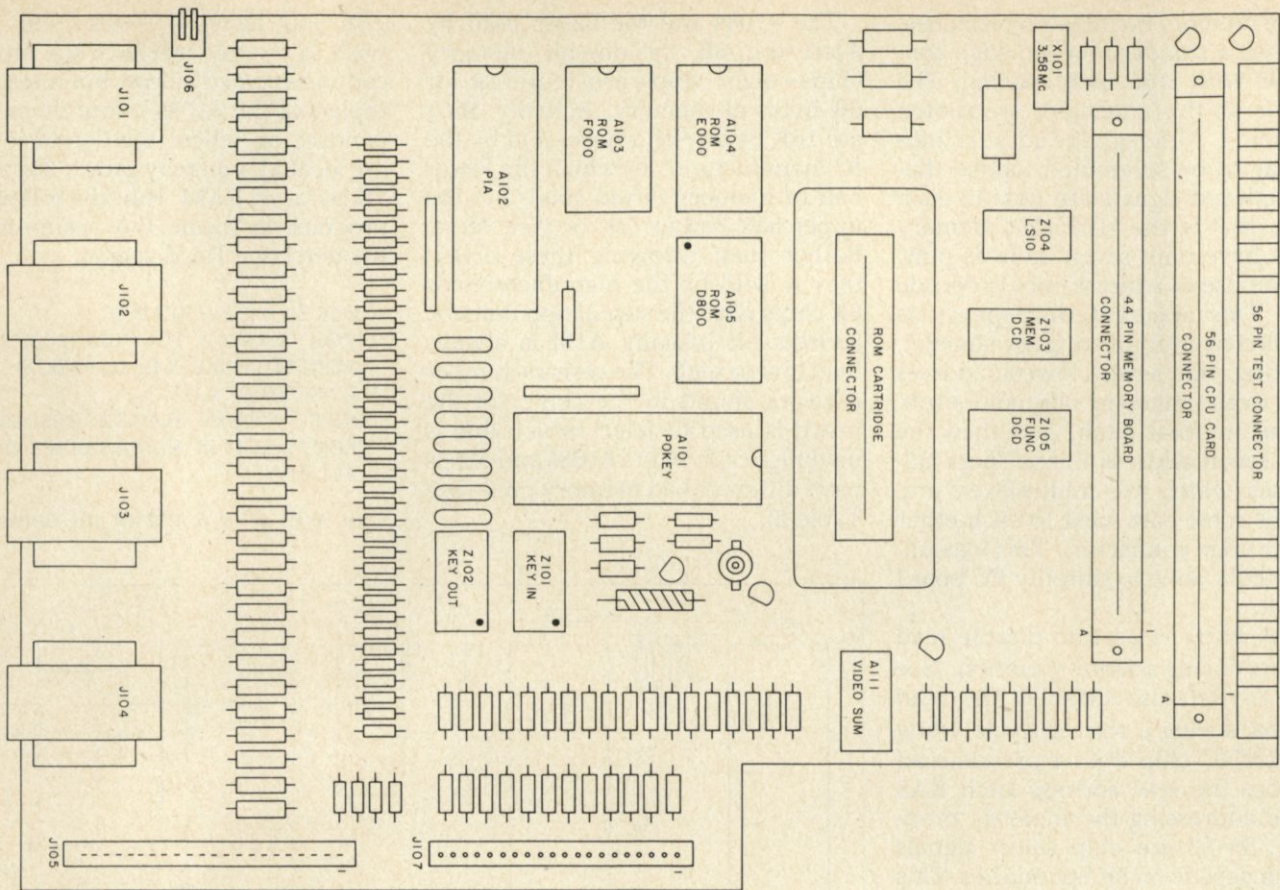

Fig. 3. Motherboard layout.

memory locations in user memory (does not include display area). MEMTOP and OSMEMTOP must be poked with new values so they don't point above defective RAM. I haven't tried this (my RAM is 4108-21), but I would be interested in the results of anyone who does try.

Modification Description

There are only two main functional modifications that will be made: A13 will be brought onto the board from the bus, and S1 will be connected to the decode circuitry. Also, jumpers for the 800 decoding will be changed.

The first thing needed for the 8K to 16K conversion is a set of eight 4116 memory chips. These will be used to replace the 4108s. Also required are a

soldering iron and solder, an x-acto knife, and about six inches of Kynar coated wire-wrap wire. Other wire can be used, but the insulation on this kind is extremely heat resistant, and it's less likely to curl away from the solder joint while heating.

WARNING: This modification will void your warranty: don't proceed unless it has expired. Also note that Atari is unable to repair modified boards.

Disassembly

Disconnect the power supply from the Atari and remove the cartridge. Turn the unit over to expose the cover screws. Remove them, then lift the bottom off the unit, taking care not to strain the video cable. Now

remove the eight screws holding the aluminum plate to the circuit board. Lift the plate and the cardboard insert.

Two connectors are located in the lower left corner of the motherboard.

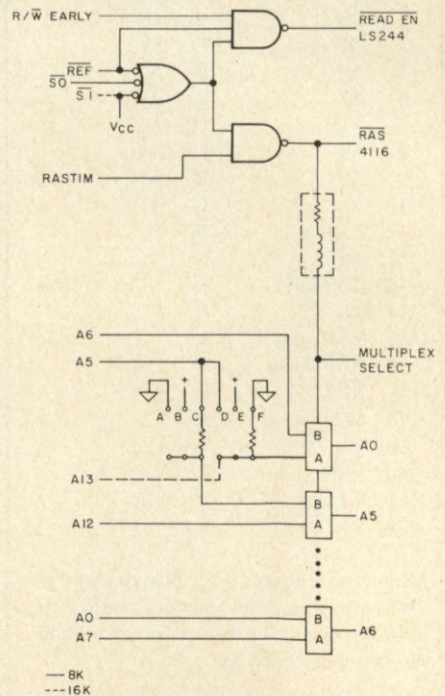

Fig. 4. Decode circuitry.

Ata. part no.	Mfr. part no.	A	B	C	D	E	F
CO14366	MM5298B	x			x		
CO14365	MM5298A		x		x		
CO14363	MK4108 - *0			x		x	
CO14364	MK4108 - *1		x				x

where * is the access time x 100 ns

Table 2. Resistor jumper truth table.

Circle 131 on Reader Service card.

Model 953A EPROM PROGRAMMER

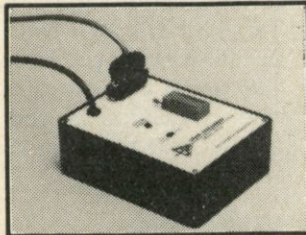

- Programs 2508, 2758, 2516, 2716, 2532 and 2732 five volt EPROMS.
- Complete - no personality modules to buy.
- Intelligent - microprocessor based, programs and verifies any or all bytes.
- RS-232 serial interface - use with computer or terminal.
- Verify erasure command - verifies that EPROM is erased.
- Extended diagnostics - error output distinguishes between a bad EPROM and one which needs erasing.
- May be used for extremely reliable data or program storage.
- All power on programming socket under processor control. LED warning light indicates when power is applied.
- Complete with Textool zero insertion force socket.
- High performance/cost ratio.
- Standard DB-25 I/O connector.

PRICE \$289



BAY TECHNICAL ASSOCIATES, inc.

HWY. 603, P.O. BOX 387
BAY ST. LOUIS, MISSISSIPPI 39520
(601) 467-8231

Circle 318 on Reader Service card.



CAN'T MAKE ENDS MEET?

We couldn't either. At least, not until 1978 when we began connecting RS-232 devices to IEEE-488 computers with our family of serial interfaces. Three units available for use with Commodore's PET/CBM, the HP-85, Osborne-1 and others, plus our IEEE-488 auto-answer/auto-dial 103 Modem and data communications software. Each interface complete with cabinet, one-year warranty, documentation. Priced from \$129-389. Details from George Masters:



Dept. KM, 3444 Hancock St., San Diego, CA 92110
(714) 296-2115 • TWX 910-335-1194
VISA/MasterCard • Dealer Inquiries Welcome

Circle 356 on Reader Service card.

Get better looking with your IBM.

Introducing the PC Pedestal™ from Curtis Manufacturing

Now you can get a real good look at your IBM Personal Computer.

With Curtis Manufacturing's new PC Pedestal™ you can tilt or swivel the IBM display unit to suit yourself.

No more bobbing and weaving to avoid reflections. No more squinting to minimize glare.

The PC Pedestal™ virtually eliminates backache, eye strain, and fatigue. And that results in greater comfort and increased productivity all around.

Developed exclusively for the IBM Monochrome Display,

the PC Pedestal™ is a perfect match in style, color & finish.

Best of all, when you see how little it costs to gain these benefits, you're going to be looking better already.

Extension Cables, too.

For even greater flexibility in arranging your system components, a 3-foot extension cable set is also available for your IBM display unit.

Manufacturing Company, Inc.

CURTIS

For credit card orders call: 1-800-824-7888
in California
1-800-852-7777
in Alaska & Hawaii
1-800-824-7919

ASK FOR OPERATOR 157



	PRICE	QTY.	AMOUNT
PC PEDESTAL™	\$79.95		
EXTENSION CABLES	49.95		
postage per item	3.00		
MC-3		TOTAL	

NAME _____
COMPANY _____
ADDRESS _____
CITY _____ STATE _____ ZIP _____

MAIL TO:
Curtis Manufacturing Co., Inc.
One Curtis Road, Winchester, NH 03470

check money order Master Card VISA send additional information
account # _____ Master Card Interbank # _____
SIGNATURE _____ expiration date ____/____/____
month year

One is for the keyboard and has a ribbon cable plugged in; the other is for the power supply/modulator board. Take care when removing this second connector: hold down the power supply board with your left hand and lift up gently on the motherboard with your other hand. Once the two boards separate, the motherboard can be lifted straight up out of its shielded enclosure.

It is best to remove the complete unit from the plastic, then remove the power supply board from the casting and the mainboard. When reassembling, be certain that the RAM and CPU cards fit properly into the plastic retainer located inside the casting.

Inspection

While the guts of your machine are out and visible, you may wish to learn more about each part's function. The card at the end of the motherboard is the CPU card. (See Fig. 1.) This contains the 6502 processor, the ANTIC chip, the CTIA, timing circuitry, and two 74LS244s to disconnect the MPU from the address bus during screen and memory refresh. See Table 3 for functions of the ANTIC and CTIA chips.

The other card is the memory board (see Fig. 2). The eight ICs at the top are the dynamic RAMs. The 74LS244 disables data-out during refresh. The 74LS158s are the address

bus multiplexers, and the 74LS10 performs decode functions.

The motherboard contains the OS ROMs, the POKEY, PIA, memory decoding, clock generator and other miscellaneous circuitry. (See Fig. 3, Table 3.) The ROMs are decoded for \$D800-\$FFFF; the POKEY, PIA, ANTIC and CTIA are at \$D000-D3FF. The connector at the rear of the motherboard provides test points for ease of servicing.

Modifications

Remove the memory card from the motherboard and place it on the aluminum shielding plate, which will short out the pins and provide a grounding plane.

Remove all the ICs by inserting a narrow flat-bladed screwdriver under one side and alternately prying up and pushing under the chips. Use care to avoid bending any of the pins, especially when one side is almost out of the socket. The ICs should be pried out parallel to the circuit board. If necessary, pry up on one side slightly, then on the other. Remove the 4108 chips first, then the four TTL ICs. Handle them by the ends, not by the leads. Place them with their pins down onto the aluminum shielding plate.

- Next, cut the trace between pins 13 and 14 of Z501.

- Also cut the trace between pins T and U on the edge connector.

- Solder a jumper between pin U connector and pin 13, Z501. This connects S1 (second 8K decode) to the RAM enable circuitry.

- Remove the resistor at D, E or F.

- Also be sure that C is jumped, not A or B, which ensures that A5 goes to the RAM as A5. Take some masking tape and cover the lower half of pin H connectors.

- Solder a wire from H connectors to the common side of D,E,F. The tape will prevent solder from building up at the bottom of the connector pin. This connection brings A13 onto the board.

If you have a 400, you're done with the mods, and can replace the ICs starting with the TTL and ending with the 4116s. Be sure that pin 1 on the IC matches the pin 1 silkscreened on the board (pin 1 should be indicated by a notch at the top or a dot in the upper left corner of the chip). The TTL ICs should be in upside down, and the 4116s should have the notch at the top of the card.

When installing the new 4116s, note

Chip name	Function
ANTIC	DMA (direct memory access) control NMI (non maskable interrupt) control Vertical and horizontal fine scrolling Vertical line counter WSYNC (wait for horizontal sync) Light Pen position registers
CTIA	Priority control (display of overlapping objects) Color-Luminance control (transferred from ANTIC) Player-Missile objects (four players, four missiles) Graphics registers Size control Horizontal position control Collision detection between objects Joystick trigger sensing
PIA	Joystick jacks read or write Peripheral control and interrupt lines IRQ (maskable interrupt request) control from peripherals
POKEY	Keyboard scan and control Bidirectional serial port POT scan (paddles) Audio generators (four channels) Timers Random number generator

Table 3. Special chip functions.

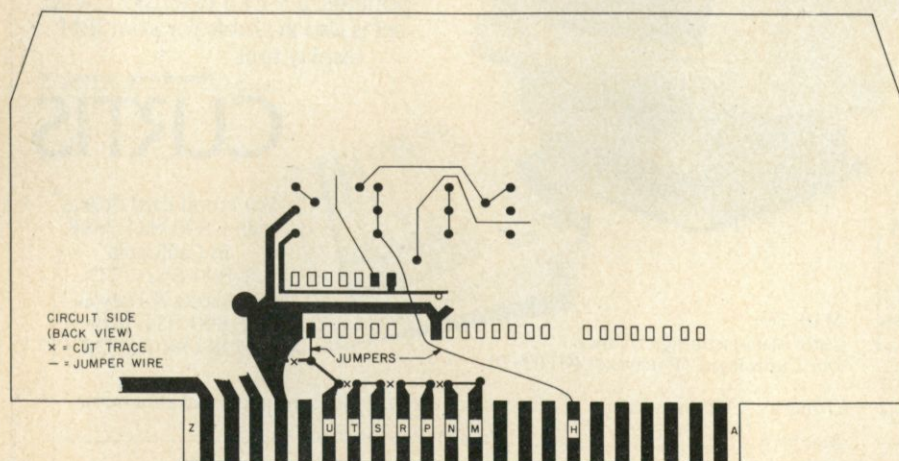

Fig. 5. Memory board mods.

VOLUME 2
now available!

NIBBLE EXPRESS

TABLE OF CONTENTS

CHAMP
 Working Out with CHAMP
 Amper-Reader
 Hex/Dec Codes Without Conversio
 Auto Run and Tape Protection
 MRS
 Le Mans
 Inputting Strings With Commas
 Phantom Numeric Pad
 Disk Snooping Part 1
 Apple Paintbox
 Mad Mad Cube
 Disk Snooping Part 2
 Applsoft Linefinder
 Direct Keyboard Disk Commands
 Converting Muffin to Demuffin
 Apple STAR System
 Disk Snooping part 3
 Intesoft Connection part 1
 Trap 'Em
 Fast Data Format
 Quick and Easy Hi-Res
 Apple RAT
 Binary Disk Copy
 Disk Master
 Trap/Step
 Biorhythms
 Intesoft Connection part 2
 Teleprocessing
 Lo-Res Screen Dump
 Apple Tricks Reset Trap
 Mini-Amper Edit
 How to Enter Assembler Listings
 Free Cat for Apple DOS Users
 M.A.P.S.
 Amper Jump & TSort
 Apple Artist
 Pascal Lo-Res Graphics
 Big CAT
 Amper Store Recall
 D.A.R.T.
 Print Use
 Intesoft connection III
 Lazer Blaster
 Auto Repeat Key
 Poor Boy's LE
 Catsup—Catalog Supervisor
 TRAC Budget
 TRAC Graphics
 TRAC Plus
 Archives
 Intesoft connection IV
 Command Changer • (missing the
 DOS Remover

NIBBLE EXPRESS VOLUME 2 NOW AVAILABLE!

The 1981 Anthology of the major articles and programs is underway! It contains up-to-date enhancements and corrections to programs which appeared in Volume 2 of NIBBLE.

Even if you have all 8 issues of NIBBLE in 1981, you'll want The Express to have updated program listings in one convenient package!

200 solidly packed pages with major programs and articles for your Apple! A MUST for your Library!

NIBBLE EXPRESS will be an invaluable reference for your Apple now and for years to come!

for only \$14.95 (plus shipping) you can make Nibble Express a permanent part of your library.

ORDER YOUR COPY NOW!

NIBBLE

P.O. Box 325
 Lincoln, MA 01773

Yes! I want NIBBLE EXPRESS Vol. 2 in my library!
 Here's my Check Money order
 for \$14.95 plus \$1.75 postage/handling. (Outside
 U.S. add \$2.75 for postage/handling).

Also send me NIBBLE EXPRESS Vol. 1 at \$12.95
 plus \$1.75 postage/handling (outside U.S. add \$2.75
 for postage/handling).

Master Card & Visa Accepted

Card # _____ Expires _____
 Telephone _____
 Name _____
 Street _____
 City _____ State _____ Zip _____

Your check or money order must accompany your order to qualify.
 Outside U.S.: Checks must be drawn on a U.S. Bank.
 *Apple is a registered trademark of Apple Computer Company.

5
 8
 10
 11
 12
 14
 17
 19
 21
 22
 25
 28
 30
 34
 37
 39
 42
 48
 52
 57
 60
 62
 63
 65
 67
 76
 82
 88
 93
 97
 100
 103
 106
 108
 112
 118
 123
 127
 131
 132
 134
 142
 148
 152
 153
 154
 155
 157
 159
 162
 165
 168
 171
 176

that their pins are spread apart further than the socket, so insertion will be a little tricky. Try either inserting one side part way first, then pushing on the other side slightly; or bend the pins in some, preferably with a pair of needle-nose pliers or by pressing each side against a flat surface (e.g., a table top).

If, however, you have an 800, you have several other modifications to make. Cut the traces between edge connector pairs R and S, and N and P. Now jumper these pairs: S and T, P and R, M and N. These are used in the 800 to indicate to other memory slots the size of each board. This is done by shunting the S0-S5 decode lines around onto different pins. Now the boards are completely modified and can be installed after the ICs are replaced.

Installation

Before installing the board, run a finger along both sides of the edge connector to redistribute the anticorrosion paste. Plug the board in backwards, with the chips facing the CPU card (which should face towards the test connector). Plug the keyboard ribbon cable back in if it was re-

moved (this can be a real hassle, so have patience).

Now place the motherboard back over the shielding, and let the plug-in cards drop down. Align the pins of the power supply/motherboard connector and push down firmly. Replace the cardboard insert, and after making sure there's no conductive paste on it, replace the aluminum plate. After fastening this, the bottom can be replaced.

I've found that it's easier to assemble the unit right-side up. To do this, the molded plastic top must be removed. It's held on by two means: the cartridge access door, and a small plastic clip which fits under the front of the keyboard. Open the cartridge door; now pull gently on the front center of the 400 where the joystick jacks are. A small tab should pop out and over the keyboard. The top can then be worked over the cartridge door.

Put the bottom piece on a flat surface. Run the video cable along the slots in the base. Next, take the guts and place them into the base, centering them between the small tabs sticking up. You may find the assembly isn't resting level in the back: lift

the back up slightly and pull the video cable up off the base so that it can clear through the notch in the shielding.

Take care not to damage the speaker when replacing it—it's easy to do. Make sure the keyboard and motherboard assembly are all level, replace the top, and tighten the screws down.

Now for the final check. Plug in the power cord, insert Basic, and type in PRINT FRE(0). Your computer should respond with 13326 bytes free. If you still have only 5192 bytes free, check the first three steps in the modification, which connect S1 to the decode circuitry. If you got 13K free, then poke around 8150 and check the screen for garbage; if you do get characters to appear on the screen this way, the A13 line isn't connected properly. If nothing happens, check all of the steps in the modification. If the screen display is screwy (bad horizontal hold, garbage appears on power-up, etc.) you may have a bad RAM chip, or an IC pin may have been bent during insertion.

Now that your Atari has 16K, she (and you too) can follow the white rabbit into a programming Wonderland. ■

Circle 198 on Reader Service card.

COMPUTER KITS – FROM \$69.95

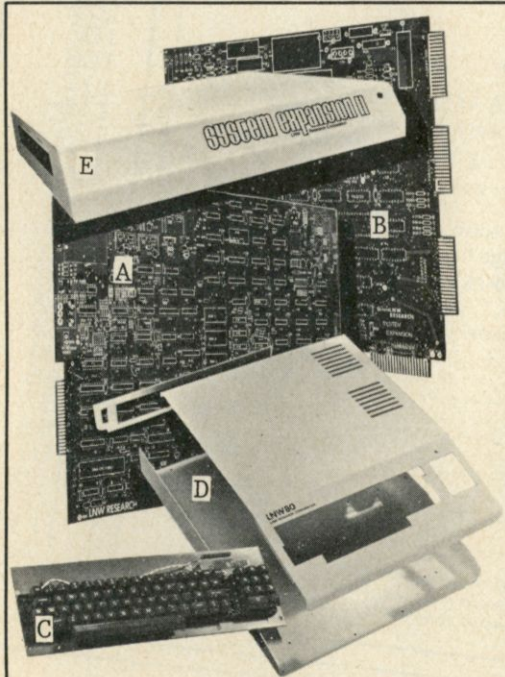

LNW SEMI-KITS can save you hundreds of dollars. By obtaining your own parts at the lowest possible cost and assembling the **LNW SEMI-KITS**, you can have the most highly acclaimed microcomputer in the industry – the **LNW80**. The **LNW SEMI-KITS** are affordable modules. You can start with a modest cassette system and expand to a full 4Mhz TRS-80 compatible system with 5 or 8 inch double density disks and color at any time.

A. LNW80 CPU – Made of high quality FR4 glass epoxy double sided circuit material, with plated-through holes and gold edge connector. It is fully solder-masked and silk screened. Here are just some of the outstanding features you will have when your **LNW80 CPU** board is fully assembled: • 16K RAM • Color and black and white video • 480 x 192 high resolution graphics • 64 and 80 column video • 4 Mhz Z80A CPU • Upper and lower case display • 500 and 1000 baud cassette I/O – **\$89.95**

B. SYSTEM EXPANSION – Expand the **LNW80** computer board, **TRS-80** and **PMC-80** computer with the following features: • 32K memory • Serial RS232C and 20Ma port • Real time clock • Parallel printer port • 5 inch single density disk controller • Expansion bus (screen printer port) • Onboard power supply • Solder-masked and silk screened legend – **\$69.95** (tin plated contacts) – **\$84.95** (gold plated contacts)

C. KEYBOARD – 74 key expanded professional keyboard – includes 12 key numeric keypad. Fully assembled and tested. – **\$99.95**

D. COMPUTER CASE – This stylish instrument-quality solid steel case and hardware kit gives your **LNW80** that professional factory-built appearance. – **\$84.95** Add \$12.00 for shipping.

E. SYSTEM EXPANSION CASE – This stylish instrument-quality solid steel case and hardware kit gives your **SYSTEM EXPANSION** interface that professional factory-built appearance. – **\$59.95** Add \$10.00 for shipping.

F. LNW80 CPU – HARD TO FIND PARTS KIT – \$82.00

G. LNW80 VIDEO – HARD TO FIND PARTS KIT – \$31.00

H. SYSTEM EXPANSION – HARD TO FIND PARTS KIT – \$27.50

I. LEVEL II ROM set. (6 chip set) – \$120.00

VISA and **MasterCard** accepted. Add \$3.00 for shipping plus \$1.00 for each additional item. All shipments via UPS surface. Add \$2.00 for U.S. Mail. Shipments outside continental U.S.: funds must be U.S. dollars. Sufficient shipping costs must be included with payment.

ORDERS & INFORMATION – (714) 544-5744
SERVICE – (714) 641-8850

LNW Research Corp.

2620 WALNUT Tustin, CA. 92680

STOP PLAYING GAMES

PET/CBM
APPLE
TRS-80 (Model I & III)
COLOR-80
VIC-20



- Calculate odds on HORSE RACES with ANY COMPUTER using **BASIC**.
- **SCIENTIFICALLY DERIVED SYSTEM** really works. TV Station WLKY of Louisville, Kentucky used this system to predict the odds of the 1980 Kentucky Derby. See the Wall Street Journal (June 6, 1980) article on Horse-Handicapping. This system was written and used by computer experts and is now being made available to home computer owners. This method is based on storing data from a large number of races on a high speed, large scale computer. 23 factors taken from the "Daily Racing Form" were then analyzed by the computer to see how they influenced race results. From these 23 factors, ten were found to be the most vital in determining winners. **NUMERICAL PROBABILITIES** of each of these 10 factors were then computed and this forms the basis of this **REVOLUTIONARY NEW PROGRAM**.
- **SIMPLE TO USE:** Obtain "Daily Racing Form" the day before the races and answer the 10 questions about each horse. Run the program and your computer will print out the odds for all horses in each race. **COMPUTER POWER** gives you the advantage!
- **YOU GET:**
 - 1) TRS-80 (Level II), Color-80, Apple or PET/CBM or VIC-20 Cassette.
 - 2) Listing of BASIC program for use with any computer.
 - 3) Instructions on how to get the needed data from the "Daily Racing Form"
 - 4) Tips on using the odds generated by the program.
 - 5) Sample form to simplify entering data for each race.

MAIL COUPON OR CALL TODAY

3G COMPANY, INC. DEPT. KB (503) 357-9889
RT. 3, BOX 28A, GASTON, OR 97119

Yes, I want to use my computer for FUN and PROFIT. Please send me _____ programs at \$24.95 each.

I need a TRS-80 Color-80 Apple PET/CBM VIC-20 Cassette.

Enclosed is: check or money order Master Charge Visa

Card No. _____ Exp. date _____
NAME _____
ADDRESS _____
CITY _____ STATE _____ ZIP _____

START USING YOUR COMPUTER FOR FUN and PROFIT!

UV EPROM ERASER



\$49.95

- ERASES ALL UV ERASABLE EPROMS (2708, 2716, 2564, etc.)
- QUICK FIFTEEN MINUTES ERASE TIME
- ERASES OVER FIFTEEN EPROMS AT A TIME
- LAMP LIFE, 7700 HOURS
- INDUSTRIAL MODEL \$68.50.
- INDUSTRIAL MODEL WITH TIMER & SAFETY INTERLOCK SWITCH \$97.50. (Rugged steel enclosure with bottom drawer)

THE BEST 6809 SINGLE BOARD COMPUTER AVAILABLE

- Floppy Controller
 - Printer Port
 - RS-232 Port
 - SWTPC compatible
 - Runs TSC Flex
 - Full Documentation
- PRICE: **\$389.00**

FOR THE SS-50 AND S-100 BUS

ASSEMBLED, TESTED, 48 HOUR BURN-IN, 90 DAY WARRANTY

2716 EPROMS 450 ns \$4.95 DIRECT FROM FACTORY

SS-50 6809 CPU CARD: 1MHZ \$149.00 2MHZ \$189.00

RS-232 INTELLIGENT EPROM PROGRAMMER . . . \$489.00

Programs: 2716, 2516, 2532, 2732, 8748, 8749

ANTISTATIC FOAM 4" x 8" \$3.95

WE ACCEPT VISA, MASTERCARD, C.O.D., CHECKS

PHONE ORDERS (305) 776-5870

TWX: 510-955-9496 • Engineering Hot-Line: (305) 974-0967

LOGICAL DEVICES INC.

781 W. OAKLAND PARK BLVD. • FT. LAUDERDALE, FLORIDA 33311

ADD: \$3.00 SHIPPING, \$2.00 C.O.D. CHARGES

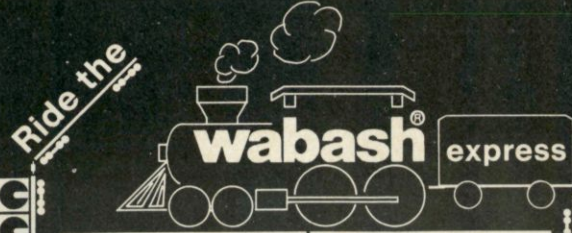

5 1/4" \$199*

SINGLE SIDE
SINGLE DENSITY
W/HUB RING
SOFT.
10 OR 16
SECTORS
100% CERTIFIED
2 YEAR WARRANTY

8" \$199*

SINGLE SIDE
SINGLE DENSITY
SOFT
OR 32
SECTORS
100% CERTIFIED
2 YEAR WARRANTY

5 1/4" \$219*

SINGLE SIDE
DOUBLE DENSITY
W/HUB RING
SOFT.
10 OR 16
SECTORS
100% CERTIFIED
2 YEAR WARRANTY

8" \$249*

SINGLE SIDE
DOUBLE DENSITY
SOFT
OR 32
SECTORS
100% CERTIFIED
2 YEAR WARRANTY

5 1/4" \$299*

DOUBLE SIDE
DOUBLE DENSITY
W/HUB RING
SOFT.
10 OR 16
SECTORS
100% CERTIFIED
2 YEAR WARRANTY

8" \$309*

DOUBLE SIDE
DOUBLE DENSITY
SOFT
OR 32
SECTORS
100% CERTIFIED
2 YEAR WARRANTY

- * Minimum order 100 • For smaller quantities add 10%
 - Packed 10 boxes of 10 diskettes with sleeves and labels
 - Quantity discounts - 1,000 deduct 3%, 5,000 deduct 5%, 10,000 deduct 7%
 - Add \$5.00 per case 5 1/4", \$7.00 per case 8"
- For shipping and handling Continental U.S.A., U.P.S. ground.

Box of 10 diskettes:	5 1/4"	8"
OPUS	ss/sd \$20	ss/sd \$21
BASF	ss/dd \$23	ss/sd \$24
MAXWELL }	TOO LOW TO QUOTE CALL	
DYSAN	SPECIFY SECTORING WHEN ORDERING	
	5 1/4" QUAD DENSITY IN STOCK	

DISK DRIVE HEAD CLEANING KITS
Prevent head crashes and ensure error-free operation
5 1/4" or 8" \$19.50

HARDHOLE DISK PROTECTORS
Reinforcing rings of tough mylar protect disk hole edge from damage.
5 1/4" 8"
Applicators \$3 \$4
Hardhole Rings (50) \$6 \$8

SFD C-10 CASSETTES . . 10/\$7
(All cassettes include box and labels)
Get 8 cassettes, C-10 Sonic, and Cassette/8 Library-Album, as illustrated, for only \$8

LIBRARY CASES
8" Kas-sette/10 \$2.99
5 1/4" Mini Kas-sette/10 \$2.49

5 1/4" or 8"
Vinyl Storage Pages 10/\$5

- Written purchase orders accepted from government agencies and well rated firms at a 10% surcharge (wabash media only) for net 30 billing.
- International orders accepted with a 15.00 surcharge for handling, plus shipping charges.
- C.O.D. requires a 10% deposit.
- We accept Visa, Mastercharge, Money Orders, and Certificate checks.
- Checks require bank clearances.
- All shipments F.O.B. San Diego.
- Minimum shipping and handling 2.00, minimum order 10.00.
- California residents all 6% sales tax.
- Prices and terms subject to change without notice.
- All sales subject to availability, acceptance, and verification.
- All sales are final.
- Satisfaction guaranteed or full refund.

We also offer printer ribbons, printwheels, type elements, equipment covers, power consoles, paper supplies, storage and filing equipment, furniture and many other accessories for word and data processing systems. Write for our free catalog.

Toll Free Order Only
800-854-1555

ABM PRODUCTS

For Information or California Orders
(714) 268-3537

8868 CLAIREMONT MESA BLVD.
SAN DIEGO, CALIFORNIA 92123

Everything You Need On a Single Board

This well-designed Z-80 computer from Colonial Data Systems Corp. is loaded with features and compares very favorably to other micros on the market.

By Terry Kepner

The SB-80 from Colonial Data Systems Corp. is one of the newest Z-80 computers on the market. It contains all the features you could want on a single board: 64K bytes of RAM memory, two parallel ports, two serial ports, single and double density floppy disk controller, clock circuit and power supply. Included in the computer's case are two Shugart eight-inch double-density disk drives.

One important aspect of the SB-80 is its 50-pin expansion connector which allows access to all data and address lines coming from the Z-80A. The obvious benefit of this is that it can easily support a host adapter interface for hard disks, expanded memory, additional serial and parallel ports, or any other hardware expansion. This gives it the capabilities of an S-100 bus machine while retaining the simplicity of a single-board computer.

The SB-80 is sold with the CP/M operating system for \$2995. It can also operate with MP/M. It is a true CP/M computer and is capable of using almost any program based on CP/M.

Accounts Receivable, Accounts Payable, Mailing List, and many other business programs are available for the SB-80 from S & M Sys-

tems, 2 Washington St., Haverhill, MA 01830.

The SB-80 is sold without a terminal (keyboard and video) allowing you to buy only what you need for the system.

System Features

The SB-80 (Colonial Data Systems Corp., 105 Sanford St., Hamden, CT 06514) is a single-board computer that uses the Z-80 CPU and operates at 4 MHz. When the system is first turned on, a built-in ROM performs a quick RAM check of the lower 16K bytes of RAM and then bootstraps the CP/M (or MP/M) disk into memory. After the ROM finishes the bootstrap, it "bank switches" itself out of the way leaving only RAM available.

RS-232. The RS-232 capability of the SB-80 is extensive. It has two completely independent, full duplex channels. Data rates can be selected from 50 to 19,200 baud. Each channel's receiver is quadruply buffered, with three eight-bit registers in a first-in-first-out arrangement and the fourth as an eight-bit input shift register. This quad buffering gives the CPU more time to service an interrupt before incoming serial data is lost because the CPU is busy elsewhere.

The transmitters are double buffered with one eight-bit output shift register and one eight-bit buffer register. Each channel has five eight-bit control registers; two eight-bit status

registers and two eight-bit sync-character registers. There are also two 16-bit shift registers used for CRC (cyclical redundancy check) generation and checking with appropriate internal feedback. The feedback can be software controlled to use either one of two different CRC codes.

The RS-232 channels operate in any one of three different modes:

- Asynchronous with five, six, seven or eight bits/chr; one, 1/2, or two stop bits; even, odd or no parity; break generation and detection; parity, overrun and framing error detection; and $\times 1$, $\times 16$, $\times 32$ and $\times 64$ clock modes.

- Binary synchronous operation with internal or external character synchronization; one or two characters; sync characters in separate registers; automatic sync character insertion; and CRC generation and checking.

- HDLC (also called IBM SDLC) operation with automatic zero insertion and deletion; automatic flag insertion; address field recognition; I-field residue handling; valid receive messages protected from overrun; and CRC generation and checking.

In addition to these functions you also have daisychain-priority-interrupt logic so that you can use automatic interrupt vectoring without having to write your own external logic to handle this problem.

The physical setup of these ports is very practical. The RS-232 ports are connected to jumper pads on the cir-

Address correspondence to Terry Kepner, PO Box 481, Peterborough, NH 03458.

cuit board, as are the connections to the DB-25 connectors at the rear of the computer's cabinet. The DB-25 pads and the RS-232 pads are connected together via jumper wires which you can easily change to any arrangement you need. This makes the task of connecting the SB-80 to non-standard RS-232 equipment simple; all you need to know are the pin connections of the hardware. How to do this is explained in the manual.

When the SB-80 is first powered up, channel A is set to 9600 baud and put in the asynchronous communication mode. Channel B is set to 300 baud.

There is one disadvantage to the setup of the RS-232 ports: there are only two pins available for the three signals T×CB, R×CB and DTRB. They are normally configured with T×CB and R×CB on the same pin because most communications will use the same clock speed and phase for both the transmit and receive modes. Because it's rare for the transmit and receive modes to operate at different speeds, I don't think that the lack of a separate pin for each of these three signals is much of a problem.

Parallel ports. There are two parallel ports in the SB-80; both are programmable and TTL compatible. The ports are eight-bit bidirectional, with handshake data control. The handshaking is driven by interrupts from the peripheral device connected to the computer.

There are four modes of operation:

- Byte output
- Byte input
- Bit control
- Byte bidirectional bus (port A only)

As with the serial ports, the parallel ports incorporate daisy-chain-priority-interrupt logic for automatic interrupt vectoring.

On the parallel ports this interrupt priority means that you can have two terminals connected simultaneously with the computer servicing each terminal only when it receives an interrupt from that terminal. This prevents it from spending half its time checking each terminal to see if there is anything waiting for it.

The port logic is divided into four sections: the control logic, the interrupt control logic, port A I/O logic and port B I/O logic. Each port's logic control is composed of six registers: an eight-bit data-input register, an eight-bit output register, a two-bit mode control register, an eight-bit



Colonial Data's single-board Z-80 computer, the SB-80.

mask register and eight-bit input/output select register and a two-bit mask control register.

The mode control register is used to select one of the four possible operation modes (byte input, byte output, byte bidirectional or bit control). Data transfer between the CPU and the peripheral is through the I/O registers. The eight-bit mask register, the eight-bit I/O select registers and the two-bit mask control register are reserved for use only in the bit-control mode. As in a security system with triggers which are either on or off, the bit mode is a very powerful method of connecting the SB-80 to other devices which generate only one condition.

The I/O register allows you to specify each individual bit in the mask register as either an input or an output bit. The mask register itself determines which bits are to be scanned. The two-bit control register lets you specify if the incoming/outgoing bit is going to be either a logical 1 or a logical 0. Therefore, if you have the SB-80 connected to an alarm system of five alarms, the SB-80 doesn't have to poll the alarms one at a time. It works on other tasks instead and only looks at the alarms when it receives an interrupt signal that tells it to scan the parallel port to see which alarm (or any number of them) has sent in a signal of activity.

Timer circuit. The on-board counter/timer is a programmable, four-channel device that provides the counting and timing functions of the SB-80. Each channel is composed of two reg-

isters, two counters and their control logic. The two registers are an eight-bit, time-constant register which initializes and re-loads the down-counter at the start. Each time the down-counter reaches 0 there is an eight-bit control register which selects the mode and conditions of the channel's operation. The counters are an eight-bit down-counter which takes the number given to it by the time-constant register and decreases it until it reaches 0, and an eight-bit pre-scaler that can be programmed to divide the 4 MHz clock rate of the computer by either 16 or 256. The pre-scaler determines the rate at which the down-counter decreases.

Expansion adapter. The 50-pin expansion adapter makes the Z-80 CPU bus available for further growth of the SB-80. It has a few nice features in addition to the buffering and availability of the Z-80 Tri-state bus. One of these features is an 8 MHz clock at the connector. This extra clock operates at twice the rate of the system clock and allows you more complex clocking circuitry in external devices than would otherwise be possible.

Another feature allows external circuitry to take control of the internal Z-80 bus if you need it. Another available feature allows you to lock out the internal memory of the SB-80 and lets the external circuitry supply the memory to be used by the SB-80. This provides a simple and effective method of "bank switching" memory into the SB-80 at the control of external circuitry.

Without having to create external

logic, you can daisychain up to four Z-80 peripheral chips into the priority interrupt structure. On-board logic assures that the highest priority device which requests an interrupt will be serviced first. If you find it necessary to add more than four Z-80 chips to the expansion adapter, you can add your own "look ahead" logic and connect up to 30 chips using standard TTL logic circuits.

The SB-80 isn't directly S-100 compatible because all the control and data lines are brought out on the expansion bus and properly buffered. However, it's an easy chore to interface the SB-80 to almost any device on the market. Although it isn't mentioned in the documentation or advertisements, one of the immediate uses of the expansion adapter is the ability to interface the SB-80 with

Corvus and Shugart hard disks giving you an option to add up to 80 megabytes of hard-disk storage capacity. In fact, according to Bob Schock, the president of Colonial Data, many of their computers are sold with hard-disk drives as a package deal.

Keyboard interface. The keyboard interface is a simple 8 x 8 switch matrix capable of being connected to a stand-alone keyboard of 62 keys. The

SYSTEM	TYPE	CPU	BITS	SPEED	OPSYS	LANGUAGE	TIME	TESTED BY:
COLONIAL DATA	SB80	Z80	8	4	CP/M2.2	MBasic5.2	661	S & M Systems
ALTOS	8002	Z80	8	4	CP/M2.2	MBasic5.2	662	S & M Systems
CA. COMPSYS	2810	Z80	8	4	CP/M2.2	MBasic5.2	663	Bob Loesch
OHIO SCI	C4-P	6502	8	2	OS65D3.2	Level I Basic	680	
CROMENCO	Z-2H	Z80	8	4	CDOS2.36	32K Basic, SFP	935	Paul Hansknecht
TANDY	TRS-80II	Z80	8	4	TRSDOS	Disk Basic	955	
APPLE	IIPLUS	6502	8	2	DOS 3.2	APLSOFTIIBasic	960	
CROMENCO	Z-2H	Z80	8	4	CDOS2.36	32K Basic, LFP	1130	Paul Hansknecht
OHIO SCI	C3-C	6502	8	1	OS65D	Level I Basic	1346	
HP	HP-85	PROP	8	N/A	N/A	Basic	1380	
BASIC/FOUR	600	8080	8	N/A	N/A	Basic	1404	
ZENITH	Z-89	Z80	8	2	CP/M2.2	MBasic5.2	1500	S & M Systems
IMSAI	I8080	8080	8	2	CP/M2.2	MBasic50	1614	
TANDY	TRS-80III	Z80	8	2	TRSDOS	Disk Basic	1695	William Gollan
EXIDY	SORC'R	Z80	8	2	CP/M1.4	MBasic50	1740	Henry Deutsch
TANDY	TRS-80I	Z80	8	2	TRSDOS	LevelIIBasic	1928	

Table 1. Benchmark test results.

PICK A SYSTEM!

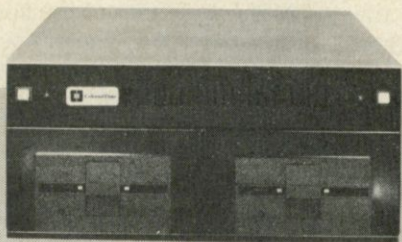

\$2495.
.5 MB STORAGE

◀ **COMPLETE** ▶

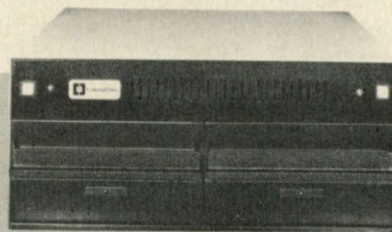

\$2995.
1.2 MB STORAGE

We're offering you our SB-80 system in either 5 1/4" or 8" disk drives, your choice. Either way your system comes with a full size (12" diagonal) non-glare tiltable green screen with 24 lines by 80 character format. Its multi-character set offers blinking cursor, underlining, reverse video, and half and zero intensity. The movable, detachable keyboard has a numeric pad with cursor control and function keys.

- Single Board Technology ■ CP/M® Operating System
- 4 MHz Z80A CPU ■ 64K 200ns Main Memory
- 8-Inch Dual Density Floppy Drives
- 5 1/4-Inch Dual Density Floppy Drives
- 2-Serial Ports ■ 2-Parallel Ports
- 4-Counter/Timers ■ Expandable

For further information about this limited offer call or write:



Colonial Data

Nationwide on-site and depot repair service through the professionals at INDESERV.

*CP/M is a registered trademark of Digital Research, Inc.

Colonial Data Services Corp., 105 Sanford Street, Hamden, Conn. 06514 • (203) 288-2524 • Telex: 956014

software, using this technique, has complete control of the keyboard including the ability to detect the depression of more than one key.

Floppy disk controller. The SB-80 uses the Western Digital FD1793 for dual-density data bus control and is compatible with the IBM 3740 and the IBM System 34.

The manual. The documentation supplied with the SB-80 is in two, two-inch thick, three-ring binders. The first binder covers the hardware and initial operation of the SB-80; the second binder covers the CP/M operating system that comes with the unit. Binder number one is roughly divided into three sections. The first section covers the main hardware features of the SB-80: first in a brief form that summarizes each feature's attributes, and then in more specific detail.

The first section is about 68 pages and includes seven fold-out pages of hardware schematics. The second section, 25 pages, is the operator's guide to using the SB-80. It tells you how to power it up, what the connectors on the back do and the functions of the lights, switches and doors on the front of the unit. It lists the procedures necessary to turn on the SB-80 and how to make backups of your CP/M system disks. It also gives a brief overview of the CP/M system. The third section is a technical section which includes schematics covering the Shugart disk drives and Boschert power supply sold with the system.

The faults I find with the manual are the same as I find with most manuals. They seem to be written by technical people who assume that you already are familiar with their system, or that you have experience with computers of this type. Technicians will find the manual to be very comprehensive. It supplies all the information necessary to get the SB-80 to do what they want it to do and keep it operational. It is not written for the computer novice.

Colonial Data Systems includes a brief tutorial (25 pages) on the CP/M operating system. They also include an on-line CP/M help command. Typing the word help followed by the command you want explained will result in a display of the definition of the command. They also include a program on their distribution disk called "Help Help" which gives descriptions of the programs on the disk.

To show you how the SB-80 computer compares to the other computers on the market, I included a benchmark test (shown in Table 1, courtesy of Bill Gollan and S & M Systems). All benchmarks were run with a Basic interpreter. Compilers were not used because of their obvious speed advantage, and because interpreters are more available and represent a much wider group of machines. The CPUs of the computers are listed along with the clock speeds (in MHz) at which the computers operate. The operating systems and versions of Basic used are also listed. The last item of each line is the name of the person who actually tested the computer.

The benchmark test is a simple one and uses two nested FOR-NEXT loops and IF-THEN tests. The program used was:

```
140 FOR N=1 TO 1000
150 FOR K=2 TO 500
160 LET M=N/K
170 LET L=INT(M)
180 IF L=0 THEN 230
190 IF L=1 THEN 220
200 IF M>L THEN 220
210 IF M=L THEN 240
220 NEXT K
230 PRINT N;
```

240 NEXT N
250 PRINT "FINISHED"

The results of the benchmark test are listed in seconds.

Summary

The SB-80 computer is a well-planned and designed Z-80 computer. Its designers have obviously spent a lot of time and effort in laying out the SB-80 for maximum versatility and convenience. The design of the pin-to-pad RS-232 lines is a much needed setup. More than once I have wanted to connect a standard RS-232 printer to a standard RS-232 port but ran into incompatibility problems. The design of the SB-80 RS-232 ports alleviates this problem.

Another advantage of the SB-80 is the multitude of ready-to-use programs for the CP/M operating system. Although the SB-80 is a new machine, it is not limited by a lack of software.

As you can tell, I am enthusiastic about the capabilities of the SB-80 computer. I think it is definitely one of the better, if not the best, Z-80 computers to be released in the last few years. ■

Circle 397 on Reader Service card.

SPECIAL OFFER

JOURNAL of PASCAL and ADA

- Program design
- Graphics
- New developments
- Applications
- New Products

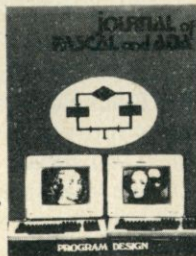

An in-depth resource for the beginner to expert programmer.

6 issues \$14.00
NEWSSTAND \$18.00

- 1 year (6 issues) \$14.00
- Outside U.S. \$21.00
- One trial issue \$3.00

Name _____
Street _____
City _____ State _____
Country _____ Zip _____
 Payment enclosed MasterCard
 American Express VISA
Card # _____
Signature _____

Mail to: Journal of Pascal and Ada
P.O. Box 384 Orem, Utah 84057

Circle 308 on Reader Service card.

COMPUTER CASSETTES 100% ERROR-FREE



LENGTH	12 PACK	24 PACK
C-05	69¢	59¢
C-10	79¢	69¢
C-20	99¢	89¢

- Fully Guaranteed!
- World's Finest Media
- Custom Storage Case, Add 20¢ Each
- UPS Shipping Add \$3.00 Per Pack



FOR ORDERS ONLY
1-800-426-4747
Extension 480



MICRO-80™ INC.
K-2665 NO. BUSBY ROAD
OAK HARBOR, WA 98277

Micro Money-Maker

Join the bank and insurance magnates of the world in understanding the formula to calculate your future financial value. This useful TRS-80 application can be easily converted to other systems.

By Joseph Najjar

This article illustrates and evaluates the impact of future value calculations in financial transactions. It also describes a program for the TRS-80 Model I or Model III computer that calculates future value.

Future value is the amount an investment is worth at a specific future point. The concept is simple. For instance, if you deposit \$100 in a bank that pays 10 percent interest, compounded yearly, the future value after one year would be \$110. But interestingly enough, if the bank across

the street pays 9.56 percent annual interest compounded monthly, at the end of one year that same \$100 would grow to an identical \$110.

The importance to the depositor is not the interest rate quoted or how it is compounded, but the balance at the end of the year.

Why Use Future Value

To properly compare amounts of money, they must be compared at the same point in time. For instance, if you compare \$100 today with \$110 one year from now, you would probably conclude that the \$110 is greater than \$100. However, if you invested today's \$100 at 10 percent interest at the end of one year it would grow to \$110. Financially, this means that, assuming interest rates were at 10 percent, \$100 today is really equal to \$110 one year from now. The future value calculation allows an effective

comparison of sums of money, investment returns and financial alternatives at a future period.

Financial decision-making using large dollar amounts, long periods of time and continuous cash flows can be quite misleading.

As an example, assume you won a \$1 million tax-free lottery. It is to be paid to you in denominations of \$50,000 per year for 20 years, or you may elect to receive a one-time payment of \$350,000. Which would you choose?

Personal circumstances may have a major effect upon the decision. However, the correct financial decision can only be made by a mathematical comparison.

If you chose the \$1 million, you would receive \$50,000 at the end of each year for 20 years. If, however, you chose the \$350,000 and invested it at 13.06 percent compounded yearly, you could also withdraw \$50,000 at the end of each year for 20 years, at which time you would have withdrawn the total balance of the account. Thus, this investment would

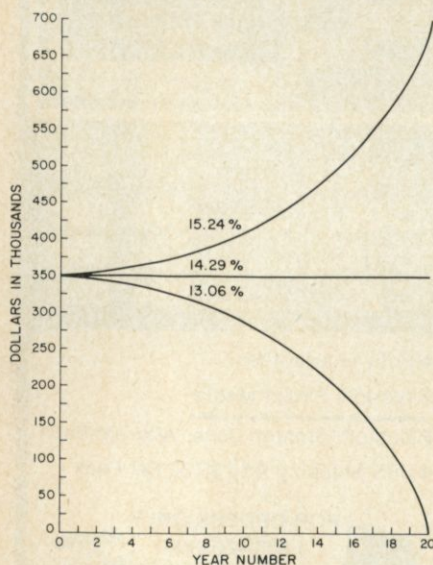

Fig. 1. This chart shows the year-ending balances of \$350,000 invested at 13.06 percent, 14.29 percent and 15.24 percent compounded yearly after withdrawing \$50,000 per year.

Address correspondence to Joseph N. Najjar III, 99 Walker Road, Westwood, MA 02090.

CR_n = Cash flow at period n
 i = The assumed interest rate
 FV = Future value

$$FV = -CF_n(1+i)^0 - \dots - CF_3(1+i)^{n-3} - CF_2(1+i)^{n-2} - CF_1(1+i)^{n-1}$$

Fig. 2. Future value formula.

H & E COMPUTRONICS INC.

• • EVERYTHING FOR YOUR TRS-80™ • ATARI™ • APPLE™ • PET™ • CP/M™ • XEROX™ • IBM™ • •

* TRS-80 is a trademark of the Radio Shack Division of Tandy Corp. - * ATARI is a trademark of Atari Inc. - * APPLE is a trademark of Apple Corp. - * PET is a trademark of Commodore
* CP/M is a trademark of Digital Research - * XEROX is a trademark of Xerox Corp. - * IBM is a trademark of IBM Corp.



★ All orders processed within 24-Hours
★ 30-Day money back guarantee

BUSINESS PAC 100 100 Ready-To-Run Business Programs

(ON CASSETTE OR DISKETTE).....Includes 128 Page Users Manual.....
Inventory Control.....Payroll.....Bookkeeping System.....Stock Calculations.....
Checkbook Maintenance.....Accounts Receivable.....Accounts Payable.....

BUSINESS 100 PROGRAM LIST

NAME	DESCRIPTION
1 RULE78	Interest Apportionment by Rule of the 78's
2 ANNU1	Annuity computation program
3 DATE	Time between dates
4 DAYYEAR	Day of year a particular date falls on
5 LEASEINT	Interest rate on lease
6 BREAKEVN	Breakeven analysis
7 DEPRSL	Straightline depreciation
8 DEPRSY	Sum of the digits depreciation
9 DEPRDB	Declining balance depreciation
10 DEPRDDB	Double declining balance depreciation
11 TAXDEP	Cash flow vs. depreciation tables
12 CHECK2	Prints NEBS checks along with daily register
13 CHECKBK1	Checkbook maintenance program
14 MORTGAGE/A	Mortgage amortization table
15 MULTMON	Computes time needed for money to double, triple, etc.
16 SALVAGE	Determines salvage value of an investment
17 RRVARIN	Rate of return on investment with variable inflows
18 RRCONST	Rate of return on investment with constant inflows
19 EFFECT	Effective interest rate of a loan
20 FVAL	Future value of an investment (compound interest)
21 PVAL	Present value of a future amount
22 LOANPAY	Amount of payment on a loan
23 REGWITH	Equal withdrawals from investment to leave 0 over
24 SIMPDISK	Simple discount analysis
25 DATEVAL	Equivalent & nonequivalent dated values for oblig.
26 ANNUDEF	Present value of deferred annuities
27 MARKUP	% Markup analysis for items
28 SINKFUND	Sinking fund amortization program
29 BONDVAL	Value of a bond
30 DEplete	Depletion analysis
31 BLACKSH	Black Scholes options analysis
32 STOCVAL1	Expected return on stock via discounts dividends
33 WARVAL	Value of a warrant
34 BONDVAL2	Value of a bond
35 EPSEST	Estimate of future earnings per share for company
36 BETAALPH	Computes alpha and beta variables for stock
37 SHARPE1	Portfolio selection model-i.e. what stocks to hold
38 OPTWRITE	Option writing computations
39 RTVAL	Value of a right
40 EXPVAL	Expected value analysis
41 BAYES	Bayesian decisions
42 VALPRINF	Value of perfect information
43 VALADINF	Value of additional information
44 UTILITY	Derives utility function
45 SIMPLEX	Linear programming solution by simplex method
46 TRANS	Transportation method for linear programming
47 EOQ	Economic order quantity inventory model
48 QUEUE1	Single server queueing (waiting line) model
49 CVP	Cost-volume-profit analysis
50 CONDPFROF	Conditional profit tables
51 OPTLOSS	Opportunity loss tables
52 FQIOQ	Fixed quantity economic order quantity model
53 FQEOQSH	As above but with shortages permitted
54 FQEQPB	As above but with quantity price breaks
55 QUEUECB	Cost-benefit waiting line analysis
56 NCFANAL	Net cash-flow analysis for simple investment
57 PROFIND	Profitability index of a project
58 CAP1	Cap. Asset Pr. Model analysis of project

59 WACC	Weighted average cost of capital
60 COMPBAL	True rate on loan with compensating bal. required
61 DISCBAL	True rate on discounted loan
62 MERGANAL	Merger analysis computations
63 FINRAT	Financial ratios for a firm
64 NPV	Net present value of project
65 PRINDLAS	Laspeyres price index
66 PRINDPA	Paasche price index
67 SEASIND	Constructs seasonal quantity indices for company
68 TIMETR	Time series analysis linear trend
69 TIMEMOV	Time series analysis moving average trend
70 FUPRINF	Future price estimation with inflation
71 MAILPAC	Mailing list system
72 LETWRT	Letter writing system-links with MAILPAC
73 SORT3	Sorts list of names
74 LABEL1	Shipping label maker
75 LABEL2	Name label maker
76 BUSBUJ	DOME business bookkeeping system
77 TIMECLCK	Computes weeks total hours from timeclock info.
78 ACCTPAY	In memory accounts payable system-storage permitted
79 INVOICE	Generate invoice on screen and print on printer
80 INVENT2	In memory inventory control system
81 TELDIR	Computerized telephone directory
82 TIMUSAN	Time use analysis
83 ASSIGN	Use of assignment algorithm for optimal job assign.
84 ACCTREC	In memory accounts receivable system-storage ok
85 TERMPAY	Compares 3 methods of repayment of loans
86 PAYNET	Computes gross pay required for given net
87 SELLPR	Computes selling price for given after tax amount
88 ARBCOMP	Arbitrage computations
89 DEPRSF	Sinking fund depreciation
90 UPSZONE	Finds UPS zones from zip code
91 ENVELOPE	Types envelope including return address
92 AUTOEXP	Automobile expense analysis
93 INSFIL	Insurance policy file
94 PAYROLL2	In memory payroll system
95 DILANAL	Dilution analysis
96 LOANAFFD	Loan amount a borrower can afford
97 RENTPRCH	Purchase price for rental property
98 SALELEAS	Sale-leaseback analysis
99 RRCONVBD	Investor's rate of return on convertible bond
100 PORTVAL9	Stock market portfolio storage-valuation program

- TRS-80 Cassette Version \$99.95
- TRS-80 (Mod-I or III), Pet, Apple or Atari Versions \$99.95
- TRS-80 Mod-II, IBM, Osborne and 8" CP/M Versions \$149.95

ADD \$3.00 FOR SHIPPING IN UPS AREAS
ADD \$4.00 FOR C.O.D. OR NON-UPS AREAS
ADD \$5.00 TO CANADA AND MEXICO
ADD PROPER POSTAGE OUTSIDE OF U.S., CANADA AND MEXICO

COMPUTRONICS
MATHEMATICAL APPLICATIONS SERVICE™

50 N. PASCACK ROAD
SPRING VALLEY, NEW YORK 10977

ASK FOR OUR 64-PAGE CATALOG

**NEW TOLL-FREE
ORDER LINE**
(OUTSIDE OF N.Y. STATE)
(800) 431-2818

**24 HOUR
ORDER LINE**
(914) 425-1535

ALL PRICES & SPECIFICATIONS SUBJECT TO CHANGE
DELIVERY SUBJECT TO AVAILABILITY

be identical in value to taking the \$1 million over 20 years.

If you had been able to invest that same \$350,000 at 14.29 percent compounded yearly (only 1.23 percent more than the previous 13.06 percent), you could withdraw \$50,000 at the end of each year for an infinite amount of time, and the year-ending balance would always be \$350,000.

Better still, if you were able to invest it at 15.24 percent compounded yearly, you could withdraw \$50,000 at the end of each year also for an infinite amount of time, with your balance doubling at the end of year number 20 to \$700,000.

See Fig. 1 to observe the effect that interest rates have on the year-ending balances.

How to Use Future Value

The future value formula is shown in Fig. 2. The Future Value program in Listing 1 written on a TRS-80 Level II computer requires at least 8K bytes of memory.

Load the program and type RUN. Immediately following this, three columns will appear. The first column is labeled "period number." You can designate the length of a period, but each period must consist of that equal length. For instance, if you consider period 1 to be one month long, you must consider all subsequent periods to be one month long. The computer automatically inserts the period number, it then moves to the second column labeled "cash flow amount" and will await your input. In the cash flow column, enter the cash flow amount for that period. Sign designation is as follows: negative numbers signify money leaving your pocket, going into the investment; positive numbers signify money going into your pocket from the investment.

After putting in the sign designation and the cash flow amount, the cursor moves to column 3 labeled "number of consecutive similar cash flows." This column can save a considerable amount of typing. Let's assume you input a cash flow amount of -\$500 for period 1 and that the cash flow amount for periods 2 through 5 is also -\$500, equaling a total of five consecutive -\$500 cash flows. By typing a five in this column, the computer would automatically input periods two through five at the -\$500 value. If this input is less than one or a noninteger, the computer disregards the entire line and asks

Program listing. Future Value program for the TRS-80. (Microcomputing will publish conversions of this program for the Apple, Atari, Commodore, Heath, . . . , submitted by our readers.)

```

10 CLS
20 '*****
30 'X
40 'X THIS PROGRAM CALCULATES THE FUTURE VALUE OF CASH FLOWS X
50 'X WRITTEN BY ... JOE NAJJAR III X
60 'X X
70 'X X
80 '*****
90 '
100 '*****
110 'X
120 'X INITIALIZE PROGRAM TO ACCEPT 100 DIFFERENT CASH FLOW AMOUNTS X
130 'X X
140 'X CF(X)=CASH FLOW AMOUNT NUMBER X X
150 'X X
160 'X N(X)=NUMBER OF CONSECUTIVE REPETITIONS OF CASH FLOW NUMBER X X
170 'X X
180 '*****
190 C=1:L=193:P=1
200 DIM CF(100),N(100)
210 '*****
220 'X
230 'X REQUEST INPUTS FOR CASH FLOW AND CONSECUTIVE PERIODS X
240 'X X
250 '*****
260 PRINT @0, *PERIOD CASH FLOW NO. OF CONSECUTIVE
270 PRINT *NUMBER AMOUNT SIMILAR CASH FLOWS*
280 PRINT @L,P;TAB(23);
290 A$=""
300 INPUT A$
310 IF A$="END"AND C<>1 THEN 470
320 CF(C)=VAL(A$):IF CF(C)=0 AND A$<>"0" THEN 380
330 PRINT @L+52,"";
340 N(C)=1
350 INPUT N(C):IF N(C)<>INT(N(C))OR N(C)<=0 THEN 380
360 IF N(C)>1 THEN GOSUB 410
370 C=C+1:P=P+1
380 IF L<896 THEN L=L+64
390 PRINT
400 GOTO 260
410 FOR X=2 TO N(C)
420 P=P+1
430 IF L<896 THEN L=L+64
440 PRINT
450 PRINT @L,P;TAB(24);CF(C)
460 NEXT X:RETURN
470 C=C-1
480 '*****
490 'X
500 'X REQUEST INTEREST RATE ASSUMPTION AND STORE IN VARIABLE II X
510 'X X
520 '*****
530 INPUT *WHAT IS THE ASSUMED INTEREST RATE PER PERIOD (IN %) *;II
540 IF II=0 THEN 530
550 II=II/100
560 '*****
570 'X
580 'X CALCULATE THE FUTURE VALUE X
590 'X X
600 '*****
610 NN=0:T=0
620 FOR X=C TO 1 STEP -1
630 FOR Y=1 TO N(X)
640 NN=NN-CF(X)*(1+II)^T
650 T=T+1
660 NEXT Y:NEXT X
670 FV=NN
680 '*****
690 'X
700 'X VIDEO DISPLAY OF RESULT X
710 'X X
720 '*****
730 CLS:PRINT:PRINT *THE FUTURE VALUE IS --- *;FV
740 '*****
750 'X
760 'X ASK IF HARD COPY IS DESIRED X
770 'X X
780 '*****
790 A$=""
800 PRINT:INPUT *DO YOU WANT A HARD COPY PRINT OUT (Y OR N) *;A$
810 IF A$="Y" THEN GOSUB 1010
820 IF A$<>"N" THEN 800
830 A$=""
840 '*****
850 'X
860 'X ASK FOR NEW INTEREST RATE ASSUMPTION AND RECALCULATE X
870 'X X
880 '*****
890 INPUT *DO YOU WANT TO RECALCULATE AT A DIFFERENT INTEREST RATE *;A$
900 IF A$="Y" THEN 530
910 IF A$<>"N" THEN 890
920 '*****
930 'X
940 'X ASK IF COMPLETE PROGRAM RERUN IS DESIRED X
950 'X X
960 '*****
970 A$=""
980 INPUT *DO YOU WANT TO RUN AGAIN FROM SCRATCH (Y OR N) *;A$
990 IF A$="Y" THEN RUN
1000 IF A$="N" THEN END ELSE 980
1010 A$=""
1020 '*****

```

More →

DISCOUNT

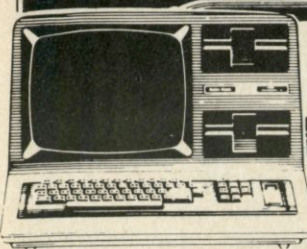

TRS-80®

TRS-80 MODEL III
\$1950 \$819
 48-K 26-1066 16-K 26-1062

TRS-80 MODEL II
\$3000
 64-K 26-4002
 TRS-80 8.4 MEGABYTE HARD DISKS (PRIMARY UNIT) . . . \$400.

TRS-80 MODEL 16
\$4825
 128-K 26-6002

TRS-80 COLOR **\$309**
 16-K 26-3004

\$425
 16-K 26-3002

\$525
 32-K 26-3003

WE HAVE COLOR DISK DRIVES 0 — \$475 1-2-3 — \$315

WE ALSO CARRY EPSON AND OKIDATA PRINTERS, XEROX 820 AND ALTOS COMPUTERS. NO OUT-OF-STATE TAXES. T.M. TANDY CORP
 Sold with the manufacturer's limited warranty. Copies of such warranty may be obtained for review from Perry Oil and Gas Co.

PERRY OIL & GAS INC.
 Dept. No. M-13 137 NORTH MAIN ST., PERRY, MICHIGAN 48872
 PHONE (517) 625-4161. MICH
 FOR OUR PRICES, PLEASE CALL TOLL FREE
1-800-248-3823

WE ACCEPT CERTIFIED CHECKS, CASHIERS CHECKS AND MONEY ORDERS

YOU'VE JUST FOUND THE MISSING LINK!





Computer Shopper is your link to individuals who buy, sell and trade computer equipment and software among themselves nationwide. No other magazine fills this void in the marketplace chain. Thousands of cost-conscious computer enthusiasts save by shopping in Computer Shopper every month through hundreds of classified ads. And new equipment advertisers offer some of the lowest prices in the nation. Computer Shopper's unbiased articles make for some unique reading among magazines and there's a "help" column to answer difficult problems you may have with interfacing, etc.

For a limited time you can subscribe to Computer Shopper with a 6 month trial for only \$6 or 12 months for only \$10. MasterCard & VISA accepted.

6 month trial, \$6 or 12 months for only \$10



COMPUTER SHOPPER
 P.O. Box F-330 • Titusville, FL 32780
 305-269-3211

Computer Case Company

AN OPEN AND SHUT CASE FOR COMPUTERS



CALL TOLL FREE:
(800) 848-7548

AP103

Your sizable investment in your computer should be protected. If you have to load and unload your computer every time you want to move it, you must consider the possible damage. Computer Case Company has solved your computer protection problem. Once your equipment is safely inside the attache-style carrying case, it never has to be taken out again. Simply remove the lid, connect the power, and operate. For storage, disconnect the power, enclose your disks, working papers, and manuals in the compartments provided, and attach the lid. Case closed. Judge for yourself.

- AP101 Apple II with Single Disk Drive \$109
- AP102 Apple II with Double Disk Drive 119
- AP103 Apple II, 9 inch Monitor & Double Drives 129
- AP104 Apple III, two additional Drives & Sitentype 139
- AP105 12 inch Monitor plus accessories 99
- RS201 TRS-80 Model I, Expansion Unit & Drive 109
- RS-202 TRS-80 Model or TV set 84
- RS204 TRS-80 Model III 129
- RS-205 Radio Shack Color Computer 89
- AT301 Atari Computer & Accessories 109
- P401 Paper Tiger 440/445/460 99
- P402 Centronics 730/737 Line Printer II/IV 89
- P403 Epson MX70, MX80 or IBM Matrix 89
- P404 Epson MX100 99
- P405 IDS 560 or Prism Printer 109
- IB501 IBM Personal Computer 129
- IB502 IBM Monitor 99
- CC80 Matching Attache Case (5") 85
- CC90 Matching Attache Case (3") 75
- CC91 Matching Accessory Case 95

5650 Indian Mound Court • Columbus, Ohio 43213 • (614) 868-9464



Listing continued.

```

1030 'x
1040 'x      HARD COPY PRINT OUT SUBROUTINE
1050 'x
1060 '*****
1070 FOR X=1 TO 5:LPRINT " ":NEXT X
1080 LPRINT "FUTURE VALUE SUMMARY":LPRINT " "
1090 LPRINT "ASSUMED INTEREST RATE PER PERIOD";II*100;"%":LPRINT " "
1100 LPRINT "CASH FLOW DETAIL":LPRINT " "
1110 LPRINT "PERIOD"," ", "CASH FLOW","NO. OF CONSECUTIVE"
1120 LPRINT "NUMBER"," ", "AMOUNT","SIMILAR CASH FLOWS"
1130 LPRINT " "
1140 P=1:FOR X=1 TO C
1150 LPRINT " ";P;" ", " ";CF(X)," " ";N(X)
1160 P=P+N(X):NEXT X
1170 LPRINT " ":LPRINT " ":LPRINT " "
1180 LPRINT "FUTURE VALUE = $":FV:RETURN

```

you to re-enter it.

After you've entered all of the cash flows for all of the periods, type END for the next cash flow amount. A question then appears asking for an interest rate assumption (the interest rate you are currently earning on your investments). It's important that you enter the interest rate for one period's length of time. For instance, if a period was one month long and you were assuming 18 percent interest per year, you would enter the interest as 1.5 (i.e., $18/12 = 1.5$). If a period length equaled one year and interest was 18 percent per year, you

would enter 18.

Next, the machine—taking up to several seconds—calculates the future value, displays it on the screen and asks if you want a hard copy summary of the analysis (see Fig. 3).

A positive future value is the amount you could put into your pocket from the investment after the last entered period. A negative future value would be the amount of money you would owe on the investment.

Next, a question asks if you would like to recalculate the future value at a different interest rate assumption.

The machine will then ask if you want to start from scratch. An N will end the program.

An Example

Using the steps I've just outlined, let's actually calculate the lottery example.

First type RUN; the three columns will appear. The cursor will fill in the number 1 under the period number column, and then move to the cash flow column looking for an input. The first cash flow is \$350,000 leaving your pocket, so enter $-\$350,000$. The cursor will then jump to the next column. Since the next cash flow is not a consecutive similar cash flow, just press the enter key and the computer will automatically assume you want the $-\$350,000$ only in period 1. The computer will then print the number 2 under the period number column and await the next cash flow.

Since you'll be withdrawing \$50,000 from the investment into your pocket, enter \$50,000. The cursor will then jump to column three. This time you'll enter the number 20, because you'll be taking out \$50,000 for 20 consecutive periods. The computer will then automatically fill in the next 19 periods with \$50,000.

Now type END for the next cash flow; the interest rate assumption

question will appear. Enter the annual interest rate (because each period equals one year) that you feel you can earn and the computer will, after a few seconds, respond with the future value. In my illustration I used 13.06, 14.29 and 15.24 percent to illustrate the interest rates required to generate future values of \$0, \$350,000 and \$700,000 respectively.

Armed now with your new valuable tool, assume your insurance man wants to sell you a retirement plan. Your obligation would be to invest \$150 per month for 360 months (30 years), for a total of \$54,000. The insurance company's responsibility would then be to pay you \$5000 per month for 300 months (25 years) for a total of \$1,500,000.

After explaining this, the insurance man asks you if you're interested in the plan. The average person would jump at the chance to turn \$54,000 into \$1.5 million. But you, knowing better, realize a more sophisticated financial analysis is necessary before coming to a conclusion. You can now evaluate the possibilities of this plan with the Future Value program by comparing it to an investment in a money market fund.

Load and run your Future Value program. In period number 1, enter $-\$150$. Because you're going to make 360 payments (30 years), type in 360 for the number of consecutive similar cash flows.

Next, the computer automatically inputs $-\$150$ for periods 2 through 360, displays it on the screen and moves to period number 361, which is the month during which you start withdrawing \$5000 per month. Because this is cash going into your pocket, enter \$5000 for the cash flow of period 361. Since you expect to withdraw the \$5000 amount for 300 months (25 years) enter 300 for the number of consecutive similar cash flows. The computer will then fill in withdrawals for periods 361 through 660 and the cursor will move to period 661. Type END, signifying the end of the cash flow sequence. The interest rate assumption question will then appear on the screen. Assuming you can earn 1 percent per month, type in 1, which represents this interest rate. The computer, several seconds later, will respond with the future value of \$979,312.

From this, your conclusion is that if you had made payments of \$150 per month for 360 months and then withdrew \$5000 per month for 300

Circle 399 on Reader Service card.

UNIFORTH

FORTH is a highly interactive, extensible language that runs 10-30x faster than interpreted BASIC and in less memory. UNIFORTH adheres to the 1979 FORTH International Standard and is available for any Z-80 and most 16-bit processors using ROM-based I/O and 8" floppy disks. Standard features:

- Stand-alone (no operating system needed)
- Menu-driven cursor-addressed video editor
- Full assembler (manufacturer's mnemonics)
- IEEE-compatible software floating point (with transcendental functions)

Options include: Formatting, DBMS, floating point processor (9512, 8087, 16081) support, terminal emulator, CP/M and RT-11 file transfer, games, printer graphics, Metaforth cross-compiler, etc.

Version 1 UNIFORTH, no floating point	\$ 60
Version 2 UNIFORTH, with floating point	\$ 100
Version 3 UNIFORTH, f.p. and multitasking	\$ CALL

Prices include postage in Continental U.S.
Please write for further details.

UNIFIED SOFTWARE SYSTEMS
P.O. BOX 2644
NEW CARROLLTON, MD 20784
(301) 552-1295

months for an investment that paid you 1 percent per month, you would still have a future value cash balance of \$979,312.

Under the terms of the insurance company retirement plan, you would have made the same payments over 30 years, and received the same income over the last 25 years, but would have no value thereafter.

Your own investment, as you can conclude, is far superior to that of the insurance company. It is becoming increasingly clear why insurance companies can pay for such large office buildings.

Now let's assume you are a home builder. You plan to build a house with \$60,000 of borrowed funds. You feel certain you can sell the house at \$70,900. Your cash disbursements (which you borrow from the bank) are shown in Table 1.

The bank decides to loan you the money at 1.5 percent per month (18 percent per year). You commence

(sale price) minus \$62,319 (month 5 bank loan balance) equals \$7681 (profit).

Because you decided to hold out to get your full asking price of \$70,900 and the buyer didn't agree to this until period number 12, you would calculate your earnings as follows.

Again enter for periods 1 through 5 - \$20,000, -\$15,000, -\$10,000, -\$7000 and -\$8000 respectively. Also enter 0 for period 6 and type 7 under the number of consecutive similar cash flows, because for seven months you had no cash flows in this transaction. Again, answer the inter-

Month	Cash Paid Out	Reason
1	\$20,000	Purchase land
2	\$15,000	Foundation and starting construction
3	\$10,000	Finish exterior
4	\$ 7,000	Finish interior
5	\$ 8,000	Landscaping and appliances
Total	\$60,000	

Table 1. Sample cash disbursements to build a house.

It is becoming increasingly clear why insurance companies can pay for such large office buildings.

construction, all goes well and you finish at the end of the fifth month. Also at the end of the fifth month, John Jones makes an offer to purchase it at a price of \$70,000. You explain your asking price of \$70,900 and refuse his offer. Seven months later, Mr. Jones comes back and agrees to pay your \$70,900, which makes you very happy.

Using the Future Value Analysis, let's calculate the amount of profit at those two points in time.

First, let's calculate how much money you would have made if you sold it at the end of the fifth month for \$70,000. Enter for months 1 through 5: -\$20,000, -\$15,000, -\$10,000, -\$7000 and -\$8000 respectively. Answer the interest question with 1.5. The future value, in this case, being the amount you owe the bank, is \$62,319. If you accepted the \$70,000 offer, you would have earned a profit of \$7681; i.e., \$70,000

Circle 375 on Reader Service card.

A FULL LINE OF SEMIDISKS

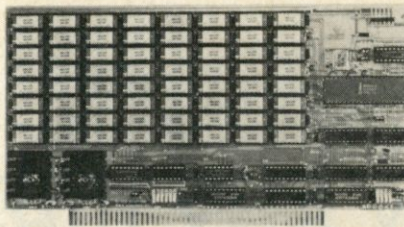

S-100

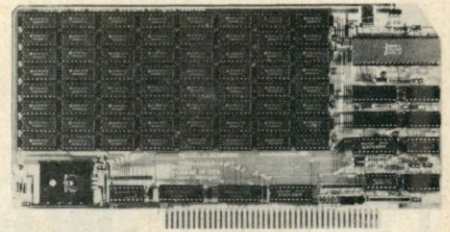

TRS 80 Model 2

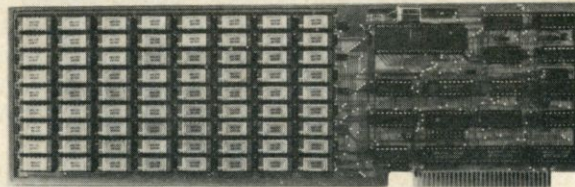

IBM Personal Computer

Do you use your computer? Or does your computer "use" you? Face it, if you're using floppies, your time is being wasted. Because a floppy is an inefficient random access storage device. Each time the processor wants to transfer data, it has to wait an eternity for the disk to rotate and the head to move.

So what do you do? Get a SemiDisk, quick. It's a large capacity semiconductor memory board that is driven by software to operate like a disk drive. Without all the waiting. Do everything you'd do on a floppy or hard disk, with no modifications to your software or hardware. Two board sizes are available: 512K and 1 Megabyte. (the highest density microcomputer memory board in the world) And you can put up to 8 megabytes in a system by adding more storage boards.

What do you need to use it? Just an S-100 system with CP/M 2.2. Or a TRS-80 Model 2 system with CP/M 2.2. Or an IBM Personal Computer. That's it. No special processors, DMA, I/O, or disk controllers are required. Plug it in and run the installation program, and you're on your way. Fast! Even better, we supply full source code to the driver software, in case you'd like to do your own interfacing.

Best of all, the SemiDisk's price won't warp your wallet. Compare specs, cost/megabyte, storage capacity, and compatibility with the competition. You'll see that the SemiDisk is a disk emulator truly worthy of the name. SemiDisk has battery-backup capability, too.

Consider our limited warranty: A full year, covering all parts and labor. Consider our liberal 15 day return policy. Price? \$1995 for 512K byte SemiDisk, \$2995 for 1 Megabyte SemiDisk. Both from stock. \$10.00 for manual. VISA, Mastercard, COD orders accepted. Dealer and OEM inquiries welcomed. (Specify system type and disk format when ordering.)

Someday, you'll get a SemiDisk.
Until then, you'll just have to wait.

**SemiDisk
SYSTEMS**

P.O. Box GG
Beaverton, OR 97075 (503)-642-3100



Call (503)-646-5510 for CBBS®/NW, a Semi-Disk-equipped computer bulletin board. SemiDisk trademark of SemiDisk Systems; TRS-80 trademark of Radio Shack

est question with 1.5 and the resulting future value, which again represents the amount you owe the bank at that point, will be \$69,165. Your profit is then \$1735; i.e., \$70,9000 (sale price) minus \$69,165 (month 12 bank loan balance) equals \$1735 (profit). Had you sold the house for \$70,000 at the end of the fifth month, your profit would have been approximately 4½ times higher than waiting an additional seven months to achieve your firm asking price of \$70,900.

Program Construction and Execution

Initialization is in lines 190-200. Line 190 sets needed pointers for the input routine, while line 200 finds variable space for a maximum of 100 nonconsecutive cash flows and the number of consecutive entries for each.

The input routine is from lines 260-470. After this step, the computer retains variables CF(X) (cash flow), N(X) (periods of consecutive cash

flows) and C (the number of different entries).

Next, the computer receives your assumed interest rate, lines 530-550, and stores it in decimal form in the variable II.

Next is the calculation routine, lines 610-670. These lines may be used in your own financial program and will store the correct answer in variable FV if the above retained variables contain the appropriate value and II contains the decimal equivalent of the interest rate compounded per period.

The video display sequence, line 730, simply displays the future value on the screen.

Lines 790-830 ask if a hard-copy printout is desired, and if so goes to lines 1070-1180 (the hard-copy printout routine); otherwise the program continues to flow as follows.

The program asks if a new assumed interest rate is desired (lines 890-910), and if so goes to the interest request routine.

The next routine, lines 970-1010, asks if you want a complete rerun. If so, it activates the run command; if not, it ends. ■

ASSUMED INTEREST RATE PER PERIOD 1.5%		
CASH FLOW DETAIL		
PERIOD NUMBER	CASH FLOW AMOUNT	NO. OF CONSECUTIVE SIMILAR CASH FLOWS
1	-20000	1
2	-15000	1
3	-10000	1
4	-7000	1
5	-8000	1
6	0	7

FUTURE VALUE = \$69165.1

Fig. 3. Hard copy summary of sample analysis.

Circle 206 on Reader Service card.

TRS-80™ - WHY BUY DIRECT?

Buying a GENUINE TRS-80 direct, literally, means buying from the Tandy Warehouses in Fort Worth. For the end user this is not possible. However, the closer a retailer is located to the source the lower his cost per unit and the closer his buyer can come to "almost" buying direct. WE ARE CLOSER so WE SELL LOWER. It only takes a FREE phone call to verify this FACT.

WARRANTY:

ONLY A GENUINE TRS-80 purchased from an Authorized-Outlet can have the Radio Shack Warranty. BUYER BEWARE OF IMITATIONS.



This Month SPECIAL
Model III 48k 2 Drives RS232
\$1895

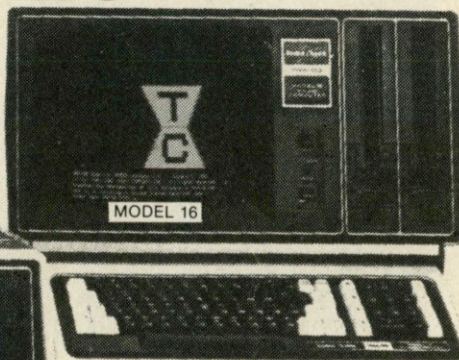
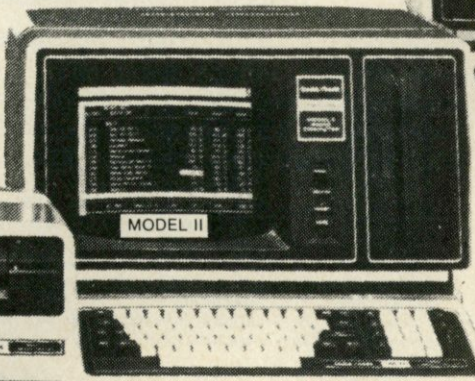

SAVE SALES TAX* PLUS DISCOUNT

*TEXAS RESIDENTS ADD ONLY 4%

"WE ARE CLOSER"

FORT WORTH COMPUTERS

IN TEXAS CALL 817-573-4111

TOLL FREE ORDER NUMBER: 1-800-433-S-A-V-E

TM: TRADE MARK OF THE TANDY CORPORATION

377 PLAZA GRANBURY • FORT WORTH • TEXAS 76048

Micro-Grip™

FRICTION FEED FOR YOUR EPSON
MX-70* or MX-80*

*MX-70 and MX-80 are Trademarks of EPSON, Inc.

- Converts your printer for friction feed of SINGLE SHEETS or ROLL PAPER.
- SIMPLE Installation (all you need is a screwdriver, no soldering).
- Tractor feed remains undisturbed.
- Only **\$39⁹⁵**
(add \$1.50 for postage)



SATISFACTION GUARANTEED OR YOUR MONEY BACK



MICRO-GRIP, Ltd.
P. O. Box 4278
Norton AFB, CA 92409

VISA & Master Card Accepted
(714) 864-6643

TEACHING

WILL NEVER BE THE SAME AGAIN!



INTRODUCING
Torricelli
author

A powerful authoring and presentation program that allows teachers without programming experience to create effective training and education courses. Specifically designed for Business, Industry, Education and Home use.

Features include:

- Built-in full screen editor using WordStar™ commands for rapid on-screen editing and course generation.
- Creation of courses for mass distribution is fully supported. 20% royalties for courses submitted for our courseware catalog.

Requires CP/M™ 2.2, 48K, and 24 x 80 CRT. Available on 8" (3740) Single Density Disk. Contact distributors for other formats.

Package includes: Torricelli Author program, a linear presentation program, complete documentation, two courses of instruction and description of the entire educational software line. **\$295.**

California residents add 6% tax. Visa/MasterCard accepted.

*CP/M is a trademark of Digital Research.
*WordStar is a trademark of Micro Pro Int.

**THE ANSWER
IN COMPUTERS**
6035 University Avenue, #7
San Diego, CA 92115
714-287-0795

Super Compuprism Color Graphics

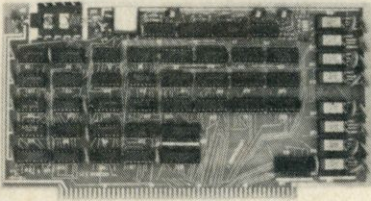

Z-80 Users You Can Use TRS-80* Software

We offer an assembled hardware interface which we guarantee will load data from TRS-80* cassettes into any Z-80 based system. (Except sealed units.) The documentation explains how to patch the TRS-80* software to your system. In fact you can virtually change your Z-80 machine into a TRS-80* without making a single hardware change. The documentation also includes an example of patching SARGON II** into a Z-80 system.

The price is \$30 or FREE with the purchase of an assembled compuprism or super compuprism unit.

A-D, D-A Board

S-100 board provides 16 channels of analog to digital input and 8 channels of digital to analog output. With on board kluge area. Total cost of board and parts less than \$120. Bare board with documentation \$45.

For the S-100 Bus. 32K of on board memory allows a 288 H. x 192V. dot matrix, for a total of 55,296 pixels. Every pixel is programmable in any one of 16 colors or 16 grey levels completely independent of all other pixels in the matrix.

Compuprism Bare Board with documentation \$45, kit \$240, ass. and tested \$280.
(16K Memory 144H. x 192V.)
Super Compuprism Bare Board with documentation \$50, kit \$350, ass. and tested \$395.
(32K Memory 288H. x 192V.)
Add \$15 to A & T price for 16 level grey scale.
Add \$15 to A & T price for memory management port.

Compuprism software package, includes alpha-numeric, point plot, line draw, and TRS-80* graphics simulation \$20 or FREE with A & T unit.

ALL COD ORDERS SHIPPED WITHIN 72 HOURS. 4MHz MOD FOR S.D. SYSTEMS. EXPANDORAM \$10.

**J.E.S. GRAPHICS, P.O. Box 2752
Tulsa, OK 74101, (918) 742-7104**

TRS-80* is a trademark of Tandy Corp.
SARGON II** is a trademark of Hayden Book Co.



Go FORTH and Prosper

With Timin FORTH, the unusually fast, elegant and versatile superset of FIG FORTH.

Lifeboat Associates offers this powerful, threaded, interpretive and structured language including a memory resident operating system, text editor, assembler and debugger. This extended FORTH is also enhanced by:

- a visual screen editor with string search and replace
- CP/M-80 file format compatibility
- many additional FORTH words
- array handling (implemented in machine code)
- FORTH assembler for 8080/Z80™ machine instructions
- full floating-point capability

Use this complete interactive software development system to slash software development time and shrink system memory requirements.

For more information about Timin FORTH or any of the other 200+ software packages available for use in professional, personal, and programming environments under SB-80™ or other CP/M®-80 compatible operating systems. IBM PC DOS, or MSTM-DOS (SB-86) contact: Lifeboat Associates, 1651 Third Avenue, NY, NY 10028. (212) 860-0300. TWX: 710-581-2524 (LBSOFT NYK); Telex: 640693 (LBSOFT NYK).

SB-80, SB-86, trademarks Lifeboat Associates
MS, trademark Microsoft, Inc.
Z80, trademark Zilog, Inc.
CP/M, registered trademark Digital Research, Inc.
Copyright©1982, by Lifeboat Associates

The One Printer Solution

Centronics' Printstation 350 Series answers office needs.

Centronics recently announced a completely new printer family intended as a one printer solution to multiple office needs. A second new office printer is now available (see sidebar).

Billed as a new generation of printers, the Centronics Printstation 350 Series was designed to offer answers to virtually all office needs. Combining new technology with the best in existing printer ideas, it offers users a creative combination of answers to a variety of office problems at a reasonable cost.

The 350 Series are dot matrix printers, with all the traditional advantages of dot matrix over impact printers. They are faster and much quieter than impact printers and have a graphics capability that allows them to produce high-quality diagrams, charts and special, user-designed symbols. They are capable of 200 characters per second in the data processing mode.

The 350 Series printers also have a built-in correspondence quality mode. This multi-pass capability slows the machines to 50 characters per second, but allows them to produce a print that readers will not be able to distinguish from impact print without close examination. The quality is high enough for business correspondence, report generation and book-length manuscript production.

The machines are designed to switch quickly and easily from fan-

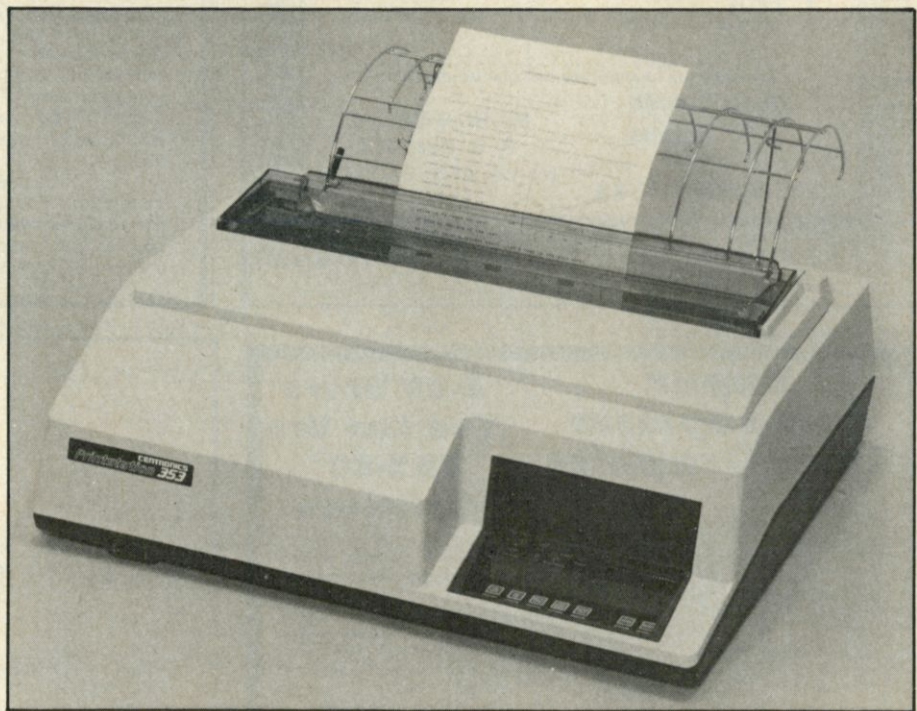

The Centronics Printstation 353.

fold to cut-paper application. While many printers can theoretically handle either, in most cases changing from one to another is a complex and, at times, dirty job. On the 350 Series changing from fan-fold to cut-sheet paper is simply a matter of backing the fan-fold paper out of the printer and moving a lever. This takes advantage of one of the printers' more distinctive capabilities—the ability to feed cut sheets forward or backward.

This ability is at the heart of the Series 350's unique approach to loading stationery and other cut sheets for printing. Virtually all computer printers today either accept sheets

typewriter-style, making it necessary to put the sheets in upside down and backward, or take them from underneath. The Series 350 printers accept sheets from above and in front of the roller. They simply roll them downward along the same track they will follow while being printed. Furthermore, they include an automatic alignment mechanism that insures that each sheet is correctly positioned as it goes into the machine.

Hidden Tractor Feeds

Another distinctive aspect of the printers' design that facilitates changing paper is the placement of the trac-

Reprinted with permission from Desktop Computing, April 1982.

tor feeds. Virtually every printer on the market puts these above the printhead so they can pull fan-fold paper through.

This eliminates design problems in the paper feed, but wastes a sheet of paper every time a user removes a document from the machine. The Centronics Printstation 350 Series' tractor feeds are below the printhead, where they push the paper through the machine. This arrangement saves paper by allowing the user to tear off forms an inch above the printhead.

The printers are designed to handle up to six-part forms and can take either top or bottom glued forms. They cannot accept card forms, however. They accept up to 15-inch-wide fan-fold paper and 12-inch-wide cut-sheets. The reason for the narrower cut-sheet paper is that it must fit between the non-removable tractors when it is inserted into the machine. Form lengths are almost totally adjustable thanks to the programmable aspect of the new printers.

Simplified Design

Maintenance is another major issue that Centronics has addressed in several ways. It has minimized the need for major service by building very dependable machines. The modular design has eliminated many moving parts, and the printers have tested to 3000 hours of mean time between failures, averaging out to a full year between maintenance calls. When repairs are needed, the modular design allows technicians to unplug the offending part and replace it, resulting in a very fast turnaround.

Centronics has also simplified normal office maintenance. The printheads (the part that gets the most wear) are designed to snap in simply, making it possible for office staff members to change printheads without calling in a technician.

The messiest maintenance job—changing the ribbon—is also the most frequent. Centronics has addressed this problem in two ways. First, it provides a long-life ribbon with a 10-million-character capacity. Second, when a ribbon does have to be changed, the operator does not have to thread it through the printhead. Instead, each ribbon comes pre-threaded through a clip that snaps in place on the printhead, eliminating direct handling of the ribbon.

"Special" Standard Features

The machines contain a program-

mable computer chip, which contains eight resident character sets. This allows the printers to handle British, French, German, Italian, Swedish, Finnish, Danish, Norwegian and Spanish characters. Another chip contains a 2000-character buffer, allowing it to hold a business letter or memo in its memory while printing it, freeing the computer for

other uses. In addition, the firmware does automatic self-diagnosis on the machines when they are turned on, identifying any problems.

These features, Centronics points out, are standard on these machines. Centronics expects the price range, from \$1795 for the basic 200 CPS Data Processing version to \$2495 for the high-end machine with multi-

Centronics' Graphics Printer

Centronics Data Computer Corp. now offers the Model 122 graphics dot matrix printer, a heavy-duty printer suited for both data processing and business applications.

The Model 122 is an industrial grade, 132-column data processing printer combined with standard pin-addressable graphics for business processing or design graphics applications. You can select standard alphanumeric printing and pin-addressable graphics, and you also have the choice of six- or eight-pin graphics. This flexibility makes the Model 122 software-compatible with the Centronics Model 739, giving the user a broad base of readily available software packages to perform applications such as trend analysis,

business graphics, pie charts, bar codes, CAD/CAM draft plots, and data processing printing.

Standard features of the Model 122 graphics include 120 cps bidirectional, logic seeking printing in the monospaced alphanumeric mode; unidirectional, logic seeking printing in the graphics mode; six- or eight-pin graphics, selectable forms length (from 3½ inches to 15½ inches in ½-inch increments), selectable lines per inch (6, 9 or 18 lpi), "clean hands" ribbon cassette and seven resident international character sets.

The Model 122 also offers adjustable tractor feed, five-part forms capability and graphics resolution of 72 dots per inch vertically and 70 dots per inch horizontally.

Cost of the printer is \$1195. ■



The Centronics Model 122 graphics dot matrix printer.

pass word processing capabilities, will make the machines an attractive buy for an office with multiple printer needs.

Finally, Centronics has packed all these nice features into surprisingly small and light machines with an attractive design that fits easily on a desk.

About the only feature Centronics has not yet included is an automatic feed mechanism for cut paper. This is used extensively in heavy word processing applications where multiple copies of letters are to be printed. A firm spokesman, however, promises that such a device is just around the corner and will be offered as a future option.

Centronics is planning world-wide distribution of the new Printstation and is already dropping hints about another new office printer to be introduced later this year. With these and other new products announced last year, plus the new capital and expanded manufacturing capabilities, the company has every reason to anticipate a bright future, while users can look forward to better office printers. ■

Fall, 1981

Mr. Thomas Jones
1981 Printer Place
Boston, MA 16745

Dear Mr. Jones

We are pleased to demonstrate the latest advancement in dot matrix printers by Centronics, the CPS 353. The CPS 353 provides near letter quality printing at 50 cps for correspondence documents and standard 7x8 matrix printing at 200 cps for data processing environments. Other features on the Model 353 include pin addressable graphics, up to 10 character pitches, and liquid crystal display to indicate function status and selection. In addition, the Model 353 provides 96 character USASCII and 7 international character sets, plus the capability of a 96 character customer programmable character set.

The CPS 350 series is designed as a universal machine, incorporating fan-fold, cut sheet and demand document paper handling systems as well as RS232 and Centronics parallel interfaces. Also included is a power system which allows shipment of one model to satisfy foreign and domestic markets. Coupled with high reliability and low cost of ownership, the CPS 353 satisfies the most diverse price/performance requirements.

This concludes our product demonstration, and we are confident you will agree that the CPS 353 sets the performance standard for quality dot matrix printers in 1981.

Sincerely,

Centronics Data Computer Corporation

Correspondence-quality print from the Printstation 353.

Send Your Business To Europe Via Wayne Green International

You can introduce your products to the European market without leaving your office. All you need is a phone and the best advertising liaison between here and Europe—Wayne Green International. We represent four of the largest microcomputing magazines in Europe that will help you introduce and make your product known in the European market.

MICRO DIGEST

MICRO DIGEST is the newest resource for American businessmen to rely on for the best exposure overseas. The first publication of its kind, MICRO DIGEST caters to dealers, reps, OEMs and importers of micro and mini products. MD is the organ of the European Microcomputer Publishers Association (EMPA), publishers of the four largest computing magazines on the continent. MICRO DIGEST is published in English, French, German and Italian, and reaches a market of 312 million people. Make MICRO DIGEST your best ally in the European micro market.

CHIP

The German-speaking market has an exceptional sales potential. CHIP, the leading German magazine for desktop computers, will help you to make this market your own. Over 65% of the CHIP readership deals with computers in their business or profession. With its reputation for excellence and a paid circulation of 62,913*, CHIP is your direct line to the German microcomputer market.

*IVW Auditing (ABC Equivalent), 2nd quarter, 1981

MICRO & PERSONAL COMPUTER

MICRO & PERSONAL COMPUTER, the most sophisticated microcomputer magazine in the world, is the ideal media for introducing and marketing computer products in the Italian market today.

WAYNE GREEN INTERNATIONAL

The European Micro-Media Specialists
Peterborough, N.H. 03458 (603) 924-7138

To receive further information on these magazines, write or call:

Piergiorgio Saluti
Wayne Green International
Peterborough, New Hampshire 03458
(603) 924-7138





QUASAR

SALES REPORT (APR. '82)

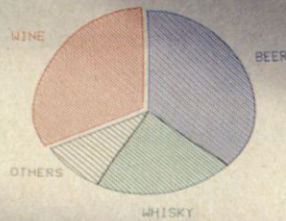

	SALES AMOUNT (DM)		INCREASING RATE (%)
	FEBRUARY	MARCH	
BEER	58,842	53,248	-5.8
WHISKY	28,633	30,723	7.3
WINE	48,980	49,151	0.5
OTHERS	14,849	14,330	2.8
TOTAL	147,638	147,444	-0.1

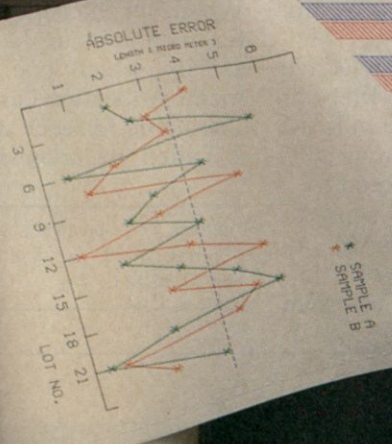
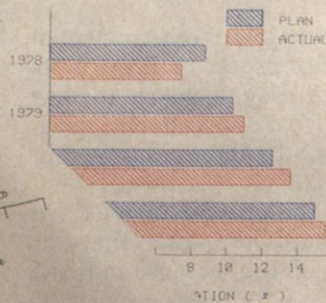

One picture is worth a thousand numbers.

Introducing the new wide-tape Quasar® 4-Color Plotter, driven by the portable with the speed and power of a desktop computer.

Coupled with the sophisticated Quasar Hand-Held Computer, this advanced, 80-character plotter turns dry statistics into dramatic graphics anytime, anywhere. Makes analysis easier, presentations more exciting.

The Quasar HHC is actually a desktop computer you can take with you. Its heart is a fast, powerful 6502 microprocessor, with powerful programming languages—Microsoft BASIC, SnapBASIC and SnapFORTH, and high-memory capacity of up to 8KB RAM and 16KB ROM internal, expandable with external Memory Modules and ROM's or EPROM's in capsules. Operates on rechargeable NiCad batteries and retains data with power off.



The Quasar mainframe has a complete range of intelligent peripherals including a new 40-Character Printer, Telephone Modem/Cassette Interface, RS232 Interface, Color TV Adaptor, I/O Adaptor that works with up to 6 peripherals.

That means the Quasar HHC system can be your personal computer and database, or portable terminal that interacts with a large, central computer, or supplementary system to host computers for data retrieval, collection and transfer.

An expanding array of snap-in software includes modelling programs for "what if" alternatives, programs for time-billing professionals, financial calculations, and many others for scientific, engineering, marketing and business applications.

For a complete information kit, write Quasar HHC Dept., or use Reader Service Card.

Quasar

Portable Computer Systems

For HHC system tailored to your specific application contact System House/OEM:

American Medical Instruments Albany, CA 415-525-1113	Cyber Diagnostic Corp. Aurora, CO 303-695-8751	Impact Technologies Group, Inc. Salisbury, NC 704-637-6183	Systems 7, Inc. Houston, TX 713-468-4394	RPC Electronics Pittsburgh, PA 412-782-3770	InterNet San Francisco, CA 415-227-4258
Insta-Data Systems, Inc. Simi Valley, CA 805-522-9629	Pentagon Industries, Inc. Chicago, IL 312-867-9200	System Exposure Dunedin, FL 813-736-5154	Agent Computer Services, Inc. Columbia City, IN 219-422-6552	Straitline Marketing Inc. New York, NY 212-445-4225	

Beyond 64K For the Apple

For all you doubting Thomases who thought the Apple was limited to 64K RAM, we give you memory to spare from Saturn Systems.

By Donald J. Black

Most owners of the 48K Apple II can accept the idea of adding 16K RAM. 64K bytes seems natural. But more than 64K seems to be hard to understand. What do you do, for instance, with Saturn Systems' 32K RAM board?

The product is, in fact, quite useful. The organization of the Apple II lends itself nicely to an extra 32K of RAM. Using it isn't as easy as upgrading memory from less than 48K. But with some clever software you can make good use of the extra memory.

One common approach is to put your disk operating system (DOS) and the "alternate" (non-ROM) Basic in the extra memory. This frees practically all of the lower 48 for user programs.

Another approach is to use the extra memory like a high-speed cassette or disk file. You can save and retrieve programs and data. This is much faster than cassette or disk (of course,

the RAM must be reloaded every time you turn off the power; it's not a permanent memory like cassette or disk).

Other specific applications have been modified to take advantage of the increased memory available. For example, there are now programs available to modify VisiCorp's VisiCalc so that you may have a larger workspace.

And there are lots of other potential uses. One nice aspect of RAM is its flexibility. It's easy to change the use of the RAM from application to application. Just load a different program, and off you go.

As usual, the answer to effective use of new hardware lies in the software. Most of the expansion RAM boards come with supporting software. Don't buy one that doesn't.

It certainly doesn't make sense to consider using expansion RAM unless you already have 48K of "normal" RAM. If you have less than

48K, it's cheaper to buy additional RAM and plug it into the Apple. For that reason, this article assumes you have 48K of "normal" RAM. The suppliers of expansion RAM boards make the same assumption. I call the extra RAM "expansion RAM" because it expands your system beyond 48K.

Addressing Memory

To understand how the expansion boards work, you need to know how a computer addresses memory. Whenever the computer wants to refer to a memory location, it must specify which one it wants. Each memory location has a unique name. The name for each memory location is called its *address*. Each address

Address correspondence to Donald J. Black, Micro Solutions, Inc., 411 Barber Ave., Ann Arbor, MI 48103.

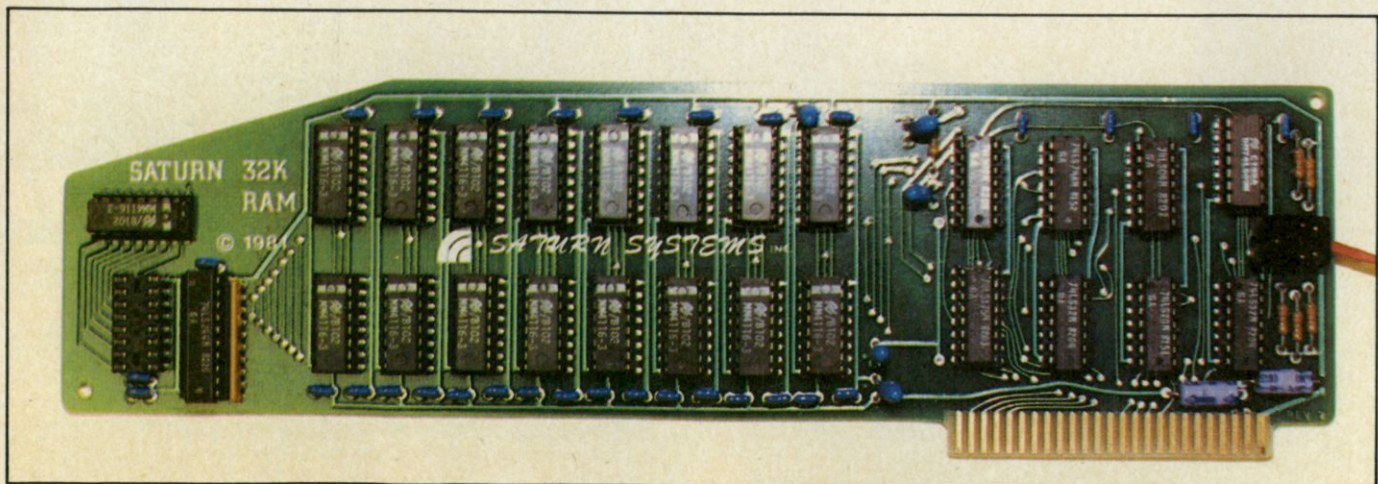

Saturn Systems' 32K RAM board.

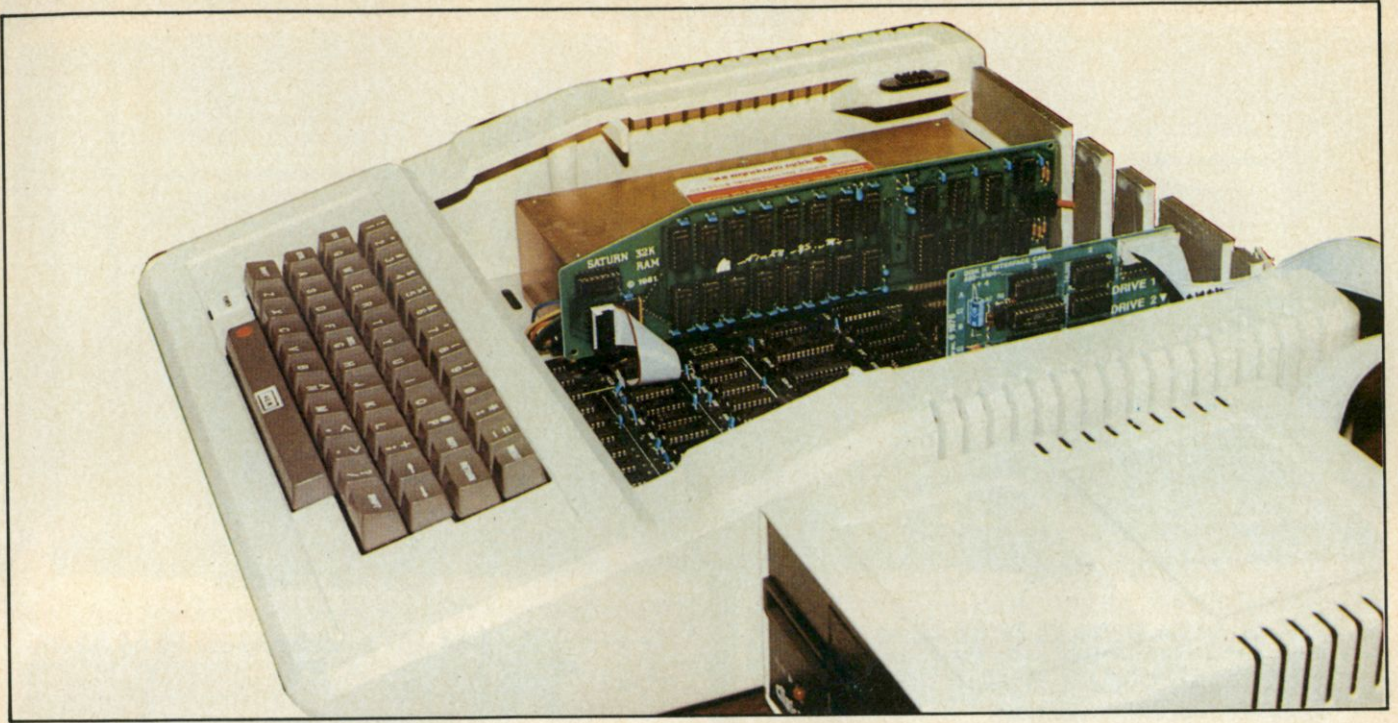

The Apple with a 32K RAM board installed.

specifies one memory location. Addresses are usually integers between zero and some upper limit. The collection of available addresses is called the *address space*.

The Apple's 8-bit 6502 microprocessor can specify 65,536 different addresses. Thus, at any time it can address one of 64K different memory locations. The addresses are integers between zero and 65,535. Since programs running on an Apple can address all 64K locations, the address space for any program running on an Apple is the same 64K. (Note that not all of those addresses are necessarily meaningful. If you have less than 48K

RAM, your program can look for locations for which there is no memory. If you do this, results are unpredictable.)

The normal Apple memory organization provides 48K addresses for RAM, 4K addresses for I/O and 12K addresses for ROM. Addresses from 0 through 49,151 (0 through BFFF hexadecimal) are normally RAM. 49,152 through 53,247 (C000 through CFFF) are used for I/O. 53,248 through 65,535 (D000 through FFFF) are normally ROM.

This organization provides a use for all of the address space. This is, of course, reasonable. It means, how-

ever, that any additional memory must share the same address space. In other words, to access memory on the expansion board, you must turn off some other memory. The I/O portion of the address space is not a viable candidate. For one thing, I/O references are used to turn the expansion memory on and off. Furthermore, programs in the expansion memory might want to do I/O. This leaves the RAM and ROM portions of the address space for potential sharing. The Apple bus structure provides for disabling the normal ROMs. Thus, the ROM portion of the address space is the common choice for

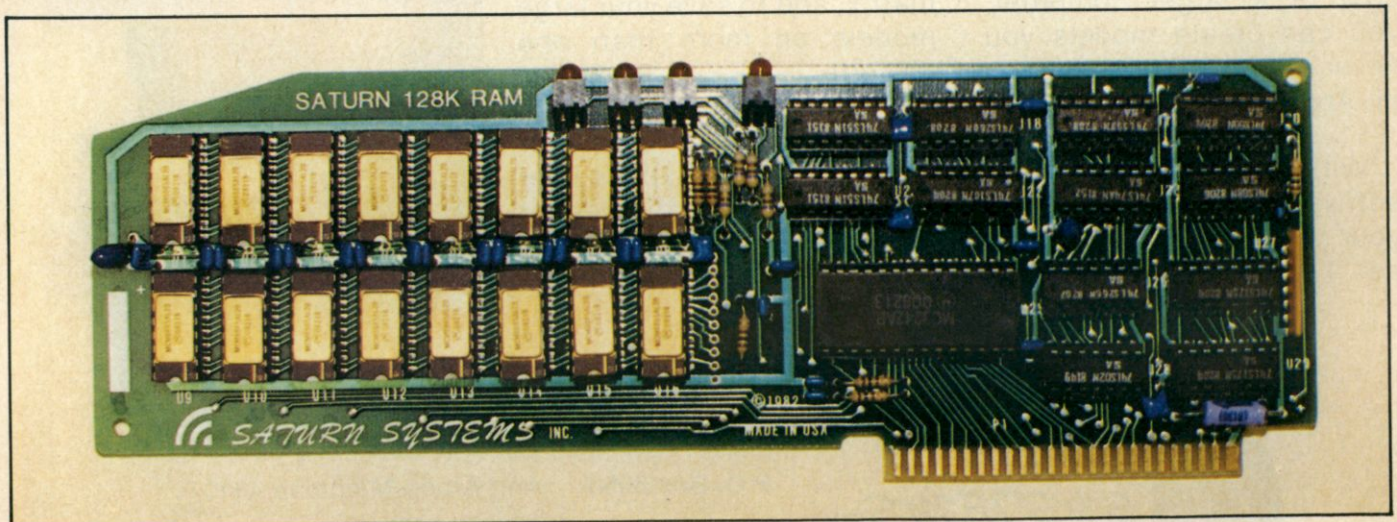

128K RAM board. The 64K board is identical; it is a half-populated 128K board.

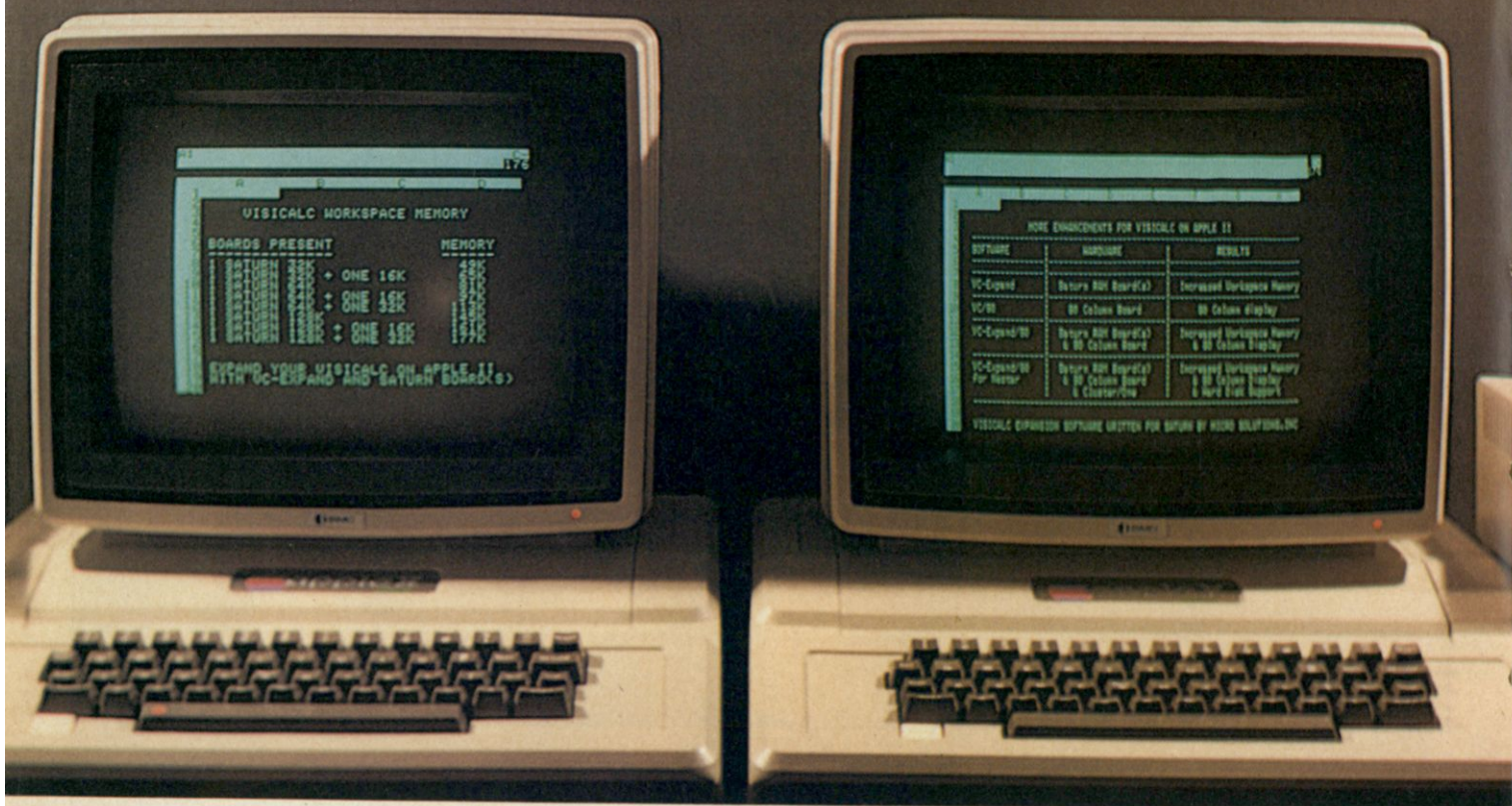

EXPAND VISICALC® ON APPLE® II

Do you need more memory for your VisiCalc models? Would you like to see them in 80 column display? Do you want hard disk support?

Then you need one of Saturn's VisiCalc expansion systems. For a fraction of the cost of a larger computer, you can create models you never dreamed possible on an Apple II.

With Saturn board(s) and software, you can increase your workspace to as much as 177K. With additional

hardware, you can get 80 column display and lower case letters. You can even use the Nestar hard disk system, if you wish.

Saturn's VC-Expand programs allow you to use the entire displayed VisiCalc matrix, and to save your large models on more than one diskette.

You can also use your Saturn boards to expand user programming capabilities, or to simulate a disk drive under DOS, PASCAL, or CP/M.®

Ask your retail computer store salesperson about Saturn's memory expansion systems. See how much bigger and better your VisiCalc models can become.



VisiCalc is a registered trademark of VisiCorp.
 Apple is a registered trademark of Apple Computer, Inc.
 CP/M is a registered trademark of Digital Research Corporation.

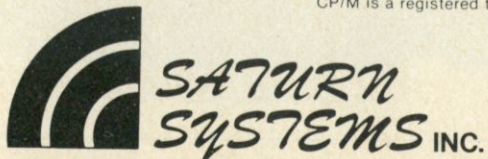

P.O. Box 8050 Ann Arbor, Michigan 48107
 (313) 973-8422

A 32K card with your alternate Basic and DOS would justify the price without other applications. But this is only the beginning.

sharing with expansion memory. When the expansion memory is enabled, the ROM area is disabled (although there is a middle ground, which I will discuss later).

Sharing the ROM area probably makes the most sense from the programmer's point of view. That makes the maximum amount of RAM available when the expansion memory is enabled. It also means the expansion memory can simulate such firmware cards as Applesoft or Integer Basic.

Since the expansion RAM cards are larger (have more memory) than the ROM area available for sharing, not all of the expansion memory can be enabled at one time. Most expansion RAM cards use 16K- by 1-bit RAM chips for the actual memory. Multiples of eight chips (for 8-bit bytes) provide multiples of 16K-byte blocks of memory. (Some cards are coming on the market using 64K- by 1-bit memory chips. These will provide multiples of 64K-byte blocks of memory.) The ROM area is only 12K bytes, however. Only 12K of expansion RAM can be enabled at any time.

To accommodate this, the expansion memory cards have the following organization. The memory is divided into 16K blocks. Each 16K block is further divided into an 8K bank and two 4K banks.

As mentioned above, the expansion memory is selected by making memory references to the appropriate addresses in the I/O portion of the address space. The exact addresses depend on the slot containing the card. Naturally, the memory reference instruction to disable a bank cannot be in the bank itself. If it were, the bank would be disabled for the instruction following the memory reference. The next instruction would come from ROM or some other bank. There is a very small chance that this arrangement would be useful. In any case, it would be poor programming practice. Clearly you can't enable a bank with instructions in that bank. If the

bank is not enabled, you can't access the bank to execute the instructions.

Only one bank should be enabled at any time. To switch from one bank to another, you should disable the first bank before you enable the second. This means you shouldn't enable one bank with instructions in another bank. (Note, though, that if your program is in the 8K bank, it can switch 4K banks as desired.)

This means that using the expansion memory requires some support code in the lower RAM area. You at least need instructions to enable or disable the desired banks. Basic programs require machine-language subroutines to switch between Basic (in ROM or expansion memory) and expansion memory. Basic programs probably need other machine-language subroutines to use the expansion memory, too.

A number of uses for expansion memory spring to mind. First, of course, it can simulate the firmware cards or language card. You can have both Integer Basic and Applesoft in the ROM area of the address space. Switching from ROM Basic to the alternate Basic becomes much faster. Also, you don't lose the RAM space for the alternate Basic. This would be useful if you use both Basics.

To enable expansion memory, you select one of the 16K blocks. The 8K bank and one of the 4K banks are enabled. You may select either 4K bank. You may not enable both 4K banks at the same time. With a 32K card, there are four possible combinations of banks which can be enabled. There are two 8K banks, and each 8K bank has two corresponding 4K banks.

What It Means to You

The 16K blocks are independent of each other. Within a 16K block, either 4K bank can be enabled with the 8K bank. Usually, though, you will consider that you have a 12K bank and a 4K bank.

For each selection of banks, there are four possible settings. Both RAM read and RAM write may be on or off. The four settings are:

1. RAM read on, RAM write on
2. RAM read on, RAM write off
3. RAM read off, RAM write on
4. RAM read off, RAM write off

Case 1 is a normal setting for using the expansion memory as RAM. Case 2 simulates a ROM. Once the RAM is loaded (using a RAM write setting), the RAM can be write-protected.

Circle 169 on Reader Service card.

Dealers welcome!

ELCOMP

BOOKS
and SOFTWARE

For ATARI-PET-OSI-APPLE II-6502-VIC-20-Sinclair-Timax

ATARI ATARI ATARI ATARI

ATARI BASIC - Learning by Using
This new book is an "Action" Book. You do more than read it. Learn the intricacy of ATARI-BASIC through the short programs which are provided. The suggestions challenge you to change and write program routines. Yes, it's exciting!
Many of the programs are appropriate for beginners as well as experienced computer users. (Screen Drawings, Special Sounds, Keys, Paddles + Joysticks, Specialized Screen Routines, Graphics and Sound, Peeks and Pokes and special stuff.)
Order-No. 164 \$9.95

ATARI Learning by Using - Book + cassette or disk
This package includes the book No. 164 plus a cassette or disk (please specify) containing a variety of the programs which are listed in the book.
Order-No. 7220 \$39.95

Games for the ATARI-Computer
How to program your own games on the ATARI. Complete listings in BASIC and Machine Language of exciting games. Tricks and hints.
Order-No. 162 \$7.95

GAME PACKAGE for the ATARI
Book + cassette or disk
Includes the book No. 162 plus cassette or disk (please specify) containing a variety of the programs listed in the book.
Order-No. 7221 \$39.95

ATMONA-1
Machine Language Monitor for the ATARI 400/800.
This powerful monitor provides you with the firmware support that you need to get the most out of your powerful system. ATMONA-1 comes on a bootable cassette. No cartridges required. Disassemble, Memory Dump HEX + ASCII, (Change Memory Locations, Blocktransfer, fill memory block, save and load machine language programs, start mach. Lang Progr. (Printer optional).
Comes with introductory article on how to program the ATARI computer in machine language. (Available also in ROM)
Order-No. 7022 \$19.95

ATMONA-2 Superstepper
A very powerful Tracer to explore the ATARI ROM/RAM area. Stop at previously selected address. Operate on standard (cassette).
Order-No. 7049 \$49.95

EDITOR/ASSEMBLER for ATARI 800, 12K or 48K RAM
Extremely fast and powerful Editor/Assembler (8K Source code in about 1/2 minutes) Includes ATMONA-1
Order-No. 7098 \$49.95

MACRO Assembler for ATARI 800, 48K RAM
Please specify your system RAM, disc or cassette.
Order-No. 7099 \$89.00
Add \$39.00 for cartridge version

GunLight for ATARI 400/800
16K RAM, needs two joysticks, animation and sound (8K machine language)
Order-No. 7207 \$19.95

Birth control with the ATARI (Klaus Oigin) Cass or disk
Order-No. 7222 \$29.95

Astrology and Biorhythm for ATARI (cass. or disk)
Order-No. 7223 \$29.95

EPROM Cartridge KIT for ATARI
Cartridge (bare board) with instructions (holds two 16K or two 32K EPROMs (2716, 2732, 2732)
Order-No. 7224 \$19.95
Order-No. 7043 complete \$29.95

Invoice Writing for small business with ATARI 400/800 16K RAM.
Order-No. 7022, cass. \$29.85
Order-No. 7200, disc. \$39.99

Mailing List No. 7213 \$24.95
Inventory Contr. No. 7215 \$24.95

NEW IATEX-1
This new wordprocessor in machine language (8K) for all ATARI 400/800 computers offers the best price performance ever. 23 editor control commands, 17 formatting commands, dynamic formatting. Vertical and horizontal scrolling up to 255 char per line! Include command on disk!
Order-No. 7210 cassette \$29.95
Order-No. 7211 disk \$39.95
Order-No. 7212 cartridge \$79.00

Learn FORTH for the ATARI 400/800, cassette or disk
Order-No. 7053 \$19.95

**ELCOMP Publishing, Inc., 53 Redrock Lane
Pomona, CA 91766, Phone: (714) 623 8314**

Payment: Check, Money Order, VISA, MasterCard, Eurocheck, POSTPAID on PREPAID in USA. \$5.00 handling fee for C.O.D. All orders outside USA: Add 15% shipping. CA add 6.5% sales tax. ATARI is a registered trademark of ATARI Inc. APPLE is a registered trademark of APPLE Inc. PET+VIC-20 is a trademark of Commodore.

ELCOMP FORTH - Enhanced FIG-FORTH on disk only.
Order-No. 7055 \$39.95

How to connect your EPSON Printer to the ATARI 400/800.
Construction article with printed circuit board and software. (Screenprint and variable characters per line).
Order-No. 7210 \$19.95

OSI OSI OSI OSI OSI

The First Book of Ohio Scientific
Introduction to OSI computers. Diagrams, hardware and software information not previously available in one compact source. 192 pages.
Order-No. 157 \$7.95

The Second Book of OHIO
Order-No. 158 \$7.95

The Third Book of OHIO
Order-No. 159 \$7.95

The Fourth Book of OHIO
Order-No. 160 \$9.95

VIP Package - Above book plus a cassette with the programs.
Order-No. 160A \$19.95

The Fifth Book of OHIO
Order-No. 161 \$7.95

Invoice Writing Program for OSI: C1PMF, C4P, Disk and Cassette, 8K RAM.
Order-No. 8234 \$29.80

Mailing List for C1PMF or C4PMF 24K RAM
250 addresses incl. phone number and parameters on one 1/4 disk!
Order-No. 8240 \$29.80

8K Microsoft BASIC Ref. Man.
Order-No. 151 \$9.95

Expansion Handbook for 6502 and 6802
Order-No. 152 \$9.95

Microcomputer Appl. Notes
Order-No. 153 \$9.95

Complex Sound Generation
New revised applications manual for the Texas Instruments SN 76477 Complex Sound Generator.
Order-No. 154 \$6.95

Small Business Programs
Complete listings for the business user. Inventory, Invoice Writing, Mailing List and much more. Introduction to Business Applications.
Order-No. 156 \$14.90

Microcomputer Hardware Handbook (845 pages)
Descriptions, pinouts and specifications of the most popular microprocessor and support chips. A MUST for the hardware buff.
Order-No. 29 \$14.95

Care and Feeding of the Commodore PET
Eight chapters exploring PET hardware. Includes repair and interfacing information. Pro gramming tricks and schematics.
Order-No. 150 \$9.95

Prototype-Expansion Board for VIC-20 (S-44-Bus).
Order-No. 4844 \$18.95

Wordprocessor (VIC-20, 8K RAM)
Order-No. 4870 \$19.95
Mailing List for VIC-20, 16K RAM
Order-No. 4883 \$14.95

Tricks for VICs - The VICtory Programs, hints and expansion information for VIC 20
Order-No. 141 \$9.95

TIC TAC VIC
Order-No. 4880 \$9.95

GAMEPACK 1 (3 Games)
Order-No. 4881 \$14.95

Dual Joystick Instruction
Order-No. 4885 \$9.95

INPUT/OUTPUT Programming with your VIC
Order-No. 4886 \$9.95

16K RAM/ROM board for S44-bus. Any combination of RAM and ROM on one board. (S2128 or 2716)
Order-No. 613 \$39.95

Low cost expansion boards for your APPLE II. Bare board comes with extensive description and software
6522 VIA-I/O Exp.
Order-No. 605 \$39.00

2716 EPROM-Burner
Order-No. 607 \$49.00

8K EPROM/RAM Card
Order-No. 608 \$29.00

Software for SINCLAIR ZX-81 and TIMEX 1000
Machine Language Monitor
Order-No. 2399 \$9.95

Mailing List
Order-No. 2398 \$19.95

Programming in BASIC and machine language with the ZX-81(82) or TIMEX 1000.
Order-No. 140 (book) \$9.95

RS-232 PROBLEMS?

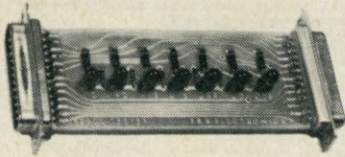

LET THE RS-232 TESTER HELP YOU SOLVE YOUR COMPUTER INTERFACE PROBLEMS. DESIGNED TO CONNECT IN SERIES WITH ANY RS-232 INTERFACE, IT DISPLAYS THE STATUS OF SEVEN OF THE MOST IMPORTANT LINES: TRANSMIT DATA, RECEIVE DATA, REQUEST TO SEND, CLEAR TO SEND, DATA SET READY, CARRIER DETECT, AND DATA TERMINAL READY. THE RS-232 TESTER REQUIRES NO POWER AND MAY BE LEFT IN THE LINE PERMANENTLY.

\$39.95 POST PAID

B & B ELECTRONICS

Box 475 / MC, Mendota, IL 61342

DISK DOUBLER PROGRAM NOW AVAILABLE

"DOUBLE THE STORAGE CAPACITY OF YOUR 5 1/4" DISKETTES." NOW YOU CAN INCREASE THE SIZE OF USABLE SPACE ON YOUR 5S/SD OR 5S/DD 5 1/4" DISKETTES.

THIS PROGRAM IS DESIGNED TO DOUBLE THE STANDARD STORAGE CAPACITY ON YOUR 5S/SD OR 5S/DD 5 1/4" DISKS. ALL YOU PAY IS A ONE TIME FEE OF \$12.95. USE THE PROGRAM OVER AND OVER. AS OFTEN AS YOU LIKE. NO EXTRA FEES. THIS PROGRAM WILL WORK WITH ALMOST ALL 5S/SD OR 5S/DD DISKETTES. HURRY, SEND \$12.95 U.S., CASH, CHECK OR MONEY ORDER TO:

**DISK DOUBLE PROGRAM
CP-M Co.**

P.O. Box 1045

WOODLAND HILLS CA 91365

Nationwide: 1-800-428-7825 ext. 43

California only: 1-800-428-7824 ext. 43

California residents add 6% sales tax, Los Angeles residents add 6.5% sales tax. Please include \$1.00 Postage and Handling, all orders shipped within 10 days. Disk Doubler Program Copyrite 1982

Computer Peripheral-Materials Company.

LABELS

299

perM

15/16" x 3 1/2" white pressure
1 up - pin feed sensitive

PRICE INCLUDES SHIPPING

Packed 5M per box - Min. order 1 box - \$14.95
Check with order - Mass Residents add 5% Sales Tax



CHECK-MATE™

P.O. Box 103, Randolph, MA 02368

Telephone: 617-963-7694

CALL TOLL FREE 1-800-343-7706

Case 3 is interesting. The RAM read is off, but RAM write is on. In this situation, memory-read references will fetch data from some other source. This might be your normal ROM or another memory bank. Memory-write references do write into this bank. This setting provides a convenient way to copy data from ROM into expansion memory. You could also use this setting to copy data from one 16K block to another (you should select case 2 for the source block and case 3 for the destination).

Case 4 means the block is off. If all blocks on all cards are off, you've selected the normal ROM.

A 12K bank is also just the right size to contain a disk-operating system (DOS). With the right changes, and support software in low RAM, a DOS can be made to run in expansion memory. The support software consists mainly of code to enable and disable the appropriate banks as you enter and exit the DOS. Putting the DOS in expansion memory frees the 10.5K of low RAM normally used by the DOS. This provides a substantial increase in the size of the programs you can write. With no other special software your Basic program space just gained 10K bytes.

Both the alternate Basic and DOS use a 12K bank. Both leave a 4K bank unused. Also, if you don't use the alternate Basic, you wouldn't want to dedicate a 12K bank to it. You might also have a firmware or language card. Thus, with one 32K card, you have 8K, or possibly 20K, available for other applications. You might also consider more than one expansion memory card.

A 32K card with your alternate Basic and DOS would be quite an increase in capability. It probably would justify the price without other applications. But this is only the beginning of potential uses for expansion memory.

There are now 64K and 128K boards available from Saturn Systems. Imagine using VisiCalc with a 48K Apple II, and 32K and 128K RAM boards. This would give you 177K to work with.

The nice thing about these applications is that they require no programming by you to use the RAM boards. Most users are buying solutions, not just untamed computing power. If you want to go further, the application package from Saturn Systems may be for you.



Dysan

CORPORATION

Solve your disc problems, buy 100% surface tested Dysan diskettes. All orders shipped from stock, within 24 hours. Call toll FREE (800) 235-4137 for prices and information. Visa and Master Card accepted.

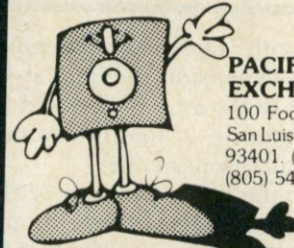

PACIFIC EXCHANGES

100 Foothill Blvd.
San Luis Obispo, CA
93401. (In Cal. call
(805) 543-1037.)



Free

Microprocessor Catalog

40 page catalog of 6800 single board computers, interface modules, SPRINT 68 control computer, development system, WIZRD multitasking DOS, assemblers, compilers, BASIC, cross assemblers, cross compilers, custom engineering, OEM applications software.



Wintek Corp.
1801 South Street
Lafayette, IN 47904
317-742-8428

BACK ISSUES

KM3006—Single back issue
before July 1980. \$3.00
KM3507—Single back issue
July 1980 on. \$3.50
KM0005—5 your choice. . . \$10.75
Add \$1.00 per magazine for shipping.

KM0010-10 your choice. . . \$16.00
KM0025-25 your choice. . . \$27.00
KM1025-25 our choice. . . \$14.00
Add \$7.50 per order for shipping.

●FREE BACK ISSUE CATALOGS are yours for the asking. . . specify 73 Magazine, and/or Microcomputing, back issue catalog when you send your name and address to us on a postcard.

Back Issues ● Attn. Pauline Johnstone
80 Pine St. ● Peterborough, NH 03458

Circle 70 on Reader Service card.

AD-3 REAL-WORLD APPLE[®] INTERFACE CARD



• A/D Conversions—3 DC, 1 AC port!
 • D/A Conversions—Direct or Filtered!
 • 16 User-Defineable I/O Ports!
 • 2 Multi-Mode Timers—Interrupt Capability!
INCLUDES: Board, Manual, Ribbon Cables, & Demo Diskette. Included diskette requires DOS 3.3, 48K, Applesoft firmware. A knowledge of machine language will enhance your use of this product.
INTRO PRICE: \$99 Add \$4 for Postage and Handling. Ohio residents add 6% Sales Tax. Apple and Applesoft are registered trademarks of Apple Computer.

FAXSCAN INC.
 3148 Dorf Drive • Dayton, Ohio 45418

Circle 111 on Reader Service card.

IS YOUR North Star OUT OF SORTS?

INCREASE YOUR BASIC'S SORTING POWER OVER 1800%! N*SORT

is easy to use and will perform sorts on one and two dimensional or string arrays using optional sort keys. For example, to alphabetize A\$:

10 A\$ = "ZYXWVUTS" \ REM Define String
 20 SRT A\$.LEN(A\$) \ REM Sort A\$

N*SORT interfaces to any release 4 or later North Star Basic and can be yours for **ONLY \$89** plus \$1.50 shipping

Calif. Res. add 6% tax.
 Send check VISA or M/C
 Complete Brochure Available

SZ Software Systems

1269 Rubio Vista Road, Altadena, Calif. 91001
 (213) 791-3202

Circle 303 on Reader Service card.

Best Prices!

hp HEWLETT PACKARD
HP-41CV, \$237
HP-41C, \$189



HP-41 CARD READER \$165
 HP-41 OPTICAL WAND 99
 HP-41 PRINTER (82143A) 289
 HP-IL INTERFACE MODULE 95
 HP-IL PRINTER (82162A) 375
 HP-IL DIGITAL CASSETTE DRIVE 419
 HP-IL VIDEO INTERFACE CALL
 HP-41 EXT. FUNC. MEMORY MOD. 62
 HP-41 EXT. MEMORY MODULE 62
 HP-41 TIME MODULE 62

HP-12] **\$115**
 HP-15] *Your Choice*
 HP-16]

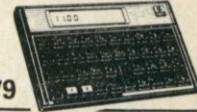

HP-11C . . . \$79

IBM QUADBOARDS BY QUADRAM, CORP.

MEMORY EXPANSION /CLOCK /PARALLEL INTERFACE /RS232 INT. *ON ONE BOARD!*
 QUADBOARD w/64K INSTALLED . . . \$495
 QUAD BOARD w/256 K INSTALLED . . . \$795

Circle 120 on Reader Service card.

TRS-80[®] ATARI Home Computer

Includes a FREE Green Screen, a \$22.95 Value!



MODEL III 16K **\$825** MODEL 400 16K **\$275**
 Model III 48K **\$1,999** Model 800 48K **\$779**

Price — We have the best price. Check the others, but call us.

Selection — ATARI • APPLE • TRS-80 • EPSON • OKIDATA • C. ITOH, etc.

Service — Most items in stock for immediate shipment. Call or write for Free 40 page catalog of over 600 items.

Computer Discount of America

15 Marshall Hill Road
 West Milford Mall
 West Milford, NJ
 07480-2198
 In New Jersey call
 201-728-8080

CALL TOLL FREE: 800-526-5313

Circle 233 on Reader Service card.

NEW 23K PERSONAL COMPUTER
\$239.00 FACTORY SALE PRICE

You get the NEW APF IM-1 Full Size Powerful Computer: Includes 14K ROM with Level II BASIC built in, 9K user RAM, Color, Sound, Professional 53 keyboard, two controllers, two 10 key numeric pads, high speed cassette, AC adapter, RF Modulator, TV switchbox. Accepts TAPE-DISK-PLUG IN CARTRIDGES. It is PLUG IN EXPANDABLE. 90 day parts and labor warranty, owners quick, BASIC language manual. All this in a beautiful black and white console case for only \$239.00.

15 DAY FREE TRIAL Return within 15 days complete and undamaged for refund of purchase price.

PROTECTO ENTERPRISES
 BOX 550, BARRINGTON, IL 60010
 TO ORDER PHONE 312/382-2192



ATARI 800 \$649
ATARI 400, \$259

ATARI 810 DISK DRIVE
 ATARI 410 PROGRAM RECORDER 79
 ATARI 16K MEMORY MODULE 75
 ATARI 825, 80 COLUMN PRINTER 565
 ATARI 850 INTERFACE 159



Texas Instruments
TI-99/4, \$298

TI-58C \$79 TI-59C \$169
 TI-55 II 36 TI-LCD PROGMR..55
 TI-PC-100C PRINTER/PLOTTER \$149

commodore
VIC20.. \$239

VIC-20 DATASETTE \$67
 VIC 1515 PRINTER 339
 VIC MODEM 89
 VIC SUPER EXPANDER 59

NEC PC-8001 COMPUTER ... \$749
 PC-8031 DUAL DISK ... 749
 PC-8023 PRINTER 499

SHARP

PC-1500 POCKET COMPUTER ... \$219
 CE-150 FOUR-COLOR PRINTER ... 185

APPLE II 48K ... Call
 APPLE III 128K ... Call
 MICROSOFT 16K RAM (for APPLE) 145

MICROSOFT PREMIUM SYSTEM (for APPLE) .. 599
 AMDEK 13" COLOR MONITOR 349
 ZENITH 121 GREEN PHOS. MONITOR ... 119

NEW SMITH-CORONA DAISYWHEEL PRINTER, TP-1...\$649

Personal (315) 478-6800
PCS Computer Systems
 All prices are subject to change without notice.

Prices do not include shipping

P.O. Box 1073
 Syracuse, N.Y. 13201

Circle 234 on Reader Service card.

VIDEO OUTPUT for H/Z '19 or '89



Display the CRT image on Projection TV or other monitor. Great for classroom or group applications.

Only **\$79.00**
MAGNOLIA MICROSYSTEMS

2264 - 15th AVE. W • SEATTLE, WA 98119
 (206) 285-7266 (800) 426-2841

ATTENTION !!

Foreign Computer Stores/ Magazine Dealers

You have a large technical audience that speaks English and is in need of the kind of microcomputer information the Wayne Green Publications group provides.

Provide your audience with the magazines they need and make money at the same time. For details on selling Microcomputing, 80 Micro, Desktop Computing and Wayne Green Books contact:

Sandra Joseph
World Wide Media
386 Park Ave. South
New York, N.Y. 10016
Phone—(212) 686-1520
Telex—620430

YOU CAN PAY MORE BUT YOU CAN'T GET MORE!



Color Computer 16K
\$305 w/16K Ext. Basic
\$399 w/32K Ext. Basic
\$499

Model III 16K **\$799**
 Model III 48K 2 disk & RS232 c **\$1949**

BUY DIRECT. These are just a few of our great offers which include Printers, Modems, Computers, Peripherals, Disc Drives, Software and more. **call TOLL FREE 1-800-343-8124**

We have the lowest possible fully warranted prices and a full complement of Radio Shack Software.

computer plus

Write for your free catalog.
 245A Great Road
 Littleton, MA 01460
 617 • 486 • 3193



Circle 279 on Reader Service card.

fullFORTH+
for
APPLE/PET

Full implementation of FIG FORTH PLUS

6502 CONDITIONAL ASSEMBLER
 INTEGER AND FLOATING POINT ARITHMETIC
 STRING MANIPULATION WORDS
 IF-DO (A form of CASE statement)
 CURSOR CONTROL SCREEN EDITOR
 SINGLE AND MULTI DIMENSIONAL ARRAYS
 DISK VIRTUAL MEMORY
 ADDITIONAL UTILITIES INCLUDING:
 SCREEN TO SCREEN COPY
 CORE DUMP
 PRINTER CONTROL WORDS
 FORTH WORD DECOMPILER
 TARGET COMPILER NOW AVAILABLE
 COMPLETE DOCUMENTATION INCLUDES:
 INSTALLATION GUIDE (8 PAGES)
 GETTING STARTED (TUTORIAL) (28 PAGES)
 USERS GUIDE (86 PAGES)

Purchasers receive 1 year subscription to the fullFORTH+ Newsletter (Published bi-monthly)
 Price \$100.00—foreign \$110.00 (Add \$2.50 shipping) (PA residents add 6% sales tax)

IDPC CO. — Box 11594, Phila., Pa. 19116
 or call — (215) 676-3235

Circle 71 on Reader Service card.

— Professional —
REAL ESTATE SOFTWARE
 for APPLE, TRS-80 & CPM SYSTEMS

- **PROPERTY MANAGEMENT SYSTEM: \$375**
 - Tenant History
 - Late Rent Report
 - Vacancy Report
 - Income Report
 - Auto Late Charge
 - Returned Checks
 - Operating Stmt
 - Building Reports
 - Utilities Report
 - Tax Expense Report
 - Prints Checks
 - Prints Receipts
- **PROPERTY LISTINGS/COMPARABLES: \$325**
 — SCREEN BY —
 - Max/Min Price
 - Units/Zone/City
 - Max Price/Income
 - Max Price/Sq Foot
 - Min Cashflow
 - 22 Items/Listing
 - 1000 Listing/Disk
 - Listing Memo Field
- **REAL ESTATE ANALYSIS MODULES: \$50/Module**
 - Home Purchase
 - Income Prop Analysis
 - Property Sales
 - Construction Cost/Profit
 - Tax Deferred Exchange
 - APR Loan Analysis
 - Loan Amortization
 - Depreciation/ACRS Analysis
- **WORD PROCESSOR — MAGIC WAND: \$285**

software realty company

AI Computer Stores Everywhere
 or Order COD Direct
 Cal Residents add 6% Sales Tax
 (213) 372-9419

Suite E, 1116-8th Street, Manhattan Beach, CA 90266

An Application Package

Saturn Systems Inc. (3940 Trade Center Drive, Ann Arbor, MI 48104) offers an application package to take advantage of the additional expansion memory. This package consists of a set of subroutines callable from either Integer Basic or Applesoft. The subroutines provide storage and retrieval of information in expansion memory. In a sense, the subroutines let you create and access temporary files. The files can be accessed much faster than disk files, however.

The primary functions provided are:

- Store a program in expansion memory
- Fetch a program from expansion memory and run it (this provides chaining)
- Store a portion of a program in expansion memory
- Fetch a portion of a program (this provides overlaying)
- Store an array in expansion memory
- Fetch an array from expansion memory
- Exchange an array between low RAM and expansion memory

There are other support functions such as deleting files. The package takes care of keeping track of available space. It allocates space for new files. It finds existing files when requested. The package will use as many banks in as many cards as you wish.

With this package you can put frequently-used programs in expansion memory. Then you can load them for execution much faster than from disk. In a menu-driven system, this can be quite useful. You can also do your own overlaying within a single large program. If you have large volumes of data, you can effectively increase the amount of data kept in memory.

Conclusion

The RAM cards provide an interesting example of our ability to exceed presumed limits. A lot of people thought an Apple couldn't have more than 48K RAM. They thought an Apple certainly couldn't have more than 64K RAM (the Apple is limited to a 64K address space, after all). But here we are with 80K, 96K and 112K (thanks in part to some foresight by the Apple designers). The 64K and 128K cards are now available. And beyond that, who knows? ■

CHIPS & DALE
 Specializing in memory Chips

THE INFLATION FIGHTERS!

Please note: software now available for CPM® and other select computers such as Apple® and Pet®.

- Z80A CPU \$4.50**
- 8251A \$4.00**
- 1791 Controller \$16.50**
- 1771 Controller \$15.00**
—RAM—
- 4116 300 ns 8/\$11.00**
- 4116 250 ns 8/\$12.00**
- 4116 200ns 8/\$12.50**
- 4116 150ns 8/\$14.50**
- 2114L 300ns 8/\$15.00**
- 2114L 200ns 8/\$16.50**
- 4164 200ns \$7.90**
- 4164 150ns call**
- 6116 2K-8 BIT 150ns \$7.75**
- 6116 200ns \$5.75**
— EPROM —
- 2716 (5v)450ns 8/ \$3.75 ea. \$4.00 ea.**
- 2716-1 (5v)350ns 8/ \$5.50 \$6.25 ea.**
- 2732 (5v)450ns 8/ \$7.25 ea. \$9.00**
- 2532 (5v)450ns 8/ \$7.25 ea. \$9.00**
- 2764 (5v) 300ns 28 pin \$20.00 ea.**

NEW Products Coming

Very Low Prices

- Printers—Epson, Okidata, Paper Tiger & others
 - Terminals—Televideo's, Z-19's, Z-89's & others
- Please call or write for other computer peripherals

Call for quantity pricing

Call or write for Catalog
 Please allow up to 3 wks. for

Personal checks to clear
 Master charge
 VISA accepted.

Add \$3.50 Shipping & Handling
 Wash. residents add 6.6% Sales Tax
 Prices subject to change without notice

CHIPS & DALE
10655 N.E. 4th St.
Suite 400
Bellevue, WA 98004
1-206-451-9770

CHIPS & DALE
 Specializing in memory Chips

the four screws that go into the recessed bottom holes in the base of the computer.

The tape recorder is mounted in the same way except that the top of the recorder never comes off completely. Just lay the top off to the side. As a precaution, when you screw the rear of the base into the wood, cover the top of the screws with two layers of electrical tape so the wires won't touch them. If you have a disk drive instead of a cassette recorder, it can probably be mounted the same way.

Another method of mounting is to epoxy large Velcro strips on the board and its components. You should roughen up the surfaces so the epoxy will hold a little better. This mounting technique is not as secure, but it does make it easier to remove the units. I mounted the joysticks this way.

In order to mount the power transformer, screw a closed eyehook into the board, on each side of the transformer. Then attach two cable ties or string into the eyehooks over the transformer.

I spliced the transformer and recorder line cords together to a ten-foot line cord, then enclosed the

splices in a plastic box filled with silicon sealant to make it kid-proof. You could also use an extension cord with two or more sockets. Place the socket side into a plastic box, plug the other cords into it and cover the box. When you're finished you can

wrap the video and power cords around the computer for storage. You may also want to place a handle on one or more sides of the board for easy carrying. Mounting rubber feed on the bottom of the board will protect whatever it rests on. ■

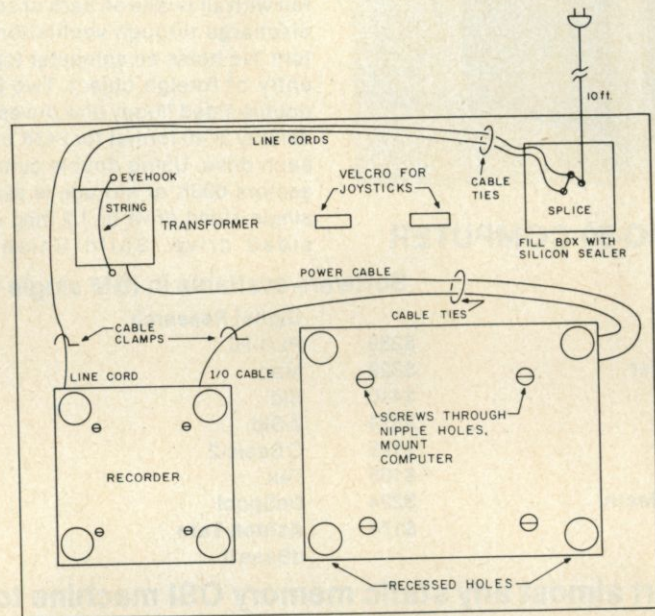
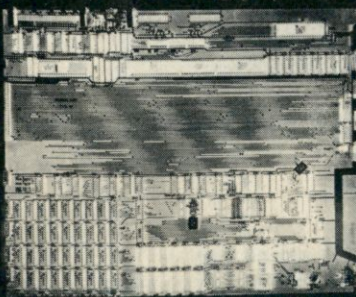

Fig. 1. The diagram shows placement of components on the board, and where to drill access holes.

Circle 133 on Reader Service card.

"THE BETTER BOARD" SB-80 Single Board Computer



**Z-80-A
64K RAM**
Fully Assembled and Tested

Size: 16" x 13"
Same as 2 8" floppy drives. Requires:
+5V 1.5 Amp
-5V 1.0 Amp
+12V 1.5 Amp

\$695.00**

CONSTRUCTION

- Sockets for all integrated circuits.
- 50 pin connector allows access to system for future expansion.

PROCESSOR

- Z80A with 4 MHz system clock with no wait states.

MEMORY

- 64K of 200ns dynamic RAM is standard. 4116 IC's
- Parity protection is standard.

ROM

- 256 bytes bootstrap ROM

2 PARALLEL I/O's 2 SERIAL I/O's COUNTER TIMERS FLOPPY DISK CONTROLLER

OPTIONS:

- Character video board 80 x 24 for use with black and white monitor using a stand alone keyboard \$215.00
- Winchester Host Adapter board for Shugart SA-1000 or Corvus Hard Disk. Includes cables \$315.00
- Stand alone keyboard and cable plugs into computer board for 80 x 24 video option \$190.00



18" W x 19" L x 8" H

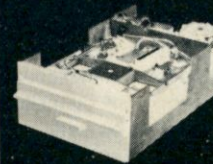

CPU — DISK DRIVE CABINET ACCOMMODATES:

- SB-80
- BRI 2000
- DIGITAL RESEARCH "The Big Board"
- OTHER SINGLE BOARDS

Metal cabinet with proportionately balanced air flow-convection cooling. AC power cord connector; lighted power switch; Fuse assembly; 0L65 Dual drive power supply (Will also power single board CPU). All hardware included to mount 2.8" disk drives. Includes space area to mount any single board computer. Fully assembled and tested.

SB — Cabinet Kit \$645.00
SB — Bare Cabinet \$135.00

\$/DD DISK DRIVE SYSTEM

SB Assembled tested with 2.8" drives \$1425.00

DD/DD DISK DRIVE SYSTEM

SB Assembled tested with 2.8" drives \$1850.00

8" FLOPPY DISK DRIVES

Single Sided/Double Density Double Sided/
Double Density
Shugart 800/801R \$390.00, 2/\$770.00
Shugart 850/851R \$560.00, 2/\$1100.00

CP/M* 2.2 & BIOS

CP/M* 2.2 & BIOS modified by S & M systems to run on single board is available for \$200.00

HOW TO ORDER Phone orders using American Express, Visa, MasterCard, Bank wire transfer, Cashier's or Certified check, Money Order, or Personal check (allow 10 days to clear). Please add 5% for shipping, handling and insurance minimum \$500.00. Conn. residents add 7.5% sales tax. All equipment is subject to price changes and availability without notice. All equipment is new and comes complete with manufacturers warranty. Showroom prices may differ from mail-order advertisement.

* CP/M is a trademark of Digital Research Corp.
** 1 to 4 piece domestic U.S. price.



Colonial Data Services Corp.

105 Sanford Street Hamden, Conn. 06514

(203) 288-2524 • Telex: 956014

A Number Pad For Apple II Users

For people who have lots of data to enter—and only two hands to do so—this simple number pad for the Apple is a real time-saver.

By James J. King

Entering lots of numerical data from the Apple II's keyboard can be tedious and frustrating because the numerals are on the top row, and you must press the return key at the end of the number entry. Using one hand at the keyboard is troublesome because so much hand movement is required—and reset lurks nearby. If you use both hands for entering numbers, you might have trouble keeping visual contact with the data you are reading from.

A solution in Applesoft is to change

the meanings of the keys, so that in effect a number pad is created from the existing keyboard. Because I prefer to use my right hand for keeping track of the data I want to enter, I converted the left portion of the keyboard. Table 1 represents the keys I use for the number pad and their meanings.

The number pad is written as a subroutine. Disk owners might want to have the number pad captured in a text file to be executed as needed. Listing 1 has the number pad at lines

100-109. Lines 500 and on are for a program to enter data and to calculate the mean and standard deviation of that data.

Line 100 reads the ASCII values from line 101 into the array JY(J). Line 102 GETs N\$. The PRINT after the GET is necessary to provide a return not supplied by GET. Line 103 checks to see if N\$ has an ASCII value the same as one held in JY(J), and if it does, EN\$ is concatenated by STR\$(J), which is a number from 0 to 9. Line 104 supplies the decimal point, and 105 the negative sign. Line 106 checks to see if the escape key was pressed; if so, an error was made, so empty EN\$. Line 107 checks to see if the space bar was pressed; if so, the number is complete, so return to main program. Line 108 checks to see if C was pressed, which would indicate that all the numbers had been entered; if so, go to 610 to compute the results. Line 109 simply catches any other character that might have been typed. Line 570 calls the subroutine.

Until you get used to the new meanings you might consider placing masking tape on the selected keys. Of course if you frequently use special constants or operations, you could define other keys for their use. ■

Listing 1. Apple II keyboard conversion.

```
5 REM APPLESOFT EXAMPLE OF A NUMBER PAD AS A SUBROUTINE
(LINES 102-109)
10 TEXT : GOTO 500: REM SKIP OVER NUMBER PAD ROUTINE
99 REM *** NUMBER PAD ROUTINE ***
100 FOR J = 0 TO 9: READ JY(J): NEXT :RETURN :REM
INITIALIZE KEY SUBSTITUTION
101 DATA 83,49,50,51,52,81,87,69,82,65 : REM ASCII FOR
KEYS S 1 2 3 4 Q W E R A
102 VTAB 10: CALL -868:PRINT EN$;: GET N$: PRINT : REM
DISPLAY NUMBER SO FAR... "PRINT" IS TO SUPPLY "RETURN"
FOR THE "GET"
103 FOR J = 0 TO 9: IF ASC(N$) = JY(J) THEN EN$ = EN$ +
STR$(J): GOTO 102:REM IS N$ ONE OF THE CODED DIGITS?
104 NEXT :IF N$ = "D" THEN EN$ = EN$ + ".": GOTO 102:
REM "D" = "."
105 IF N$ = "F" THEN EN$ = EN$ + "-": GOTO 102: REM "F"
= "-" (NEGATIVE SIGN)
106 IF N$ = CHR$(27) THEN EN$ = "": GOTO 102: REM
CHR$(27) = "ESC" = ERROR SO EMPTY EN$
107 IF N$ = " " THEN RETURN: REM SPACE BAR = THIS
NUMBER IS COMPLETE SO BACK TO MAIN PROGRAM
108 IF N$ = "C" THEN 610: REM "C" = ALL THE NUMBERS
HAVE BEEN ENTERED
109 GOTO 102: REM A CHARACTER WAS TYPED THAT IS NOT
```

More →

*Address correspondence to Dr. James J. King,
Assoc. Prof. of Counselor Education, The Univer-
sity of Wisconsin, Platteville, WI 53818.*

NEW FROM D & N MICRO PRODUCTS, INC.

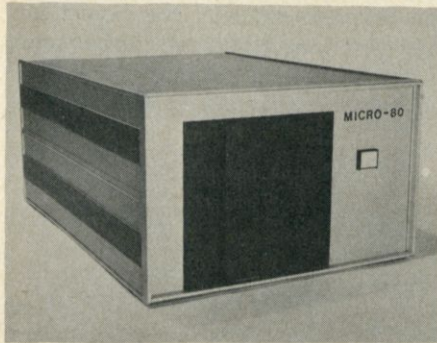

MICRO-80 COMPUTER

Z80A CPU with 4MHz clock and CP/M 2.2 operating system. 64K of low power static RAM. Calendar real time clock. Centronics type parallel printer interface. Serial interface for terminal communications, dip switch baud rates of 150 to 9600. 4" cooling fan with air intake on back of computer and discharge through ventilation in the bottom. No holes on computer top or side for entry of foreign object. Two 8" single or double sided floppy disk drives. IBM single density 3740 format for 243K of storage on each drive. Using double density with 1K sectors 608K of storage is available on a single sided drive or 1.2 meg on a double sided drive. Satin finish extruded

aluminum with vinyl woodgrain decorative finish. 8 slot backplane for expansion. 48 pin buss is compatible with most OSI boards. Uses all standard IBM format CP/M software.

Model 80-1200	\$2995
2 8" single sided drives, 1.2 meg of storage	
Model 80-2400	\$3495
2 8" double sided drives, 2.4 meg of storage	
Option 001	\$ 95
Serial printer port, dip switch baud rate settings	

Software available in IBM single density 8" format.

Microsoft

Basic-80	\$289
Basic Compiler	\$329
Fortran-80	\$410
Cobol-80	\$574
Macro-80	\$175
Edit-80	\$105
Mu Simp/Mu Math	\$224
Mu Lisp-80	\$174

Digital Research

PL/1-80	\$459
Mac	\$ 85
Sid	\$ 78
Z-Sid	\$ 95
C Basic-2	\$110
Tex	\$ 90
DeSpool	\$ 50
Ashton-Tate	
dBase II	\$595

Micropo

Wordstar	\$299
Mail-Merge	\$109
Spellstar	\$175
SuperSort I	\$195
Pascal	
Pascal/MT +	\$429
Pascal Z	\$349
Pascal M	\$355

Convert almost any static memory OSI machine to CP/M® with the D & N-80 CPU Board.

Z80A CPU with 4MHz clock. 2716 EPROM with monitor and bootstrap loader. RS-232 serial interface for terminal communications or use as a serial printer interface in a VIDEO system. Disk controller is an Intel 8272 chip to provide single or double density disk format. 243K single density or 608K double density of disk storage on a single sided 8" drive. A double sided drive provides 1.2 meg of storage. DMA used with disk controller to unload CPU during block transfers from the disk drives. Optional Centronics type parallel printer port com-

plete with 10 ft. cable. Optional Real Time Calendar Clock may be set or read using 'CALL' function in high level languages. Power requirements are only 5 volts at 1.4 amps. Available with WORDSTAR for serial terminal systems.

D & N-80 serial	\$695
D & N-80 serial w/Wordstar	\$795
D & N-80 video	\$695
Option 001	\$ 80
parallel printer and real time calendar clock	

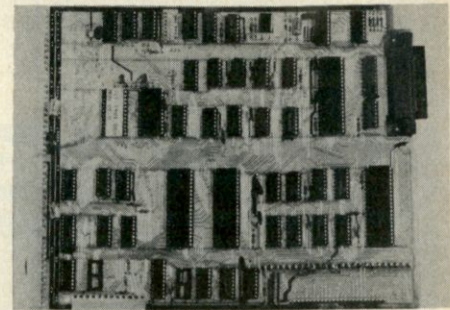

D & N-80 CPU BOARD

OTHER OSI COMPATIBLE HARDWARE

IO-CA10X Serial Printer Port \$125
Compatible with OS-65U and OS-65D software

IO-CA9 Parallel Printer Port \$175
Centronics standard parallel printer interface with 10 ft. flat cable

BP-580 8 Slot Backplane \$ 47
Assembled 8 slot backplane for OSI 48 pin buss

24MEM-CM9 \$380 **24MEM-CM9F** \$530
16MEM-CM9 \$300 **16MEM-CM9F** \$450
8MEM-CM9 \$210 **8MEM-CM9F** \$360
BMEM-CM9F \$ 50 **FL470** \$180

24K memory/floppy controller card supports up to 24K of 2114 memory chips and an OSI type floppy disk controller. Available fully assembled and tested with 8, 16, or 24K of memory, with floppy controller (F). Controller supports 2 drives. Needs separated clock and data inputs. Available Bare (BMEM-CM9F) or controller only (FL-470). Ideal way to upgrade cassette based system

C1P-EXP Expansion Interface \$ 85
Expansion for C1P 600 or 610 board to the OSI 48 pin buss. Requires one slot in backplane. Use with BP-580 backplane

BIO-1600 Bare IO card \$ 50
Supports 8K of memory, 2 16 bit parallel ports may be used as printer interfaces. 5 RS-232 serial ports, with manual and Molex connectors

DSK-SW Disk Switch \$ 29
Extends life of drive and media. Shuts off minifloppy spindle motor when system is not accessing the drive. Complete KIT and manual

Disk Drives and Cables

8" Shugart SA801 single sided	\$395
8" Shugart SA851 double sided	\$585
FLC-66ft. cable from D & N or OSI controller to 8" disk drive	\$ 69
5 1/4" MPI B51 with cable, power supply and cabinet	\$450
FLC-5 1/4 8 ft. cable for connection to 5 1/4 drive and D & N or OSI controller, with data separator and disk switch	\$ 75

Okidata Microline Printers

ML 82A Dot Matrix Printer	\$534
120 CPS, 80/120 columns, 9.5" paper width, friction or pin feed	
ML 83A Same as 82A except 16" paper width, 132/232 columns with tractor feed	\$895
ML 84 Same as 82A except 200 CPS, 16" paper width, 132/232 columns, 2K buffer, dot addressable graphics, with tractor feed	\$1152

D & N Micro Products, Inc.

3684 N. Wells St.
Fort Wayne, Ind. 46808
(219) 485-6414



TERMS \$2.50 shipping, Foreign orders add 15%.
Indiana residents add 4% sales tax.

Listing continued.

```

USED FOR THE NUMBER PAD
500 HOME: DIM EN(150): GOSUB 100
510 PRINT "ENTER UP TO 150 NUMBERS...CALCULATE      MEAN
AND STANDARD DEVIATION"
520 VTAB 3: HATB 10: PRINT "1=1 4=4 E=7 ESC=ERROR"
530 HTAB 10: PRINT "2=2 Q=5 R=8 SB=# DONE"
540 HTAB 10: PRINT "3=3 W=6 A=9 C=ALL DONE"
550 HTAB 10: PRINT "S=0 F='- ' D='.''"
555 FOR N = 1 TO 150
560 VTAB 8: CALL -868: PRINT "READY FOR # ";N
570 GOSUB 102
580 EN(N) = VAL(EN$): EN$ = ""
590 SX = SX + EN(N): X2 = X2 + EN(N) * EN(N)
600 NEXT N
610 N = N - 1:M = SX / N:D = SQR(1 / (N - 1) * (X2 / N
- M*M))
620 VTAB 15: PRINT "N=";N;" SUM X=";SX;" SUM X*X=";X2
630 PRINT "MEAN=";M
640 PRINT "SDEV=";D
650 END
    
```

Key Meaning	Key Meaning	Key Meaning	Key Meaning
1=1	Q=5	A=9	C= All numbers entered
2=2	W=6	S=0	ESC= Error
3=3	E=7	D=. (decimal point)	s-bar= Indicates end of number
4=4	R=8	F=- (negative sign)	

Table 1. Number pad equivalents the author uses.

Circle 243 on Reader Service card.

Happy Hands

Offers Discounts on All TRS-80™ COMPUTERS

We Have What You Are Looking For

- * Free Shipping Within United States
- * 26-1006 Mod III 48K \$2,055.00
- * 26-3001 4K Color 310.00
- * 26-3002 16K Color 455.00
- * 26-3003 32 K Color 520.00
- * No Tax On Out of State Shipments

For Additional Prices and
Shipping Information
Call Toll Free
1-800-545-9019

N.M. Residents Call 257-7865

or write

HAPPY HANDS
P.O. DRAWER I
RUIDOSO, NEW MEXICO
88345

80micro bookshelf Nanos System REFERENCE CARDS

For Models I, II, III, Color, Pocket and Apple II & II Plus

At last! No more flipping through the pages of the Basic manual! No more working through the maze of machine language instructions! These cards completely summarize the Basic and Assembler manuals!

FEATURES (on most cards):

memory map, eyeball graphics, math instructions, basic commands, store instructions, basic functions, load instructions, basic statements, move instructions, special keys, exchange instructions, print using examples, shift instructions, basic special characters, compare instructions, basic and assembler messages and codes, branch instructions, basic facts, data alteration instructions, reserved words, I/O instructions, ROM routines, complete character chart with graphics and space-compression codes, hex-dec chart, control code cross-reference, assembler instructions commands and operators, screen line layout, editor commands & subcommands, condition code easy access.

Model I: BASIC only FC1001	\$2.95
Model I: BASIC and Assembler FC1002	\$4.95
Model II: BASIC and Assembler FC1005	\$5.95
Model III: BASIC only FC1004	\$3.95
Model III: BASIC and Assembler FC1003	\$5.95
Color: BASIC and Extended FC1006	\$4.95
Apple II & II plus BASIC FC1007	\$3.95
Apple II & II plus BASIC & 6502 FC1008	\$4.95
Pocket: BASIC only FC1009	\$2.95



Prices do not include shipping and handling charges. Sorry no COD orders. Use the order card in this magazine to order. Allow 4-6 weeks for delivery. Shipping and handling for cards only \$1.00 per order.

80 Microcomputing Bookshelf • Peterborough, NH 03458

1-800-258-5473



*TRS-80 is a Registered Trademark of Tandy Corp.
Computer picture reprinted permission Tandy Corp.
APPLE is a registered trademark of Apple Computing Inc.



Circle 375 on Reader Service card

"Airborne Images"

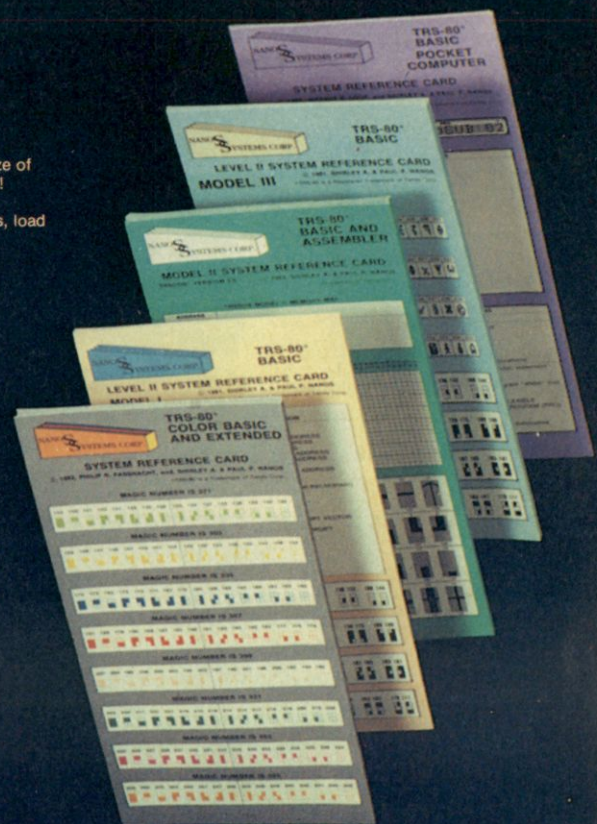

The Portable Atari

Move over, Osborne. This author has hit upon an idea that makes the Atari a little easier to carry around.

By Marvin Shuldman

I bought an Atari 400 for its superb graphics, inexpensive software, and educational value; my oldest child is only four, but computers are like ice cream to kids. When I had hooked everything up on the family room floor—computer, joysticks, tape recorder and 26-inch color TV—the picture was so beautiful I could read letters from eight feet away.

The problem was where to put our new acquisition. We had no space for a table in the room so every time I wanted to use the Atari, it would take me half an hour to drag everything out of the closet. There were two line

cords, joystick cords, the recorder cable and the transformer output plug. Putting everything on the floor in front of the TV made the room look like an engineer's nightmare, and I'd begun to dread using the Atari.

My solution was to mount everything on one board, so all I'd have to do is plug in the TV video cable, and plug one line cord into the wall.

As you can see from Photo 1, everything is neatly placed. I mounted all cables to the board with plastic cable clamps.

Layout is not critical, but you must consider electrical safety. I used a

24 × 18 × 1/2 inch formica-covered wooden board. A plywood board would work just as well.

First remove the four rubber nipples on the bottom of the computer by just pulling them out. They can be pushed back in if you don't need the board anymore, so save them. Unscrew the four recessed screws from the bottom of the computer. The top of the computer will then lift up. Unplug the keyboard gently from the bottom cable and the top will be completely free.

Temporarily place the bottom part of the computer where you would like it on the board. Using a pencil, put a mark in each one of the nipple holes. (See Fig. 1.) Also place an approximate mark near each of the recessed mounting holes.

Remove the computer, and drill four holes where the nipple marks are for mounting the base to the board. Drill a hole about 1/2 inch in diameter at each mark you made near the recessed base holes, so you can stick a screwdriver through the bottom of the board to gain access to the recessed screws whenever you want to remove the top of the computer.

Mount the computer base with a flathead machine screw through each of the four nipple holes. Carefully plug in the keyboard top and replace



Photo 1. I've mounted computer, recorder, power supply and cables firmly to the board. The joysticks attach with Velcro.

Address correspondence to Marvin Shuldman, 28 Tyndall Road, Kendall Park, NJ 08824.

ZX81



Introducing the Sinclair ZX81.

If you're ever going to buy a personal computer, now is the time to do it.

The Sinclair ZX81 is the most powerful, yet easy-to-use computer ever offered for anywhere near the price: only \$99.95* completely assembled.

Don't let the price fool you. The ZX81 has just about everything you could ask for in a personal computer.

A breakthrough in personal computers.

The ZX81 is a major advance over the original Sinclair ZX80 – the first personal computer to break the price barrier at \$200.

In fact, the ZX81's 8K extended BASIC offers features found only on computers costing two or three times as much.

Just look at what you get:

- Continuous display, including moving graphics

THE \$99.95 PERSONAL COMPUTER.

- Multi-dimensional string and numerical arrays
- Mathematical and scientific functions accurate to 8 decimal places
- Unique one-touch entry of key words like PRINT, RUN and LIST
- Automatic syntax error detection and easy editing
- Randomize function

useful for both games and serious applications

- 1K of memory expandable to 16K
- A comprehensive programming guide and operating manual

The ZX81 is also very convenient to use. It hooks up to any television set to produce a clear 32-column by 24-line display. It comes with a comprehensive programming guide and operating manual designed for both beginners and experienced computer users. And you can use a regular cassette recorder to store and recall programs by name.

Order at no risk.**

We'll give you 10 days to try out the ZX81. If you're not completely satisfied, just return it to Sinclair Research and we'll give you a full refund.

And if you have a problem with your ZX81, send it to Sinclair Research within 90 days and we'll repair or replace it at no charge.

Introducing the ZX81 kit.

If you really want to save money, and you enjoy building electronic kits, you can order the ZX81 in kit form for the incredible price of just \$79.95.* It's the same, full-featured computer, only you put it together yourself. We'll send complete, easy-to-follow instructions on how you can assemble your ZX81 in just a few hours. All you have to supply is the soldering iron.

A leader in microelectronics.

The ZX81 represents the latest technology in microelectronics. More than 10,000 are sold every week. In fact, the ZX81 is the fastest selling personal computer in the world.

We urge you to place your order for the ZX81 today.

To order.

To order, simply call toll free. Or use the coupon below. Remember, you can try it for 10 days at no risk.** The sooner you order, the sooner you can start enjoying your own computer.

Call toll free 800-543-3000.

Ask for operator #509.
In Ohio call: 800-582-1364;
in Canada call: 513-729-4300.
Ask for operator #509. Phones open 24 hours a day, 7 days a week. Have your MasterCard or VISA ready.

These numbers are for orders only. If you just want information, please write: Sinclair Research Ltd., 2 Sinclair Plaza, Nashua, NH 03061.

*Plus shipping and handling. Price includes connectors for TV and cassette, AC adaptor, and FREE manual.

**Does not apply to ZX81 kits.

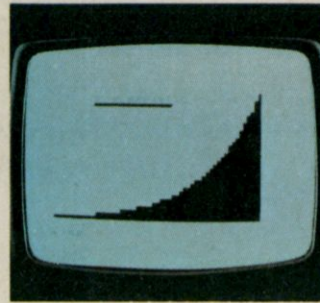

NEW SOFTWARE: Sinclair has published pre-recorded programs on cassettes for your ZX81. We're constantly coming out with new programs, so we'll send you our latest software catalog with your computer.



16K MEMORY MODULE: Like any powerful, full fledged computer, the ZX81 is expandable. Sinclair's 16K memory module plugs right onto the back of your ZX81. Cost is \$49.95, plus shipping and handling.

sinclair

To order call toll free: 800-543-3000

Ad Code	09KM	Price*	Qty.	Amount
ZX81		\$99.95		
ZX81 Kit		79.95		
16K Memory Module		49.95		
Shipping and Handling		4.95		\$4.95
TOTAL				

MAIL TO: Sinclair Research Ltd.,
One Sinclair Plaza, Nashua, NH 03061.

Name _____

Address _____

City _____ State _____ Zip _____

*U.S. dollars

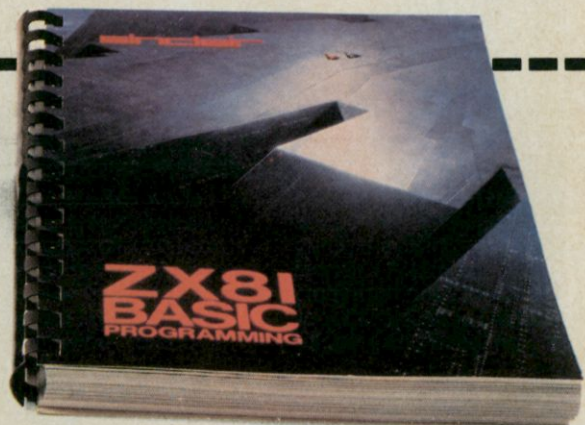

Black Friday

This stock market simulation for the Commodore and Atari systems lets you hone your buying and selling skills in preparation for the real thing.

By Robert W. Baker

This game program provides a realistic simulation of the stock market. It allows one to four players to play a game lasting ten years (or rounds).

The original program (see Jan. 1977 *Byte*, p.56) was written for a DEC-10 time-sharing system and was not easily converted for home computer systems. Since then I've rewritten the program for both the Commodore PET/CBM and the Atari 400/800 systems. Both programs are included (see Listings 1 and 2). The PET version requires a 16K-byte memory and will run on either 40- or 80-column machines. The Atari version requires 24K minimum.

The object of the game is to shrewdly invest \$5000 in the game's ten securities, buying and selling each year in an attempt to become the wealthiest player. Each year all players receive dividends on every paying stock worth \$50 or more. Then each player gets a chance to sell any stocks he owns or buy any stocks he wants.

The player must have enough money to purchase the stocks indicated and must actually own the stocks being sold. If not, an error message is displayed and the player must re-enter the transaction. As each transaction is completed, the table is updated to show the player's new holdings and cash on hand. When all players have completed their transactions, the next year's values are computed and the game continues. At the end of ten years, each player's net worth is calculated and the wealthiest player wins!

If the value of any stock falls to

zero, that stock goes bankrupt and all shares are surrendered. The value is then re-established at \$100. If the value reaches \$150, stocks will split and any players owning shares will receive the extra shares. When splitting, the value of the stock is halved (rounded up to the next highest dollar).

The tables printed each year give the year number, the type of market (bull or bear), the change in value of each stock(+/-), the current price, and the number of shares each player owns of all stocks. Any dividends received for the year will be shown along with each player's total cash on hand.

The available securities and their respective dividends per share are shown in Table 1.

Simple Program Description

Matrix M is used to record each player's holdings, cash on hand, and dividends or interest for each year. The market changes for each year are determined by first selecting at random one of the 36 market vectors in Matrix A. Each of these vectors can be selected only once during the game; element 10 is set to 1 when a vector is used.

The data vectors in this matrix al-

ternately represent bull and bear markets. For a bull market, a vector is selected from matrix U; for a bear market, a vector is selected from matrix E.

This price change vector, again selected at random, is added to the market vector and stored in vector T to record the price change for that year. The price changes are also added to vector F, which keeps track of the current price of each stock. Vector I contains the dividends-per-share values, and Vector S\$ contains the valid stock abbreviations.

Listings 1 and 2 are for Commodore and Atari versions of the program. As you can see, a fair amount of typing is involved, with a number of data statements. I'm willing to provide copies on tape or disk for either system if you'll include \$5 to cover costs. Anyone overseas, please include additional postage. For Commodore systems I can provide 4040 or 8050 format disks; for Atari systems I can only provide DOS 1.0 format disks for the 810 drive. Tapes can be supplied for either system but I'd prefer to send disks whenever possible. Be sure to let me know exactly what you want. ■

Abbrev.	Security name	Div./Share
HIB	Highway Improvement Bonds	\$5
XP	X-Pando Corporation	\$1
SP	Seaside Properties Inc.	none
ODM	Old Dog Mutual Funds	\$4
RD	Rubble Development	\$7
SO	Slippery Oil Company	none
BT	Bumpy Transportation	none
KA	Krash Auto Company	\$2
ZE	Zap Electronics	\$6
BPL	Blinky Power & Light	\$6

Table 1. Stock market securities and dividends.

Address correspondence to Robert W. Baker,
15 Windsor Drive, Atco, NJ 08004.

HIB—Highway Improvement Bonds (yield 5%). An excellent state bond with good security and income potential, but no appreciation.

XP—X-Pando Corporation (yield 1%). A rapidly expanding industrial firm that reinvests most earnings on research, causing low yield. The price-to-earnings ratio is extremely high.

SP—Seaside Properties Inc. (no yield). Good appreciation prospects but no dividends. In the immediate future, however, the proposed beach cleanup program could have great effect on earnings.

ODM—Old Dog Mutual Fund (yield 4%). A common stock mutual fund that represents a good, steady income, with only fair appreciation.

RD—Rubble Development (yield 7%). A high income real estate investment with steadily depreciating capital assets.

SO—Slippery Oil Company (no yield). Very speculative investment since profits go toward new oil wells. No dividends are expected.

BT—Bumpy Transport Company (no yield). High appreciation investment with a good outlook depending on the administrative ability of its new board of directors. No dividends are expected since all profits are recycled into the company.

KA—Krash Auto Company (yield 2%). A medium size auto company representing a somewhat high price-to-earnings ratio with a low yield.

ZE—Zap Electronics Inc. (yield 6%). A highly speculative, high income stock with a fair to poor long term prospect.

BPL—Blinkey Power and Light (yield 3%). A steadily growing utility company in an established industrial area.

Table 2. Securities prospectus.

Listing 1. Black Friday stock market simulation for the Atari 400/800 computers.

```
100 REM ***** ATARI BLACK FRIDAY *****
110 REM
120 REM .....ROBERT W. BAKER.....
130 REM
140 REM 15 WINDSOR DR, ATCO, NJ 08004
150 REM
160 REM *****
170 REM
180 DIM R$(20),S$(32),C$(20)
185 C$=CHR$(125):FOR X=2 TO 20:C$(X,X)=CHR$(29):NEXT X
190 PRINT C$(1,5);"ZZZ BLACK FRIDAY STOCK MARKET GAME ZZZ"
200 DIM A(36,10),U(11,9),E(11,9),M(4,12),I(10),T(10),F(10)
220 S$="*HIB*XP SP ODMRD SO BT KA ZE BPL*"
230 PRINT :PRINT "      *** INITIALIZING DATA! ***"
240 FOR X=1 TO 10:READ N:NEXT X
250 FOR N=1 TO 36:FOR J=1 TO 9:READ X
260 A(N,J)=X:NEXT J:NEXT N
290 FOR R=1 TO 2:FOR N=1 TO 11:FOR J=1 TO 9:READ X
300 IF R=1 THEN U(N,J)=X
310 IF R=2 THEN E(N,J)=X
320 NEXT J:NEXT N:NEXT R
325 REM === STOCK YIELDS (DIVIDENDS)
330 DATA 5,1,0,4,7,0,0,2,6,3
340 RESTORE :FOR N=1 TO 10:READ X:I(N)=X:F(N)=0:T(N)=100:NEXT N
350 FOR N=1 TO 4:FOR J=2 TO 12:M(N,J)=0:NEXT J:M(N,1)=5000:NEXT N
360 FOR N=1 TO 36:A(N,10)=0:NEXT N:Y=0
370 PRINT C$(2,5);"NUMBER OF PLAYERS (1 TO 4) ";
380 INPUT R$:P=VAL(R$):IF P>4 OR P<1 THEN 370
382 REM =====
384 REM COMPUTE PRICES
386 REM =====
390 PRINT C$(1,2);"*** COMPUTING NEXT YEAR ***":PRINT :PRINT
395 W1=0:D=INT(11*RNDRND(0)+1)
400 C=INT(36*RNDRND(0)+1)
410 IF A(C,10)=1 THEN 400
450 FOR N=2 TO 10:IF INT(C/2)<>INT((C-1)/2) THEN 470
460 R$="BULL":F(N)=A(C,N-1)+U(D,N-1):GOTO 480
470 R$="BEAR":F(N)=A(C,N-1)+E(D,N-1)
472 REM =====
475 REM CHECK STOCK SPLITS
476 REM =====
480 T(N)=T(N)+F(N):IF T(N)<150 THEN 530
```

More →

Circle 179 on Reader Service card.

What do these Superior Programs have in common?

Apple Graphics II Senior Analyst

Apple Computer Corp.

VersaForm

Applied Software Techn

Cascade II

Cascade Graphics Corp.

Diff-E-Q

Sage Software

DSS/F

Financial Modeling

Addison Wesley

Market Analyst

Anidata

Ag•Pac

Wisconsin Software

Visischedule

VisiCorp

Accounting Management

Great Plains

Job Control

High Technology

THEY'RE EVEN MORE VALUABLE WITH THE PASCAL SPEEDUP SYSTEM!

IF YOU VALUE YOUR TIME, THE PSS Hardware/Software package will pay for itself within a few weeks!

System includes THE MILL 6809 COPROCESSOR BOARD + System software & Printer Spooler.

PLUG IT IN & GO!

*For Apple Hobbyists: THE ASSEMBLER DEVELOPMENT KIT; Create 6502-6809 DOS 3.3 compatible programs



The Lobero Building - M12

P.O. Box 2342

Santa Barbara, CA 93120 (805) 966-1140

500 K Great Reasons to Buy Your Diskettes from Snappware!

Byte for byte, performance counts. Every byte of data you record is important. That's why Snappware offers Scotch diskettes, the highest quality diskette on the market at very competitive prices. Scotch diskettes are tested and guaranteed error-free. And the low abrasivity saves your read/write heads.

Scotch Brand 744-0

5¼ inch single sided, single density, soft sectored with hub rings.

One box	\$23.00/box
Five boxes	\$22.50/box
Ten boxes	\$22.00/box
Twenty boxes	\$21.50/box

Scotch Brand 744D-0

The premium grade mini-floppy. Double density certified, with hub rings. The very finest available for your Model III.

One box	\$27.00/box
Five boxes	\$26.50/box
Ten boxes	\$26.00/box
Twenty boxes	\$25.50/box

Scotch Brand 741-0

Eight inch single sided, double density soft sectored. The very finest available for your Model II.

One box	\$33.00/box
Five boxes	\$32.00/box
Ten boxes	\$31.00/box
Twenty boxes	\$30.00/box

When it comes to diskettes, we have the best price per byte.



Authorized 3M
Distributor
Information
Processing
Products

SNAPPWARE SNAPPWARE

Time saving power at your
fingertips.



Master Charge



CALL TOLL FREE:

1-800-543-4628

OHIO RESIDENTS
CALL COLLECT: (513) 891-4496
3719 Mantell
Cinti., Ohio 45236

Listing 1 continued.

```

490 Z=3*(N-1)+2:PRINT "*** ";S$(Z,Z+2);" STOCKS SPLIT ***"
500 J=INT(T(N)/2):IF T(N)/2 THEN T(N)=J:GOTO 520
510 T(N)=J+1
520 FOR J=1 TO P:M(J,N+1)=M(J,N+1)*2:NEXT J
522 REM =====
525 REM CHECK BANKRUPTCIES
527 REM =====
530 IF T(N)>0 THEN 570
540 T(N)=100:FOR J=1 TO P:M(J,N+1)=0:NEXT J
550 Z=3*(N-1)+2:PRINT "*** ";S$(Z,Z+2);" WENT BANKRUPT ***"
560 PRINT "THESE STOCKS ARE BEING SURRENDERED"
570 NEXT N
572 REM =====
575 REM UPDATE DISPLAY
577 REM =====
580 FOR N=1 TO P:M(N,12)=0
590 FOR J=1 TO 10:IF T(J)>=50 THEN M(N,12)=M(N,12)+(I(J)*M(N,J+1))
600 NEXT J:M(N,1)=M(N,1)+M(N,12):NEXT N:Y=Y+1
620 PRINT C$(1,1);"ZZ% YEAR ";Y;" ZZ% ";R$(1,4);" MARKET ZZ%"
630 IF Y<>11 THEN 640
635 PRINT CHR$(28);:FOR X=1 TO 5:PRINT CHR$(31);:NEXT X:PRINT " CLOSING "
640 PRINT:PRINT " +/- NEW --PLAYER HOLDINGS--"
650 PRINT "STK CHNG COST .1.. .2.. .3.. .4..":PRINT
660 FOR X=1 TO 10:GOSUB 950:NEXT X:PRINT:PRINT "DIV'S THIS YR ";
665 R$=""
670 FOR J=1 TO P:Z=5-LEN(STR$(M(J,12))):PRINT " ";M(J,12);
673 IF Z>=1 THEN PRINT R$(1,Z);
675 IF J=4 THEN PRINT CHR$(28);
676 NEXT J:PRINT:GOSUB 980
680 IF Y=11 THEN 1020
682 REM =====
685 REM PLAYER TRANSACTIONS
687 REM =====
690 FOR N=1 TO P
700 GOSUB 880
710 PRINT "PLAYER# ";N;" (B=BUY,S=SELL,D=DONE) ";
715 INPUT R$:IF R$(1,1)="D" THEN 870
720 IF R$(1,1)="S" THEN 780
730 IF R$(1,1)<>"B" THEN 700
735 REM --- BUY SHARES ---
740 GOSUB 900:PRINT "NUMBER OF SHARES BUYING ";
750 INPUT R$:R=VAL(R$):IF R<1 THEN PRINT "BAD INPUT!":GOTO 820
760 IF R*(X)>M(N,1) THEN PRINT "NOT ENOUGH MONEY!":GOTO 820
770 M(N,X+1)=M(N,X+1)+R:M(N,1)=M(N,1)-(R*(X)):GOTO 850
775 REM --- SELL SHARES ---
780 GOSUB 900:PRINT "NUMBER OF SHARES SELLING ";
790 INPUT R$:R=VAL(R$):IF R<1 THEN PRINT "BAD INPUT!":GOTO 820
800 IF R<M(N,X+1) THEN M(N,X+1)=M(N,X+1)-R:M(N,1)=M(N,1)+(R*(X)):GOTO 850
810 PRINT "NOT ENOUGH SHARES!"
820 FOR X=1 TO 100:NEXT X
840 GOTO 700
845 REM --- UPDATE DISPLAY ---
850 POKE 84,0:PRINT C$(2,5);:FOR J=1 TO X:PRINT CHR$(29);:NEXT J:GOSUB 950
860 FOR J=1 TO (12-X):PRINT CHR$(29);:NEXT J:GOSUB 980:GOTO 700
870 NEXT N:GOTO 390
872 REM =====
875 REM *-x-x SUBROUTINES *-x-x
877 REM =====
880 GOSUB 890:FOR J=1 TO 4:GOSUB 1000:NEXT J
890 POKE 84,0:PRINT C$(2,20);:RETURN
900 PRINT "STOCK ABBREV ";:INPUT R$:IF LEN(R$)=3 THEN 910
903 IF LEN(R$)<>2 THEN 940
906 R$(3,3)=" "
910 W1=0:FOR J=0 TO 9:X=J+1
920 IF R$(1,3)=S$((J*3)+2,(J*3)+4) THEN W1=1:J=9
930 NEXT J:IF W1=1 THEN RETURN
940 GOSUB 890:PRINT CHR$(29);:GOSUB 1010:GOTO 900
950 GOSUB 1010:Z=3*(X-1)+2:PRINT S$(Z,Z+2);" ";F(X);
960 Z=5-LEN(STR$(F(X)))
965 R$="" :PRINT R$(1,Z);T(X);
967 Z=4-LEN(STR$(T(X))):PRINT R$(1,Z);
970 FOR J=1 TO P:Z=5-LEN(STR$(M(J,X+1))):PRINT " ";M(J,X+1);
973 IF Z>=1 THEN PRINT R$(1,Z);
975 IF J=4 THEN PRINT CHR$(28);
976 NEXT J:PRINT:RETURN
980 GOSUB 1010:PRINT "CASH TOTAL = ";
985 R$=""
990 FOR J=1 TO P:Z=5-LEN(STR$(M(J,1))):PRINT " ";M(J,1);
993 IF Z>=1 THEN PRINT R$(1,Z);
995 IF J=4 THEN PRINT CHR$(28);
996 NEXT J:PRINT:RETURN
999 REM NEXT LINE HAS 39 SPACES...
1000 PRINT " ";CHR$(28):RETURN
1010 GOSUB 1000:PRINT CHR$(28);:RETURN
1020 FOR N=1 TO P:FOR J=1 TO 10:M(N,1)=M(N,1)+(T(J)*M(N,J+1)):NEXT J:NEXT N
1030 PRINT:PRINT "NET WORTH = ";:GOSUB 990
1040 PRINT:PRINT:PRINT "PLAY AGAIN (Y OR N) ";
1050 INPUT R$:IF R$(1,1)="N" THEN PRINT CHR$(125);:END
1060 IF R$(1,1)="Y" THEN PRINT CHR$(125);:GOTO 340
1070 PRINT CHR$(28);:GOSUB 1010:GOTO 1040
0
1072 REM =====
1075 REM *-x-x GAME DATA *-x-x
1077 REM =====
1080 DATA 0,0,0,0,0,0,0,0,5
1090 DATA 0,0,0,0,0,-25,0,0,0
1100 DATA 0,0,0,0,0,0,15,0,0
1110 DATA 0,0,0,-5,0,0,0,0,0
1120 DATA 0,0,0,0,0,0,0,0,5
1130 DATA 0,0,0,0,0,5,0,0,0
1140 DATA 0,0,0,0,0,10,0,0,0
1150 DATA 0,10,0,0,0,0,0,0,0
1160 DATA 0,0,0,0,0,15,0,0,0

```

More



49^{\$}

The editor that became an industry standard

What's the catch?

It's our Mini version of VEDIT, but still with more power and flexibility than most editors on the market today. It's better than an earlier version of VEDIT for which thousands of highly satisfied users paid up to \$185.

HERE'S WHAT YOU GET

Exceptional speed and true 'What you see is what you get' full screen editing for program development and text documents. It completely replaces ED (and EDLINE). VEDIT supports all of the new CRT terminals, video boards and 8080, Z80 and 8086 computers. The unique menu driven customization lets you determine your own keyboard layout using any available cursor and function keys. And you can configure a lot more for your particular applications and preferences.

Powerful editing capabilities such as text Move and Copy, complete file handling on multiple drives, iteration macros, printing, an 'Undo' key, and recovery from full disk conditions (you can delete files or change disks). Among its many special features are automatic indenting for use with structured programming languages such as Pascal, 'C' and PL/I, and features which make editing Assembler and COBOL programs a snap. You can even insert a specified line range of another file anywhere in the text, and change disks in the middle of an edit session.

HERE'S WHAT YOU DON'T GET

You don't get our newest features, including word processing, ten text buffers, 'TECO' like command macros and auto-startup. You do get the complete new 125 page manual for both beginning and experienced users.

BUT HERE'S THE BEST PART

We often hear from users that VEDIT has them hooked; they don't want to use any other editor again. If it happens to you, we will apply the \$49 to the full version of VEDIT.

Ordering - Please specify your microcomputer, video board or the CRT terminal version, 8080, Z80 or 8086 code, and disk format. \$49 prepaid. (Shipping: Credit card - \$3, Overseas - \$10, Purchase Order - \$10).

Or order our full version: 8080 and Z80 - \$150, 8086 - \$195, Manual Only - \$18.

VISA and MasterCard

CP/M, CP/M-86 and MP/M are trademarks of Digital Research, Inc. Apple II is a registered trademark of Apple Computer, Inc. Softcard is a trademark of Microsoft. TRS-80 is a trademark of Tandy Corporation.

CompuView

PRODUCTS, INC.

1955 Pauline Blvd., Suite 200 Ann Arbor, Michigan 48103 • (313) 996-1299

IBM * Apple II Softcard * TRS-80 II and I * SuperBrain * Zenith Z89 * Xerox 820 * Cromemco * NorthStar * DEC VT180
Televideo * Altos * Vector * Micropolis * MP/M * CP/M-86 * MSDOS

We Have It!
..at the best prices

DISK SPECIAL
MEMOREX 3401 5 1/4"
SINGLE SIDED, SINGLE DENSITY
1 Box 10 Boxes
\$22.95 ea. \$20.95 ea.

We have a complete inventory including soft sectored, hard sectored and special formats. Even if your part number is not listed, **WE STOCK IT IF THEY MAKE IT.**

Call for quantity pricing

— MAXELL —

- MD1] 5 1/4" SINGLE SIDED \$32.95
- MH1] SINGLE OR DBL. DENSITY
- MD2] 5 1/4" DOUBLE SIDED \$48.95
- MH2] SINGLE OR DBL. DENSITY
- MD1 DD-5 1/4" SS, QUAD DENSITY \$44.95
- MD2 DD-5 1/4" DS, QUAD DENSITY \$54.95
- FD1] 8" SINGLE SIDED \$43.95
- FH1] SINGLE OR DBL. DENSITY
- FD2] 8" DOUBLE SIDED \$56.95
- FH2] SINGLE OR DBL. DENSITY

— MEMOREX —

- 3481] 5 1/4" SINGLE SIDED
- 3483] SINGLE OR DBL. DENSITY \$28.95
- 3485] w/HUBRING
- 3491] 5 1/4" DOUBLE SIDED
- 3493] SINGLE OR DBL. DENSITY \$36.95
- 3493] w/HUBRING
- 3504] 5 1/4" SS, QUAD DENSITY \$37.95
- 3501] 5 1/4" DS, QUAD DENSITY \$51.95
- 3062] 8" SINGLE SIDED \$26.95
- 3015] SINGLE DENSITY
- 3090] 8" SNG. SIDE, DBL. DENSITY \$35.95
- 3104] 8" DBL. SIDE, DBL. DENSITY \$41.95

— SCOTCH —

- 744] 5 1/4" SINGLE SIDED, SNG. DENS. w/HUBRING \$28.95
- 744D] 5 1/4" SINGLE SIDED, DBL. DENS. w/HUBRING \$33.95
- 745] 5 1/4" DOUBLE SIDED, DBL. DENS. w/HUBRING \$40.95
- 740-] 8" SNG. SIDE, SNG. DENSITY \$29.95
- 741-] 8" SNG. SIDE, DBL. DENSITY \$37.95
- 743-] 8" DBL. SIDE, DBL. DENSITY \$47.95

HEAD CLEANING KITS, 5 1/4" OR 8" .. \$22.95

Minimum shipping charge-\$3.00 Shipped UPS. All offers subject to withdrawal without notice. advertised prices reflect a 2% cash discount (orders prepaid prior to shipment). C.O.D.'s and credit card orders are 2% higher.

 **Mini Micro Mart, Inc.** 
Box 2992K Syracuse, N.Y. 13220
315-422-2056
TWX 710-541-0431
WRITE FOR FREE CATALOG

Listing 1 continued.

```

1170 DATA 0,-5,0,0,0,0,0,0,0
1180 DATA 8,5,5,0,0,0,7,0,0
1190 DATA 0,0,0,0,0,0,0,-25,0
1200 DATA 0,0,0,0,0,0,0,10,0
1210 DATA 0,-10,0,0,0,0,0,0,0
1220 DATA 0,5,0,0,0,0,0,0,0
1230 DATA 10,0,0,0,0,0,0,0,0
1240 DATA 0,0,0,0,17,0,0,0,0
1250 DATA 0,0,0,0,-15,0,0,0,0
1260 DATA 0,0,0,0,0,0,10,0,0
1270 DATA 0,0,0,0,0,0,-15,0,0
1280 DATA 0,0,0,0,0,0,10,0,0
1290 DATA 0,0,0,0,0,0,-15,0,0
1300 DATA 0,0,-8,0,8,0,0,5,0
1310 DATA -10,0,0,0,0,0,0,0,0
1320 DATA 8,0,0,0,0,0,0,0,0
1330 DATA 0,0,0,0,0,0,-5,0,0
1340 DATA 0,0,3,0,0,0,0,0,4
1350 DATA -8,0,0,0,0,0,0,0,0
1360 DATA 0,0,0,5,0,0,0,0,0
1370 DATA 0,0,0,0,-10,0,0,0,0
1380 DATA 0,0,0,0,0,10,0,0,0
1390 DATA -8,-5,0,0,0,0,-7,0,0
1400 DATA 10,0,0,0,0,0,0,0,0
1410 DATA 0,0,0,0,0,0,0,-14
1420 DATA -10,0,0,0,0,0,0,0,0
1430 DATA 0,0,0,0,0,-5,0,0,0
1440 DATA -2,-10,-7,-9,-2,-9,-7,-16,-4
1450 DATA 26,16,25,8,-14,21,14,-4,17
1460 DATA 18,23,11,12,46,18,-5,34,15
1470 DATA 23,28,-2,11,56,19,30,29,14
1480 DATA 20,15,15,7,-20,15,13,-10,12
1490 DATA 17,21,13,-2,37,23,23,19,14
1500 DATA 19,24,17,9,-5,26,13,-7,15
1510 DATA 11,18,14,11,67,15,22,18,13
1520 DATA 13,31,1,14,-11,18,18,-14,10
1530 DATA 14,-8,19,-1,-9,25,-10,13,19
1540 DATA 24,24,23,20,51,27,38,33,18
1550 DATA 12,14,13,10,10,20,21,25,8
1560 DATA 7,-6,10,-10,30,6,-19,22,-2
1570 DATA 9,10,7,-5,-20,12,21,18,7
1580 DATA 7,8,5,-6,-40,3,16,-14,4
1590 DATA 8,6,4,-4,40,8,4,-12,3
1600 DATA 6,4,3,3,-15,5,8,-8,5
1610 DATA 5,7,-1,-3,45,6,-10,10,4
1620 DATA -2,6,-3,-8,-20,7,10,14,6
1630 DATA 11,11,-5,-7,30,10,-11,-18,-4
1640 DATA -5,13,-8,6,25,4,18,-22,-4
1650 DATA -8,-10,-10,-15,-20,-20,-23,-25,-7
    
```

Listing 2. Black Friday for PET.

```

100 REM ***** PET BLACK FRIDAY *****
110 REM
120 REM          ROBERT W. BAKER
130 REM
140 REM          15 WINDSOR DR, ATCO,NJ 08004
150 REM
160 REM *****
170 :
180 POKES9468,12
190 PRINT"***** BLACK FRIDAY STOCK MARKET GAME ***"
195 REM          ↑ CLR/HOME & 4 CURSOR DOWNS
200 DIM A(36,10),U(11,9),E(11,9),M(4,12)
210 FOR N=1 TO VAL(RIGHT$(TI$,2)):X=RND(1):NEXT N
220 S$="*HIBXP SP ODMRD SO BT KA ZE BPL*"
230 PRINT:PRINT"*** INITIALIZING DATA!"
240 FOR X=1 TO 10:READ N:NEXT
250 FOR N=1 TO 36:FOR J=1 TO 9:READ X
260 A(N,J)=X:NEXT J,N
290 FOR R=1 TO 2:FOR N=1 TO 11:FOR J=1 TO 9:READ X
300 IF R=1 THEN U(N,J)=X
310 IF R=2 THEN E(N,J)=X
320 NEXT J,N,R
330 DATA 5,1,0,4,7,0,0,2,6,3
340 RESTORE:FOR N=1 TO 10:READ I(N):F(N)=0:T(N)=100:NEXT N
350 FOR N=1 TO 4:FOR J=2 TO 12:M(N,J)=0:NEXT J:M(N,1)=5000:NEXT N
360 FOR N=1 TO 36:A(N,10)=0:NEXT N:Y=0
370 PRINT"*****NUMBER OF PLAYERS (1 TO 4) 1****";
375 REM          ↑ 4 CURSOR DOWN          ↑ 3 CURSOR LEFT
380 INPUT R$:P=VAL(R$):IF P>4 OR P<1 THEN 370
382 REM *****
385 REM COMPUTE PRICES
387 REM *****
390 PRINT"***** COMPUTING NEXT YEAR *****":W1=0:D=INT(11*RND(1)+1)
395 REM          ↑ CLR/HOME & CURSOR DOWN          ↑ 2 CURSOR DOWN
400 C=INT(36*RND(1)+1)
410 IF A(C,10)=1 THEN 400
450 FOR N=2 TO 10:IF INT(C/2)<>INT((C-1)/2) THEN 470
460 R$="BULL":F(N)=A(C,N-1)+U(C,N-1):GOTO 480
470 R$="BEAR":F(N)=A(C,N-1)+E(C,N-1)
474 REM *****
475 REM CHECK STOCK SPLITS
477 REM *****
480 T(N)=T(N)+F(N):IF T(N)<150 GOTO 530
    
```

More →

Listing 2 continued.

```

490 PRINT"*** ";MID$(S$,3*(N-1)+2,3);" STOCKS SPLIT ***"
500 J=INT(T(N)/2):IF T(N)/2=J THEN T(N)=J:GOTO 520
510 T(N)=J+1
520 FOR J=1 TO P:M(J,N+1)=M(J,N+1)*2:NEXT J
522 REM =====
525 REM CHECK BANKRUPTCIES
527 REM =====
530 IF T(N)>0 THEN 570
540 T(N)=100:FOR J=1 TO P:M(J,N+1)=0:NEXT J
550 PRINT"*** ";MID$(S$,3*(N-1)+2,3);" WENT BANKRUPT ***"
560 PRINT"THESE STOCKS ARE BEING SURRENDERED"
570 NEXT N
572 REM =====
575 REM UPDATE DISPLAY
577 REM =====
580 FOR N=1 TO P:M(N,12)=0
590 FOR J=1 TO 10:IF T(J)=50 THEN M(N,12)=M(N,12)+(I(J)*M(N,J+1))
600 NEXT J:W1=TI:M(N,1)=M(N,1)+M(N,12):NEXT N:Y=Y+1:IF W1<1 THEN 620
610 IF TI-W1<30 GOTO 610
620 PRINT"YEAR ";Y;" MARKET "
630 IF Y=11 THEN PRINT" CLOSING "
635 REM          1CURSOR UP & 5 CURSOR RIGHT
640 PRINT TAB(5);"M+/- NEW PLAYER HOLDINGS---"
650 PRINT"STK CHNG PRICE .1.. .2.. .3.. .4..":PRINT
660 FOR X=1 TO 10:GOSUB 950:NEXT X:PRINT:PRINT"DIV'S THIS YR";
670 FOR J=1 TO P:PRINT TAB(15+((J-1)*6));M(J,12):NEXT J:PRINT:PRINT:GOSUB 980
680 IF Y=11 THEN 1020
682 REM =====
685 REM PLAYER TRANSACTIONS
687 REM =====
690 FOR N=1 TO P
700 GOSUB 880
710 PRINT"PLAYER" M(B=BUY,S=SELL,D=DONE) ?????:INPUT R$:IF R$="D" THEN 870
715 REM   TRVS   TRVS OFF          13 CURSOR LEFT
720 IF R$="S" GOTO 780
730 IF R$="B" GOTO 700
735 REM   BUY SHARES   ===
740 GOSUB 900:PRINT"NUMBER OF SHARES BUYING ?????:REM + 3 CURSOR LEFT
750 INPUT R$:R=VAL(R$):IF R<1 THEN PRINT"BAD INPUT!":GOTO 820
760 IF R*(X)>M(N,1) THEN PRINT"NOT ENOUGH MONEY!":GOTO 820
770 M(N,X+1)=M(N,X+1)+R:M(N,1)=M(N,1)-(R*(X)):GOTO 850
775 REM   SELL SHARES   ===
780 GOSUB 900:PRINT"NUMBER OF SHARES SELLING ?????:REM + 3 CURSOR LEFT
790 INPUT R$:R=VAL(R$):IF R<1 THEN PRINT"BAD INPUT!":GOTO 820
800 IF R<M(N,X+1) THEN M(N,X+1)=M(N,X+1)-R:M(N,1)=M(N,1)+(R*(X)):GOTO 850
810 PRINT"NOT ENOUGH SHARES!"
820 W1=TI
830 IF TI-W1<60 GOTO 830
840 GOTO 700
845 REM   UPDATE DISPLAY FOR TRANSACTIONS   ===
850 PRINT" :FOR J=1 TO X:PRINT" :NEXT J:GOSUB 950
855 REM   HOME & 4 CURSOR DOWN   1CURSOR DOWN
860 FOR J=1 TO (13-X):PRINT" :NEXT J:GOSUB 980:GOTO 700
865 REM   1CURSOR DOWN
870 NEXT N:GOTO 390
872 REM =====
875 REM *** SUBROUTINES ***
877 REM =====
880 GOSUB 890:FOR J=1 TO 4:GOSUB 1000:NEXT J
890 PRINT" :RETURN
895 REM   HOME & 19 CURSOR DOWN
900 PRINT"STOCK ABBREV ?????:INPUT R$:R$=LEFT$(R$," ,3)
905 REM   1 3 CURSOR LEFT
910 W1=0:FOR J=0 TO 9:X=J+1
920 IF R=MID$(S$,J*3+2,3) THEN W1=1:J=9
930 NEXT J:IF W1=1 THEN RETURN
940 GOSUB 890:PRINT" :GOSUB 1010:GOTO 900
945 REM   1 CURSOR DOWN
950 GOSUB 1010:PRINT MID$(S$,3*(X-1)+2,3);SPC(2);F(X);
960 PRINT SPC(4-LEN(STR$(F(X))))T(X);
970 FOR J=1 TO P:PRINT TAB(16+((J-1)*6));M(J,X+1):NEXT J:PRINT:RETURN
980 GOSUB 1010:PRINT"CASH TOTAL =";
990 FOR J=1 TO P:PRINT TAB(15+((J-1)*6));M(J,1):PRINT" :NEXT J:PRINT:RETURN
992 REM LAST LINE USES CURSOR UP
995 REM NEXT LINE HAS 39 SPACES
1000 PRINT" :RETURN
1010 GOSUB 1000:PRINT" :RETURN:REM + CURSOR UP
1020 FOR N=1 TO P:FOR J=1 TO 10:M(N,1)=M(N,1)+(T(J)*M(N,J+1)):NEXT J:NEXT N
1030 PRINT:PRINT"NET WORTH =":GOSUB 990
1040 PRINT:PRINT:PRINT"PLAY AGAIN (Y OR N) N????:REM +3 CURSOR LEFT
1050 INPUT R$:IF R$="N" THEN PRINT" :END:REM +CLEAR/HOME
1060 IF R$="Y" THEN PRINT" :GOTO 340:REM + CLR/HOME
1070 PRINT" :GOSUB 1010:GOTO 1040:REM + CURSOR UP IN PRINT
1072 REM =====
1075 REM *** GAME DATA ***
1077 REM =====
1080 DATA 0,0,0,0,0,0,0,0,5
1090 DATA 0,0,0,0,0,-25,0,0,0
1100 DATA 0,0,0,0,0,0,15,0,0
1110 DATA 0,0,0,-5,0,0,0,0,0
1120 DATA 0,0,0,0,0,0,0,0,5
1130 DATA 0,0,0,0,0,0,5,0,0,0
1140 DATA 0,0,0,0,0,0,10,0,0,0
1150 DATA 0,10,0,0,0,0,0,0,0,0
1160 DATA 0,0,0,0,0,0,15,0,0,0
1170 DATA 0,-5,0,0,0,0,0,0,0,0
1180 DATA 8,5,5,0,0,0,0,7,0,0
1190 DATA 0,0,0,0,0,0,0,-25,0,0
1200 DATA 0,0,0,0,0,0,0,0,10,0
1210 DATA 0,-10,0,0,0,0,0,0,0,0
1220 DATA 0,5,0,0,0,0,0,0,0,0

```

More

Big sale on K's!

16K... \$149.95

32K... \$199.95

48K... \$249.95

64K... \$299.95

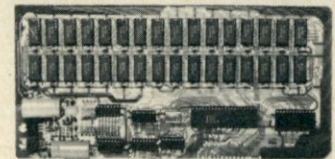

New JAWS-IB

The Ultrabyte Memory Board

Due to the tremendous success of our JAWS I, we were able to make a special purchase of first-quality components at below-cost prices for JAWS-IB. And we are sharing our cost saving with you. But don't be surprised if the next time you see this ad the prices have gone up substantially. Better yet, order now, and get the best memory on the market at the best price on the market.

ONE CHIP DOES IT ALL
Jaws-IB is the Rolls-Royce of all the S100 dynamic boards. Its heart is Intel's single chip 64K dynamic RAM controller. Eliminates high-current logic parts... delay lines... massive heat sinks... unreliable trick circuits. JAWS-IB solves all these problems.

LOOK WHAT JAWS-IB OFFERS YOU
Hidden refresh... fast performance... low power consumption... latched data outputs... 200 NS 4116 RAM's... on-board crystal... RAM Jumper selectable on 8K boundaries... fully socketed... solder mask on both sides of board... phantom line... designed for 8080, 8085, and Z80 bus signals... works in Explorer, Sol, Horizon, as well as all other well-designed S100 computers.

10-DAY MONEY-BACK TRIAL: Try a fully wired and tested board for 10 days... then either keep it, return it for kit, or simply return it in working condition.

Continental U.S.A. Credit Card Buyers Outside Connecticut:
TO ORDER CALL TOLL FREE 800-243-7428
From Connecticut Or For Assistance:
(203) 354-9375 **KB8**

Please send the items checked below:

- JAWS-IB kit:**
- 16K..... \$149.95*
 - 32K..... \$199.95*
 - 48K..... \$249.95*
 - 64K..... \$299.95*

- JAWS-IB Fully Assembled, Wired & Tested:**
- 16K..... \$179.95*
 - 32K..... \$239.95*
 - 48K..... \$299.95*
 - 64K..... \$359.95*

EXPANSION KIT, 16K RAM Module, to expand JAWS-IB in 16K blocks up to 64K. **\$59.95**
*All prices plus \$2 postage and insurance (\$4.00 Canada). Connecticut residents add sales tax.

Total enclosed: \$ _____

Personal Check Money Order or Cashier's Check
 VISA Master Card (Bank No. _____)

Acct. No. _____ Exp. Date _____

Signature _____
Print Name _____

Address _____
City _____
State _____ Zip _____

NETRONICS R&D Ltd.
333 Litchfield Road, New Milford, CT 06776

FREE ?

CHEMIN
The Multicultural European Card Game
with the Most Exciting American Dealer

win & get a check ...



...lose & pay the price

OR !

**TIRED OF ONLY PLAYING GAMES WITH YOUR COMPUTER ?
READY FOR SOME SERIOUS SOFTWARE ?**

We will custom develop programs tailored to your desires
OR
Provide our own Quality Programs
ALL at unbelievably **LOW PRICES**

We will even send you royalty payments when we re-sell programs we developed at your suggestion !

PERSONAL PROGRAMS ALREADY DEVELOPED

VALUE - Important assets logging/tracking program. Organize for wills, taxes, insurance, etc. **\$24.95**

HOUSEHOLD - Keep track of all household goods by room. Compile total cost new, current value, and replacement costs. **\$24.95**

TICKLE - Reminder of things to be done. Sorted by date to be done, deleted as each finished **\$ 9.95**

TEACHER - Friendly, informative, 1st time user introduction to computers. Makes basic operation of the machine enjoyable and easy to learn. **\$24.95**

ALL RUN ON OSBORNE
OR ON ANY MACHINE WITH MICROSOFT BASIC OR CROMENCO 32K BASIC
QUANTITY DISCOUNTS available to dealers and User Groups
CHEMIN USES CURSOR ADDRESSING. TESTED ON OSBORNE, TELEVIDEO, INTERTUBE,
ADM, & HAZLETINE. APPLE; TRS-80 versions being developed

ARTCOM DATA SERVICE <313> 522-3377
P.O. BOX 9343 LIVONIA, MI. 48150

YOU COULD GET THIS GAME FREE !

FEEL LUCKY?

price > \$24.95
INTRODUCTORY OFFER REBATES FROM \$0 to \$25

Write or Call for Details
Up to \$5 credit on order for
Phone call order

Listing 2 continued.

1230 DATA 10,0,0,0,0,0,0,0,0,0
1240 DATA 0,0,0,0,17,0,0,0,0,0
1250 DATA 0,0,0,0,-15,0,0,0,0,0
1260 DATA 0,0,0,0,0,0,0,10,0,0
1270 DATA 0,0,0,0,0,0,0,-15,0,0
1280 DATA 0,0,0,0,0,0,0,10,0,0
1290 DATA 0,0,0,0,0,0,0,-15,0,0
1300 DATA 0,0,-8,0,0,0,0,0,5,0
1310 DATA -10,0,0,0,0,0,0,0,0,0
1320 DATA 0,0,0,0,0,0,0,0,0,0
1330 DATA 0,0,0,0,0,0,0,-5,0,0
1340 DATA 0,0,3,0,0,0,0,0,0,4
1350 DATA -8,0,0,0,0,0,0,0,0,0
1360 DATA 0,0,0,5,0,0,0,0,0,0
1370 DATA 0,0,0,0,0,-10,0,0,0,0
1380 DATA 0,0,0,0,0,0,0,10,0,0
1390 DATA -8,-5,0,0,0,0,0,-7,0,0
1400 DATA 10,0,0,0,0,0,0,0,0,0
1410 DATA 0,0,0,0,0,0,0,0,-14
1420 DATA -10,0,0,0,0,0,0,0,0,0
1430 DATA 0,0,0,0,0,-5,0,0,0,0
1440 DATA -2,-10,-7,-9,-2,-9,-7,-16,-4
1450 DATA 26,16,25,8,-14,21,14,-4,17
1460 DATA 18,23,11,12,46,18,-5,34,15
1470 DATA 23,28,-2,11,56,19,30,29,14
1480 DATA 20,15,15,7,-20,15,13,-10,12
1490 DATA 17,21,13,-2,37,23,19,14
1500 DATA 19,24,17,9,-5,26,13,-7,15
1510 DATA 11,18,14,11,67,15,22,18,13
1520 DATA 13,31,1,14,-11,18,18,-14,10
1530 DATA 14,-8,19,-1,-9,25,-10,13,19
1540 DATA 24,24,23,20,51,27,38,33,18
1550 DATA 12,14,13,10,10,20,21,25,8
1560 DATA 7,-6,10,-10,30,6,-19,22,-2
1570 DATA 9,10,7,-5,-20,12,21,18,7
1580 DATA 7,8,5,-6,-40,3,16,-14,4
1590 DATA 8,6,4,-4,40,8,4,-12,3
1600 DATA 6,4,3,3,-15,5,8,-8,5
1610 DATA 5,7,-1,-3,45,6,-10,10,4
1620 DATA -2,6,-3,-8,-20,7,10,14,6
1630 DATA 11,11,-5,-7,30,10,-11,-18,-4
1640 DATA -5,13,-8,6,25,4,18,-22,-4
1650 DATA -8,-10,-10,-15,-20,-20,-23,-25,-7
READY.

Microcomputing welcomes conversions of this program for the Apple, Heath, IBM PC and Sinclair.

THE HAPPY COMPUTER Software at Affordable Prices!

We'll match any advertised price on the items that we carry. If you find a lower price within 30 days of purchase, show us the ad and we'll refund the difference. Please check system's requirements before ordering!

34% OFF
*Special Items Discount

6502 Business

Apple/Atari/Commodore

Howard Software*

82 Tax Preparer \$ 115
State CA/ILL/NY/NJ \$ 60
Others 20% Off

On-Line Systems*

The Gen. Mgr. \$ 120
Screenwriter II \$ 99
The Dictionary \$ 70
Expediter II + \$ 94
Others 25% Off

Software Publishing*

PFS II \$ 95
Reports II \$ 77
PFS III \$ 145
Reports III \$ 99

Stoneware*

DB Master \$ 160
Pak #1 \$ 80
Pak #2 \$ 80
Stat Pak \$ 80

VisiCorp*

*Visicalc 1 \$ 165
*Visifile 2 \$ 185
*Visitrend/Plot 3 \$ 215
*Visipack 1, 2, & 3 \$ 550
Visischedule \$ 235
Others 25% Off

CP/M Business

Accounting Plus*

Gen. Ledger Acc. Payable
Acc. Receivable Inventory
1 module \$ 475/285
2 modules \$ 855/550
3 modules \$1230/650
4 modules \$1595/875
Others \$ 353/300
(CP/M*/Apple*)

Ashton-Tate*

dBase II \$ 460
Datamost*
Tax Beater \$ 99
R.E.A.P. \$ 99
Write-On
II, III, IBM PC \$ 99

Micropro*

*Wordstar \$ 259/198
*Mailmerge \$ 79/69
*Both \$ 336/265
Datastar \$ 195/168
Spellstar \$ 129/118
Calcstar \$ 159/118
Supersort I \$ 145/115
Supersort II \$ 140/
Wordmaster \$ 95/
Others 33% Off (CP/M*/Apple*)

Nexus*

*Zip dBase II \$ 107
MBasic \$ 107
CBasic \$ 107

Sorcim*

Supercalc \$ 194
Supewriter \$ 337
Apple II 5 1/4
IBM PC 5 1/4
Others 20% Off

Recreational

Arcade Plus*

Ghost Hunter \$ 26/30
Pro Football \$ 26/30
Night Rally \$ 26/30
Baseball \$ 26/30
(cassette/disk)

Datamost*

Snack Attack \$ 22
Thief \$ 25
Casino \$ 34

On-Line Systems*

*Jawbreaker \$ 20
Crossfire \$ 24
Threshold \$ 31

Sirius Software*

Snake Byte \$ 24
Twerps \$ 24
Gorgon \$ 32
Sneakers \$ 24
Others 20% Off

Sir-Teck*

Galactic Attack \$ 24
Wizardry P.G. \$ 40
Wizardry K. of D. \$ 28

**VISA-MASTERCHARGE • ORDERS ONLY • CALL COLLECT (313) 642-1454
ALL OTHER INFORMATION (313) 644-8921**

For fast delivery, send certified check or money order. Specify hardware manufacturer, operating system, cartridge/cassette/disk system and format. Personal or company checks require one to three weeks to clear. Outside continental U.S. - add \$10 plus air parcel post. Add \$3.50 postage and handling per each item. Blue label \$3.00 additional per item. Michigan residents add 4% sales tax. Mastercharge - Visa add 3% and include expiration date. Prices subject to change without notice. All items subject to availability. * Mfgs. Trademark.

THE HAPPY COMPUTER

460 N. WOODWARD AVENUE
BIRMINGHAM, MI 48011
(313) 644-8921

*Sale prices are through September only!

Wayne Green Books

NEW
ARRIVALS

TEXTEDIT

a complete
word processing
system in kit
form.

by
Irwin Rappaport

A WAYNE GREEN
PUBLICATION

TEXTEDIT—A Complete Word Processing System in kit form

by Irwin Rappaport

TEXTEDIT is an inexpensive word processor that you can adapt to suit your needs, from writing form letters to large texts. It is written in modules, so you can load and use only those portions that you need. Included are modules that perform:

- right justification
- ASCII upper/lowercase conversion
- one-key phrase entering
- complete editorial functions
- and much more!

TEXTEDIT is written in TRS-80* Disk BASIC, and the modules are documented in the author's admirably clear tutorial writing style. Not only does Irwin Rappaport explain how to use TEXTEDIT, he also explains programming techniques implemented in the system.

TEXTEDIT is an inexpensive word processor that helps you learn about BASIC programming. It is written for TRS-80 Models I and III with TRSDOS 2.2/2.3 and 32K.

BK7387 \$9.97 Disk Available DS7387 \$19.97

ISBN 0-8806-050-6

Annotated BASIC—A New Technique for Neophytes.

BASIC programming was supposed to be simple—a beginner's programming language which was so near to English that it could be easily understood. But, in recent years, BASIC has become much more powerful and therefore much more difficult to read and understand. BASIC simply isn't basic anymore.

Annotated BASIC explains the complexities of modern BASIC. It includes complete TRS-80* Level II BASIC programs that you can use. Each program is annotated to explain in step-by-step fashion the workings of the program. Programs are flowcharted to assist you in following the operational sequence. And—each chapter includes a description of the new concepts which have been introduced.

Annotated BASIC deals with the hows and whys of TRS-80 BASIC programming. How is a program put together? Why is it written that way? By observing the programs and following the annotation, you can develop new techniques to use in your own programs—or modify commercial programs for your specific use.

Annotated BASIC Volume 1 contains Projecting Profits, Surveyor, Things to Do, Tax Shelter, Introduction to Digital Logic, Camelot, The Soundex Code, Deduction, Op Amp, Contractor Cost Estimating.

BK7384 \$10.95 ISBN 0-88006-028-X

AVAILABLE NOW!

Annotated BASIC Volume 2 contains Rough Lumber List, Trip Mileage, Flight Plan, OSCAR Data, SWR/Antenna Design, Supermaze, Petals Around the Rose, Numeric Analysis, Demons, Air Raid, Geography Test, Plumbing System Design.

BK7385 \$10.95 ISBN 0-88006-037-9

Order Both Volumes and Save! **BK738402 \$18.95**

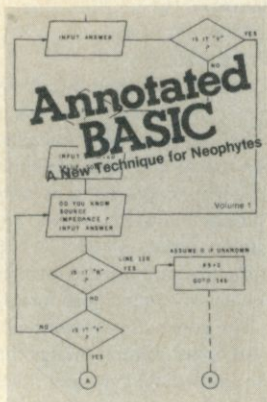

KILOBAUD CLASSROOM

Learn Digital
Electronics While
Building Your Own
Computer!

By George Young
and Peter Stark

KILOBAUD CLASSROOM—

A practical course in digital electronics

By George Young and Peter Stark

Learning electronics theory without practice isn't easy. And it's no fun to build an electronics project that you can't use. *Kilobaud Classroom* the popular series first published in *Kilobaud Microcomputing*, combines theory with practice. This is a practical course in digital electronics. It starts out with very simple electronics projects, and by the end of the course you'll construct your own working microcomputer!

Authors Young and Stark are experienced teachers, and their approach is simple and direct. Whether you're learning at home or in the classroom, this book provides you with a solid background in electronics—and you'll own a computer that you built yourself!

Kilobaud Classroom contains Getting the Ball Rolling, Gates and Flip-Flops Explained, J.K. Flip-Flops and Clocked Logic, PC Boards and Power Supplies, Hardware Logical Functions, Voltage, Current and Power Supplies, Transistors, Diodes and OP Amps, Pulses and More Pulses, Counters and Registers, Bus Traffic Control, ROM and RAM Memories, I/O Circuitry, Parallel and Serial I/O Ports, Computer I/O III, Computer I/O IV, Computer I/O V, Processor Connections, Finally... The Kilobaud Crescendo, Eproms and Troubleshooting, Expansions and Programming, Machine-Language Programming, Assembly-Language Programming, Connecting to the Outside World.

ISBN: 0-88006-027-1 **AVAILABLE NOW! BK7386 \$14.95**

THE NEW WEATHER SATELLITE HANDBOOK—

By Dr. Ralph E. Taggart WB8DQT—

Here is the completely updated and revised edition of the best-selling *Weather Satellite Handbook*—containing all the information on the most sophisticated spacecraft now in orbit. Dr. Taggart has written this book to serve both the experienced amateur satellite enthusiast and the newcomer. This book is an introduction to satellite watching, that tells you how to construct a complete and highly effective ground station. Not just ideas, but solid hardware designs and all the instructions necessary to operate the equipment are included. An entire chapter is devoted to microcomputers and the Weather Satellite Station, and for the thousands of experimenters who are operating stations, *The New Weather Satellite Handbook* details all the procedures necessary to follow the current spacecraft.

Weather Satellite contains Operational Satellite Systems, Antenna Systems, Weather Satellite Receivers, A Cathode Ray Tube (CRT) Monitor for Satellite Picture Display, A Direct-Printing Facsimile System for Weather Satellite Display, How to Find the Satellite, Test Equipment, Microcomputers and the Weather Satellite Station, Station Operations.

ISBN 0-88006-015-8 available now! **BK7383 \$8.95**



*TRS-80 and TRSDOS are trademarks of the Radio Shack Division of Tandy Corporation.

FOR TOLL-FREE ORDERING CALL 1-800-258-5473
WAYNE GREEN BOOKS ● PETERBOROUGH NH 03458

Use the order card or itemize your order on a separate piece of paper and mail to Wayne Green Books Attn: Sales ● Peterborough NH 03458. Be sure to include check or detailed credit card information. (Visa, Master Charge or American Express accepted.) No C.O.D. orders accepted. All orders add \$1.50 for the first book, postage and handling; \$1.00 each additional book; \$10.00 per book foreign air mail. Please allow 4-6 weeks after publication for delivery. Questions regarding your order? Please write to Customer Service at the above address.

Game Digest



Edited by Dan Muse

Pool 1.5

(Reviewed in Peelings II, April 1982)

System Requirements: Apple II, 48K bytes, game paddles

Manufacturer: Innovative Design Software, Inc., PO Box 1658, Las Cruces, NM 88004

Price: \$34.95

Comments: "Pool 1.5 is easy to play, fascinating to watch and extremely challenging," according to the review.

Four games can be selected: eight ball, rotation, straight pool and nine ball. The player selects the aim, speed and English he wants to put on the ball before each shot.

"The accuracy of the animation is a thing of beauty: the speed, color and clarity of the individual balls are totally unimpaired regardless of the number in motion at the time," according to the review.

One of the attractions of Pool 1.5 is that you control it. The game will indicate when you are doing something wrong, such as moving the ball across the demarcation line after a scratch, but it will not prevent you from doing it if you want to.

Pool 1.5 is "highly recommended," says the review. Reader Service number 433.

Computer Foosball

(Reviewed in Softline, May 1982)

System Requirements: Apple II, 48K bytes and disk

Manufacturer: Sirius Software, 10364 Rockingham Drive, Sacramento, CA 95827
Price: \$29.95

Comments: Foosball is back. The popular barroom and pool hall game has been computerized. The result is "amazing video simulation" and remarkably accurate animation, according to the review.

"Video foosball can be played with one, two or four players," according to the review. One slight difference between video foosball and the original game is that in the computerized version the rows of men move simultaneously; each row moved independently in the original game, the review says.

"As in the original, the pace often becomes frenetic: The ball zooms, wobbles and careens around the arena. Until the players develop some skill and timing, much of the scoring will result from the ball accidentally bouncing into the goals." Reader Service number 436.

Caverns of Mars

(Reviewed in Softline, May 1982)

System Requirements: Atari 400 or 800, disk only, 16K bytes

Manufacturer: Atari, Inc., Box 427, Sunnyvale, CA 94086

Price: \$39.95

Comments: "Ray Bradbury's Mars was never this much fun," says the review.

In Caverns of Mars the player starts off at the top of a large subterranean shaft. The object is to pilot a spaceship through the Martian caverns' twists and turns. The game consists of six levels progressing in difficulty as the shafts become trickier and the enemy ships more formidable.

The game offers several helpful features. "An option button allows the player to cycle immediately to any level for practice. The select button is a godsend; it allows the game to be placed on hold... very useful for the panic-stricken moment after destroying the cavern and discovering you must do it again," the review says.

"This game is great; you'll find it difficult to tear yourself away," according to the review. Reader Service number 435.

Swashbuckler

(Reviewed in Peelings II, May-June 1982)

System Requirements: Apple II, 48K, DOS 3.3 only

Manufacturer: DataMost, 9748 Cozycroft Ave., Chatsworth, CA 91311

Price: \$34.95

Comments: "Swashbuckler is a real-time animated duel between you, who control the swordsman, and various and sundry scurly, wretched, and generally vicious computer opponents," says the review.

The movements of your swordsman are controlled by the keyboard. You are first confronted by one pirate, but he proves to be not much of a challenge and soon you have opponents on both sides.

"The overall playability and challenge and atmosphere of the game are pleasing. It is a good piece of work." Reader Service number 446.

Hadron

(Reviewed in Peelings II, May-June 1982)

System Requirements: Apple II, 48K, DOS 3.2/3.3

Manufacturer: Sirius Software, Inc., 10364 Rockingham Drive, Sacramento, CA 95827

Price: \$34.95

Comments: "Hadron will provide you with the thrill of flying a space fighter and going into battle with it," the review says.

"The object of the game is to track enemy fighters back to their star base and destroy the base," according to the review. After destroying the enemy base your fuel and ammunition are replenished and you move to the next level of difficulty.

The view you see from within your spacecraft is "spectacular," according to the review. "For you to fully appreciate the view, a good quality color TV or color monitor is a must." Reader Service number 445.

Knight of Diamonds

(Reviewed in Softline, May 1982)

System Requirements: Apple II, Apple III (emulation mode), 48K, disk Wizardry: "Proving Ground of the Mad Overlord."

Manufacturer: Sirtech, 6 Main St., Ogdensburg NY 13669

Price: \$34.95

Comments: Knight of Diamonds is a sequel to Wizardry Proving Ground. KOD complements and enriches the popular Proving Ground game.

Knight of Diamonds is a six-level dungeon with several new twists. "There are individual quests and objectives on each level. The objects of these quests are required for the final quest on the sixth level."

"Unless you have a copy of Proving Ground, you cannot play KOD, much as you must learn to walk before you can run," the review says. Reader Service number 448.

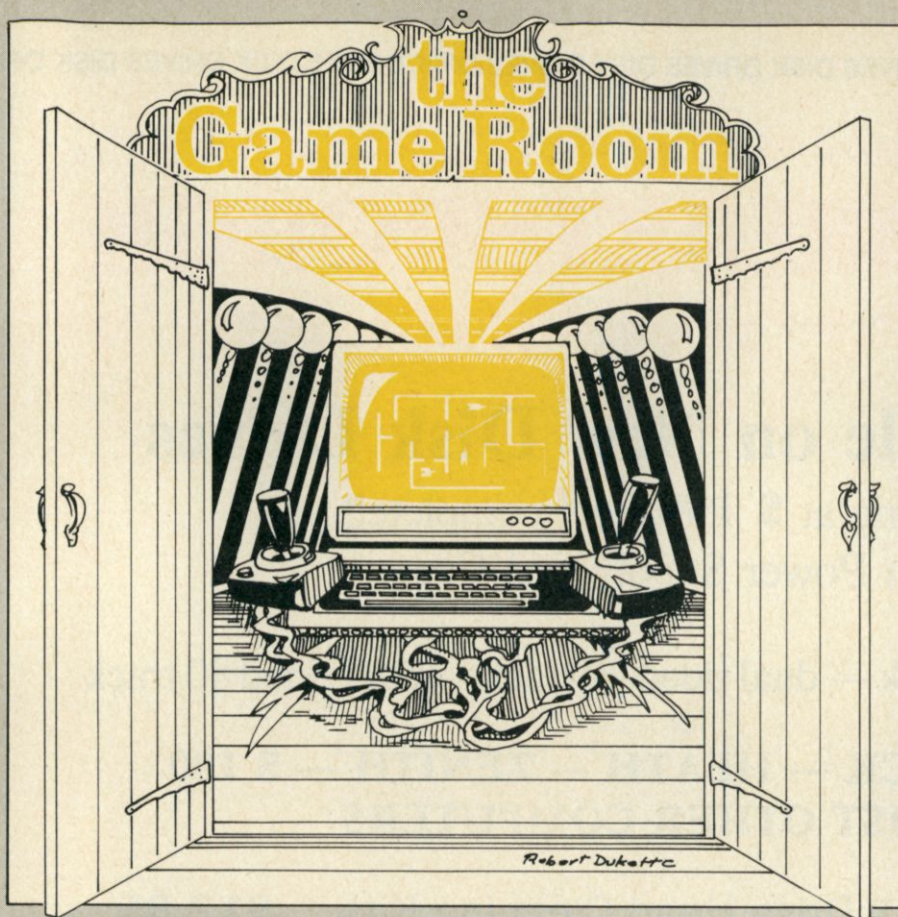

Welcome to the Game Room. Each month this section will feature Micro Game Digest, reviews of computer games currently available and articles dealing with the low-end, home/game computers—Atari, Vic. . . . So read on and let the games begin.

Track Attack

(Reviewed in Peelings II, May-June 1982)

System Requirements: Apple II, 48K, DOS 3.2/3.3

Manufacturer: Broderbund Software, Inc., 1938 Fourth St., San Rafael, CA 94901
Price: \$29.95

Comments: "The object of the game is to capture gold from a moving train without getting clobbered by either the train or the phantom watchman's car," the review says. The player can multiply the value of the gold by "jumping on the train, controlling it and capturing a second series of gold pieces," the review says.

"If you are looking for an easy arcade game, forget this one," according to the review. The main reason for the difficulty is the car. It cannot stop, move backward or turn around, so the player must always think ahead.

Also, the car does only what the player tells it to do. "If you don't give it a command, it will randomly pick a direction at an intersection.

"Initial reaction may be frustration followed either by disinterest or determination to master the game," the review says. Reader Service number 444.

Microwave

(Reviewed in Softline, May 1982)

System Requirements: Apple II or Apple III (emulation mode), 48K bytes and disk.

Manufacturer: Cavalier Computer, Box 2032, Del Mar, CA 92014
Price: \$34.95

Comments: Microwave is an innovative variation of the popular eat-the-dots games, according to the review.

The game features a teddy bear that you must maneuver through a series of complex mazes. The object of the game is to pick up various merchandise while avoiding exploding grenades and dodging "a gang of bizarre-looking aliens, so that you can proceed to the next maze."

Your teddy collects hammers, wrenches, calculators and other items scattered around the maze. The objects disappear as the bear passes over them. "As many as four aliens are in pursuit, planting grenades in the path the bear must take to pick up paraphernalia," the review says.

There are other features to the game that make it challenging. "If you've become bored with the more traditional games of this genre, this may be just what you're looking for." Reader Service number 437.

Minotaur

(Reviewed in Softalk, May 1982)

System Requirements: Apple II or Apple III in emulator mode, 48K and one disk drive.

Manufacturer: Sirius Software, 10364 Rockingham Drive, Sacramento, CA 95827
Price: \$34.95

Comments: "This arcade-style game puts you in the role of Theseus, hero of Greek mythology, whose task is to search for the Minotaur in a maze and kill the unholy wretch," the review says.

A maze has four levels connected by stairways. The Minotaur always resides on the fourth level of a maze, but various room monsters and Minotaur henchmen lurk in the hallways waiting, according to the review.

Things are available that the player can use to help in the search.

"Minotaur is a game with a lot of punch." Reader Service number 442.

Olympic Decathlon

(Reviewed in Micro, June 1982)

System Requirements: Apple II with 48K

Manufacturer: Microsoft Consumer Products, 10700 Northrup Way, Bellevue, WA 98004

Price: \$29.95

Comments: Olympic Decathlon is not for children. It requires coordination and timing, according to the review. It is "one of the most difficult games on the market."

"The program simulates all events of an actual decathlon," says the review. "Exceptional graphics and good instruction" are featured in Olympic Decathlon.

The documentation is well written and offers clues for strategy. Reader Service number 432.

Peeping Tom

(Reviewed in Softalk, May 1982)

System Requirements: Apple II or Apple III (emulation mode), 48K and one disk drive.

Manufacturer: Micro Lab, 2310 Skokie Valley Road, Highland Park, IL 60035
Price: \$35.95

Comments: "Peeping Tom is difficult and challenging, a good twist on an old theme," according to the review.

In this game you control a ship and you have an enemy that you must destroy; however, this foe is behind shuttered windows, the review says.

"As soon as you shoot an enemy, the portion of the window it was behind opens," the review says. Reader Service number 443.

Threshold

(Reviewed in Peelings II, April 1982)

System Requirements: Apple II, 48K, Disk II, DOS 3.2 and 3.3

Manufacturer: On-Line Systems, 36575 Mudge Ranch Road, Coarsegold, CA 93614
Price: \$39.95

Comments: "Threshold is highly recommended if you are a fan of shoot-'em-up space games," says the review.

The Threshold ship has a hyperwarp driver which will slow time and speed for other objects. "The energy consumption in this mode of operation is immense so it can only be used once," according to the review.

Some other constraints are that the lasers are very sensitive to heat. So if you fire them too quickly you will have a temporary power loss. There is also a limited fuel supply. You can refuel in mid-mission, but you must reach the rendezvous point to do this.

"The sound effects are great," says the review. This is "a superb arcade game." Reader Service number 434.

Tumblebugs

(Reviewed in Softline, May 1982)

System Requirements: Apple II, Apple II Plus, 48K bytes; Atari 400 or 800, 24K bytes, disk

Manufacturer: Datasoft, 19524 Business Center Drive, Northridge CA 91324
Price: \$29.95

Comments: In Tumblebugs you are trying to get through a complex maze, eating white dots along the way, while eight tumblebugs chase you. "Sound like Pac-man? You should have it so easy," the review says.

The mazes are difficult and the tumblebugs are relentless, according to the review. Also, since the program creates a random maze each time you play, you can't memorize the paths.

Technically, Tumblebugs is excellent and the animation is good, according to the review.

"Tumblebugs is a solid game. . . . It could stand some variety, but it certainly does not lack challenge," the review says. Reader Service number 431.

While Snake Byte doesn't offer massive waves of attacking aliens or flights through space, it is a fun and challenging game both for young people and adults.

Snake Byte

(Reviewed in Creative Computing, July 1982)

System Requirements: 48K bytes Apple, disk drive

Manufacturer: Sirius Software, 10364 Rockingham Drive, Sacramento, CA 95827
Price: \$29.95

Comments: The object of this game is to maneuver a snake through a series of rooms, eating apples along the way. When the snake eats ten apples he moves on to another room.

The game is not without danger. The player selects a game with either one, two or no perilous plums, according to the review. "These plums bounce around each room, and are deadly if they contact the head of the player's snake," the review says.

This might sound fairly easy; however, even though the snake is short when the game begins, its body grows with each apple eaten, the review says.

"While Snake Byte doesn't offer massive waves of attacking aliens or flights through space, it is a fun and challenging game, both for young people and adults," according to the review. Reader Service number 438.

Zork II

(Reviewed in Softline, May 1982)

System Requirements: Apple II, Apple III (emulation mode), Atari 400/800, IBM PC, NEC eight-inch CP/M; 32K bytes, disk.

Manufacturer: Infocom, 6 Faneuil Hall Marketplace, Boston MA 02109
Price: \$39.95

Comments: "Zork II takes up where Zork leaves off (although you need not have played Zork I to play Zork II)," according to the review.

The game places you deep in the land of Zork. "Here you'll meet the Wizard of Frobozz, a formidable foe who'll appear randomly to thwart your efforts at solving the many riddles in the game."

The adventure is complete with volcanoes, dragons, princesses, unicorns and a collection of other creatures. This is a totally text game; however, the descriptions are "fascinating and detailed," the review says.

"Zork II is an adventure fit for master adventurers; those of you who are new to adventuring may find the game more of a challenge than you bargained for," the review says. Reader Service number 447.

Circle 326 on Reader Service card.

Enjoy The SEXPLOSION



Bonus
For Charter
Subscribers!
10% Off On
All Dirty Book
Software

Subscribe Today Take a break from the space wars and shoot 'em ups. The Dirty Book will bring you the latest collection of bedroom programs and games geared to creative, joyful living and loving. Here's a great opportunity to chart your own course to greater intimacy and satisfaction in the months to come.



The Dirty Book

Read how your fellow computerists enjoy these zesty programs.

- French Post Cards • Bedtime Stories
- Dirty Old Man • Animated Comics
- Encounter • Interlude • Pornopoly
- Sex Disk • Softporn • Whatzee
- Wanna Play Footsie? • Zesty Zodiacs.
- Street Life • Love Quotient #9

Here's A New Contest You'll Love To Enter!

Submit your favorite micro-computer game program to the "Dirty Book" contest. You can win an expense-paid trip to fabulous New Orleans and enjoy the exciting French Quarter and all that jazz. The "Dirty Book" will expose your bedtime games and programs to thousands of prospective buyers. Write for full details.

Bourbon Street Press
3225 Danny Park, New Orleans
(Metairie), LA 70002 (504) 455-5330
(You must be of legal age to enter subscription)

Name _____

Company (if any) _____

Address _____

City _____

State _____ Zip _____

Charter Subscription Check enclosed

1 yr. 4 issues @29.95 COD — Company Only

Single issue @9.95 PO# _____

Dealer Inquiries or Call in Orders: Visa or _____

Bourbon St. Press (504) 455-5330 MC# _____

Signature _____ Expiration Date _____



Dueling Joysticks

Put more joy into your computing by adding two more joysticks to your VIC, thus letting up to three people play at the same time.

By Russell A. Grockett, Jr.

Remember the day you got your first program that used a joystick? How you went out, bought a pair (seems they're usually boxed in pairs) and came home to find out VIC has room for only one joystick?

"You mean only one person can play on VIC at a time? Oh well, I guess I've got a spare joystick. Maybe one of these days someone will come out with a way to add another joystick to VIC."

That day has arrived! For less than \$10 you can add connections for, not one, but two more joysticks, letting up to three people play at the same time! These connections are made through a plug-in slot, on the back of VIC, called the user I/O port.

What's a User Port?

VIC has several sockets (ports) for accessories like printers, cassette decks and extra memory (see Fig. 1). One of these sockets, called the user

port, allows VIC to be connected to the outside world. With it you can add a printer, modem, voice synthesizer or, as in our case, extra joysticks.

This user port is similar to the user port on the Commodore PET computer. PET owners had a problem worse than VIC owners—PET doesn't even have one joystick port available! Well, that didn't stop dedicated Space Invader fans. Early in PET history owners discovered the secrets of the user port. They quickly set up a standard for connecting a pair of joysticks to the user port. Then it was back to the more important task of obliterating those nasty invaders.

VIC owners can benefit from those earlier labors and add more joysticks to their machines, too!

How Do I Do It?

First, let's take a look at the VIC user port in Fig. 2. If you see the pins marked JOY0, JOY1, JOY2, etc., forget them! They are connected directly to the game port and your existing joystick. Instead, let's look at the pins marked PB0 to PB7.

These pins make up part of a parallel input/output port, which allows VIC to send or receive data one byte at a time. Since there are eight bits in a byte, the port has to have eight lines (or pins), one for each bit, in order to be parallel. Conversely, a serial port sends its data one bit at a time over one line. By grounding any combination of the eight lines, we can send VIC data that can be used in our program.

In order to ground those data lines we need switches. It just so happens that the Atari joystick has those switches! Each joystick has four direction switches and one push-button switch. By pushing the joystick, one or more of those switches are closed. Connect the direction switches so that each one closes the circuit between ground and one of the port data lines. Wire the push-button switches so that each one closes two circuits, instead of one. This setup lets you use two Atari joysticks on one parallel port.

To VIC, the user port looks like just another eight-bit memory location. By peeking at the memory location 37136, VIC reveals the status of the data lines as a number between 0 and 255. Normally, the port reads 255 (all bits are ones). When a data line is grounded, that bit becomes a zero, changing the number read by the peek. Decoding our new joysticks is done almost the same as decoding VIC's existing joystick.

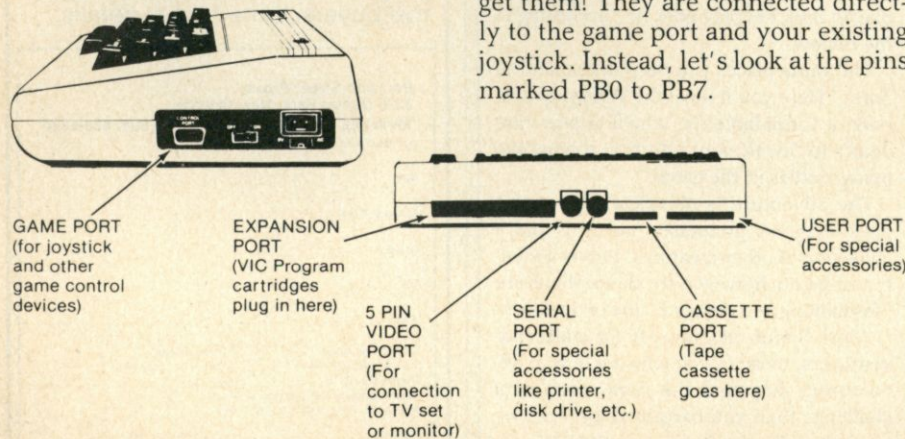

Fig. 1. VIC sockets to accommodate accessories.

Address correspondence to Russell A. Grockett, Jr., 401 Monument Road, #171, Jacksonville, FL 32211.

We Have It!.. At the best prices.

**Call For Super Value
On S-100 System With
Dbl. Dens. 8" Drives!**

**INTERTEC SUPERBRAIN II
Free! MicroSoft Basic 80**

Self-contained computer with dual disks and two RS232C ports. Complete with CP/M 2.2.
64K Double Density \$2099
64K Quad Density \$2495
64K Super Density \$2949
10 Meg. DDS Hard Disk \$2995

VIDEO TERMINALS

INTERTEC INTERTUBE III	749
ZENITH Z-19	729
SOROC IQ 120	649
SOROC IQ 130	595
SOROC IQ 135	749
SOROC IQ 135G	799
SOROC IQ 140	1149
HAZELTINE ESPRIT	CALL
1420	CALL
1500	CALL
1510	CALL
1520	CALL
TELEVIDEO 910C	CALL
912C	CALL
920C	CALL
925C	CALL
950C	CALL
TEXAS INST. 940 BASIC	1599
940 Package	2079
745 Portable Terminal	1399
745 Portable Terminal w/U/L/Case	1495

PRINTERS

ANADEX DP-9500	\$1349
DP-9501	1349
PAPER TIGER IDS-560G	1139
PRISM PRINTER IDS-80, w/o color	Call
IDS-80, w/color	Call
IDS-132, w/color	1695
NEC 3510, RO RS232C 35 CPS	1945
NEC 3530, RO, Centr. Inter. 35CPS	1945
NEC 7710, RO RS232C 55 CPS	2395
NEC 7720, KSR, RS232C 55CPS	2999
NEC 7730, RO, Centr. Inter. 55 CPS	2395
QUME	
Sprint 9/45, LTD. 45 CPS, RS232C	2119
C.I.TOH Pro Writer, Parallel	549
Serial and Parallel	629
DIABLO 630, RS232C, 55 CPS	2299
CENTRONICS 730-1, Parallel	399
730-3, RS232C	489
739-1 w/Graphics, Parallel	525
739-3B w/Graphics, RS232C	639
704-11, Parallel	1695
704-9, RS232C	1595
122G, Parallel, 120 CPS	949
EPSON	
MX80	489
MX80FT	589
MX100FT	789
RS232 Serial Interface	65
RS232/2K BufferInterface	125
Grafrax II	90
Apple Printer Interface	75
T1810 Basic, RS232C	1349
810 Basic, RS232C & Parallel	1395
810 w/full ASCII, vertical forms control compressed print	1599
820 RO, Basic	1645
820 KSR, Basic	1839

OKIDATA	
Microline 80	\$465
Tractor-feed option	59
Microline 82A	519
Microline 83A	849
Microline 84	1199

MONITORS

ZENITH-ZYM-121, 12" Green Phos.	\$125
AMDEK 100, 12"	139
100G, 12" Green Phosphor	149
300, 12" Green Phos., Hi. Res.	199
Color, 13"	359
Color II, 13", R.G.B. Hi Res.	799
Apple adapt. for R.G.B.	159
BMC, 12", Green Phosphor	169

**NORTH STAR
Call For Prices**

FLOPPY DISK SYSTEMS

MORROW DESIGNS	
Discus 2D, single drive DD	\$898*
Dual Discus 2D, dual drive DD	1549*
Discus 2 + 2, double sided DD	1239*
Dual Discus 2 + 2	2139
*Includes CP/M 2 + 2 and Microsoft Basic	

HARD DISK SUBSYSTEMS

MORROW DESIGNS	
Discus M-5 5 Meg.	\$1849*
Discus M-10 10 Meg.	3095*
Discus M-20 20 Meg.	4069*
Discus M-26, 26 Meg.	3795*
CORVUS 5 Meg.	3185
10 Meg.	4545
20 Meg.	5499

KONAN David 5 Meg.	2499
10 Meg.	3049
15 Meg.	3295
INTERTEC 10 Meg.	SPECIAL \$3195
*S-100 only w/CP/M 2 + 2 & Microsoft Basic	

**FLOPPY DISK CONTROLLER
BOARDS**

CROMEMCO 16FDC DD	\$499
NORTH STAR DD	479
MORROW Disk Jockey 2D, A&T	329
SD SYS. Versafloppy I, A&T	319
SD SYS. Versafloppy II, A&T	429
DELTA DD Disk Cont., A&T	345
CONDUCTOR DD, A&T	269
INTERSYSTEMS, FDC-2, A&T	439
TARBELL DD, A&T	445
SYSTEMS GROUP DD DMA	439

**ESCON CONVERSION FOR
IBM ELECTRIC**

Complete with microprocessor controller and power supply. Factory built. User installs solenoid assembly or it can be done at ESCON Factory.
 RS232 Serial & Parallel \$534
 Cable for above 25

PROM PROGRAMMERS

SSM PB1 Kit	\$152
SSM PB1, A&T	225

MODEMS

NOVATION CAT Acoustic Modem	\$149
D-CAT Direct Connect	155
AUTO-CAT Auto Ans.	219
APPLE CAT	329
USD 103 LP Direct Connect	175
103 JLP Auto Answer	209
DC HAYES MICROMODEM II (Apple)	299
MODEM 100 (S 100)	339
Smart Modem (RS 232)	239
Potomac Micro Magic (S 100)	339

**CALIFORNIA COMPUTER
SYSTEMS**

Z80 CPU Board	\$269
Disk Controller 2422, w/CP/M	359
16K Static, A&T	259
32K Static, A&T	399
64K Dynamic RAM	335
System 2210 w/64K, CP/M 2.2	1495

CPU BOARDS

(assembled unless noted)	
NORTHSTAR Z-80A (ZPB-A/A)	\$269
INTERSYSTEMS (MPU-80)	349
SSM CB1 8080, A&T	214
CB2, Z-80, A&T	289
CB2, Z-80, Kit	219
DELTA Z-80 with I/O	289
SD SYSTEMS, SBC-100, A&T	349
SBC-200, A&T	399
SYSTEMS GROUP Z-80 with I/O	419

MEMORY BOARDS

NORTHSTAR 16K RAM	\$299
HRAM 64K	589
HRAM 32K	419
CROMEMCO 16KZ	419
CROMEMCO 64KZ	595
MEMORY MERCHANT	
16K Static, 4MHz	159
64K Static, 4MHz	549
SYSTEMS GROUP	
<i>(Measurement Systems & Controls)</i>	
DM4800 48K Board	499
DM6400 64K Board	529
DMB6400 64K Board	595
INTERSYSTEMS 64K Dynamic	845

GODBOUT (A&T)

CPU Z	\$249
CPU 8085 88	359
RAM 20 30	359
RAM 17 64	675
RAM 21	1439
Interface 1	210
Interface 2	210
Disk 1	419
System Support 1	335
Enclosure 2 (Desk)	699
Enclosure 2 (Rack)	760

VIDEO BOARDS I/O Mapped

SD SYSTEMS	
VDB-8024, A&T	\$469
SSM VB2 I/O, Kit	169
VB2 I/O, A&T	229
MEMORY MAPPED	
VB1C, 16x64, Kit	152
VB1C, 16x64, A&T	206
VB3, 80 Char. 4MHz, Kit	359
VB3, 80 Char. 4MHz, A&T	419

APPLE BOARDS

CALIFORNIA COMPUTER	
7710A Asynchronous Ser Interface	\$129
7712A Synchronous Der Interface	149
7424A Calender Clock	99
7728A Centronics Printer Interface	99

MOUNTAIN HARDWARE

CPS Multifunction Board	\$199
Supertalker SD200	259
Romplus w/ keyboard filter	179
Romplus w/o keyboard filter	130
Keyboard filter ROM	49
COPYROM	49
Music System	459
ROMWRITER	149
Apple Clock	239
A/D-D/A	295
Expansion Chassis	625
VISTA	
8" Disk Controller (Apple II)	\$495

All prices, F.O.B. shipping point, subject to change. All offers subject to withdrawal without notice. Advertised prices reflect a 2% cash discount (order prepaid prior to shipment). C.O.D.'s and credits cards are 2% higher.

MiniMicroMart, Inc.

943 W. Genesee St. P.O. Box 2992K Syracuse, N.Y. 13220 (315) 422-4467 TWX 710-542-0431

Hardware

Use the PET standard joystick interface, shown in Fig. 4, when wiring to VIC. (There are several standard PET interfaces available; this is one of the most widely used.)

The hardware needed for this project consists of the following: a DB-25P connector; a 12-position, 24-contact edge connector with .156 inch pin spacing, such as CINCH 251-12-30-160; four 1N914 diodes (or equivalent); and, of course, two Atari-type joysticks. Since the DB-25P connector allows two joysticks to be plugged into it, the cost of separate DB-9P (the standard connector) is saved. Fig. 3 shows the pin layout for a typical Atari-type joystick.

The DB-25P may be wired to the edge connector by using Fig. 4. Pin numbers for the DB-25P are marked on the connector. The edge connector pins used by this project are on the bottom row of the connector and are lettered A to N. Note that the edge connector can be incorrectly plugged in upside down. There is no polarization, so be careful! It is advisable to mark the top of the connector "this side up" as a reminder.

Note the diodes connecting the push buttons to the user port. When a button is pressed, VIC's parallel port reacts as though the joystick is being pushed up and down simultaneously (a rather improbable condition!).

VIC can then be programmed to know that whenever it sees that condition, a button has been pushed. The diodes prevent the real up and down switches from closing both circuits. Be sure to observe the polarity of the diodes when installing them. The cathodes or banded ends connect to the joystick buttons (pins 14 and 22 on the DB-25P).

Software

The Basic subroutine in Listing 1 is designed as a general-purpose decoder for the two joysticks. It returns a value the same as the subroutine for the VIC game port as shown in the *VIC Programmers Manual*.

Just add this subroutine to any program when you want to use dual joysticks and GOSUB 9000 whenever you want to check the joysticks.

The DB-25P connector and the diodes should be available from local computer or electronics stores. The

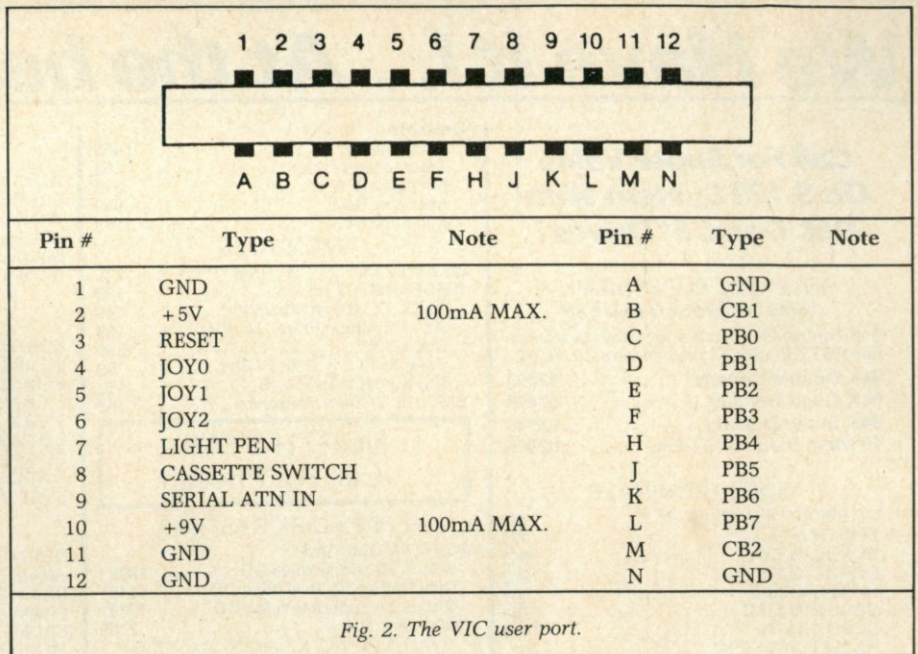

Fig. 2. The VIC user port.

edge connectors are a bit harder to find, though. One source for all of the connectors and joysticks, as well as programs using dual joysticks, is Rak Electronics, PO Box 1585, Orange Park, FL 32073. ■

Pin # Function

- | | |
|---|--------------|
| 1 | Up Switch |
| 2 | Down Switch |
| 3 | Left Switch |
| 4 | Right Switch |
| 5 | Not Used |
| 6 | Push Button |
| 7 | Not Used |
| 8 | Ground |
| 9 | Not Used |

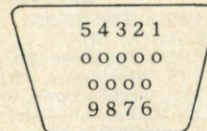

Fig. 3. Atari joystick pin layout.

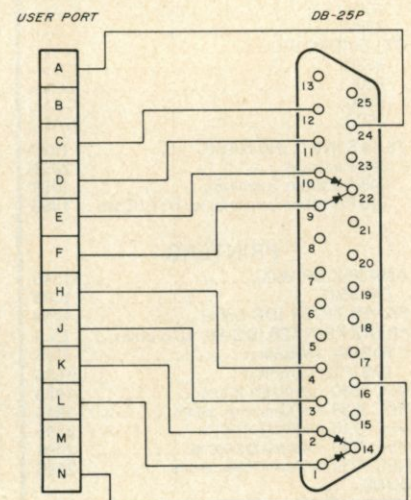

Fig. 4. DB-25P to edge connector wiring.

```

10 DIM JS(15): PC = 37136
20 FOR I=0 TO 15
30 READ JS(I)
40 NEXT I
50 DATA 0,0,0,0,0,-23,-21
60 DATA -22,0,21,23,22,0
70 DATA -1,1,0
100 REM * CHECK JOYSTICK
110 GOSUB 9000
120 PRINT J1;F1;J2;F2
130 GOTO 110
9000 P=PEEK(PC):J1=JS(P AND 15)
9010 J2=JS((0.0625*P)AND 15)
9020 F1=-((P AND 12)=0):F2=-((P AND 192)=0):RETURN

```

PC is the user port memory location.

J1,J2 are joysticks one and two, respectively.

F1,F2 are the fire buttons on the joysticks.

Listing 1. VIC joystick program.

DEALER DIRECTORY

El Monte, CA

Eagle II and M/ACOM-OSI business computer specialist. Serving greater Los Angeles area with all your business computer needs. In-house service, custom programming, terminals, printers, etc. Open 9 AM-6 PM. **Computer Challenge Corp., 3380 Flair Drive, El Monte, CA 91731.**

N. Hollywood, CA

Wholesale prices to dealers and computer club members! Anadex, Centronics, Corvus, Delta, Diablo, Epson, Godbout, Hayes, IDS, C. Itoh, Micro Pro, Mountain Computer, NEC, Novation, Okidata, Qume, TI, Televideo, Vector Graphic, Vista, Zenith and others. **Patio Computer Sales Co., Suite 204, 5451 Laurel Canyon Blvd., N. Hollywood, CA 91607. 762-0020.**

Nokomis, FL

We are the leading area computer store. We carry Cromemco, Apple, Vector Graphic; printers and terminals. We offer full software support including G/L, A/R, payroll and word processing. **Computer Centre, 909 S. Tamiami Trail, PO Box 130, Nokomis, FL 33555. 484-1028.**

Pasadena, MD

Altos, Apple, Osborne, Atari—systems, software, service. Not just another computer store! We're a full-service problem solving center for small businesses. **Computer Crossroads, Inc., 9143G Red Branch Rd., Columbia, MD; 8220 Ritchie Hwy., Pasadena, MD. 730-5513/647-7111.**

Lodi, NJ

Computer hardware: North Star, Zenith, Atari, CBM/PET, Qume, Epson and others. Software: EduWare, Professional Software, Zenith, North Star, Programma, Personal Software and others. Factory trained service dept. Books, magazines, etc. Full product line on display. **Comtek Electronics, Inc., Rt. 46 West, Lodi, NJ. 472-2440.**

Staten Island, Brooklyn, NY

Computer hardware: North Star, Zenith, Atari, CBM-PET, Qume, Epson and others. Software: EduWare,

Professional Software, Zenith, North Star, Programma, Personal Software and others. Factory trained service department. Books, magazines, etc. Full product line on display. **Comtek Electronics Inc., Staten Island Mall, Staten Island, NY. 698-7050; Coney Island Ave. and Ave. X, Brooklyn, NY. 332-5933.**

Akron, OH

Atari video game authorized independent servicer. Games serviced by factory trained technicians. Fast turnaround. Dealer inquiries invited. We stock genuine Atari game and joystick parts. **Greensburg Electronics, 2618 Massillon Road, Akron, OH 44312. 644-3178.**

Woodbridge, VA

Computer/word-processing systems for business, school, home. Software, disk drives, printers. Books, magazines, supplies. Authorized CBM/PET dealer, service. Consulting, training, maintenance contracts. MWF noon-8 PM, Saturday 9 AM-3 PM. **Virginia Micro Systems, Inc., 13646 Jefferson Davis Highway, Woodbridge, VA 22191. 491-6502. Washington Metro 643-1063.**

CLASSIFIEDS

Classified advertisements are intended for use by persons desiring to buy, sell or trade used computer equipment. No commercial ads are accepted.

Two sizes of ads are available. The \$5 box allows up to 5 lines of about 35 characters per line, including spaces and punctuation. The \$10 box allows up to 10 lines. Minimize use of capital letters to save space. No special layouts allowed. Payment is required in advance with ad copy. We cannot bill or accept credit.

Advertising text and payment must reach us 60 days in advance of publication (i.e., copy for March issue, mailed in February, must be here by Jan. 1). The publisher reserves the right to refuse questionable or inapplicable advertisements. Mail copy with payment to **Classifieds, Microcomputing, Peterborough, NH 03458.** Do not include any other material with your ad as it may be delayed.

For sale—Motorola Exorset 30 computer, 48K expandable to 56K; with MEX6850 ACIA card, MEX6816 16K RAM card, MEX 68PP1 EPROM prog.; software—XDOS, MBasic compiler, 6800,05,09 macro assemblers, editor, exorbug monitor and more. All for \$3000. Call Bob, 312-547-0611.

Computer magazine back issues: 9 titles, 124 issues, 1977-1982. Send stamped envelope for list. David Simmons, PO Box 7000-140, Redondo Beach, CA 90277.

Microcomputing, #1-#65; *Computing Teacher*, May 81-Oct. 81 (6); *Byte*, Dec. 77, Aug. 79-July 80 (13); *Output*, Mar. 80-June 81 (16); *Computer Decisions*, May 81-April 82 (12); *55-50 Computing*, Mar. 80-June 81 (8); *S-100 Microsystems*, Jan. 80-April 82 (VI#1-V3#2) (13); reasonable offers accepted—shipping extra. A. D. Choate, PO Box 32488, Louisville, KY 40232.

For sale or adoption: A 32K CBM/PET big keybd. computer (\$800); 4040 dual disks (\$800); 2022 printer (\$450); cassette (\$70); MTU visible graphics board (\$300); Toolkit; WP3; terminal software; JINSAM3.0; more than 100 programs. Package worth \$4500, will sell for \$2400 or as priced. Call Jerry, 313-763-4403 (days), 313-426-8690 (nights).

Complete 68000 system with 32K RAM, 16K monitor, parallel printer port, timer, cassette tape I/O, and auxiliary RS-232 port con-

ained in an H-19 professional terminal. Monitor includes a single-line assembler-disassembler along with a host of normal commands including a help command. Can operate the H-19 and aux. port in transparent mode. Excellent condition with all manuals only \$1750. R. L. Riggs, 2865 Akron, East Point, GA 30344.

For sale: genuine Radio Shack Level II ROMs, \$100. Signalman modem \$90, 16K Level II computer, \$500. Contact Frank Weatherford, Rt. 12, Hidaway Hill #36, Gray, TN 37615. 615-477-7202.

Wanted: TSC Miniflex DOS and disk at hex (7000-7FFF). Also SWTPC 8K memory board, MP8M. Steve Stanley, 1 Whitney Rd., Latham, NY 12110. 518-785-5089.

For sale: DEC LSI 11/2 (KD11HA) CPU card, \$350. KDF11 11/23 CPU w/MMU and 22 bit add., \$1350. KEV11 EIS/FIS for 11/03, 11/2, \$95. KEF11 FPP for 11/23, \$325. MSV11DD 64K mem., \$375. All in like new cond. More PDP8, PDP11, LSI-11 equip., write for full list. J. Simpson, Box 632, West Caldwell, NJ 07006. 201-335-6919 evenings/weekends.

ZX-80/81 users groups: Free newsletter and software available from the Z-WEST users group. No SASE. No money. Just your name or group address. Write Z-WEST, PO Box 2411, Vista, CA 92083.

Program Conversions

Microcomputing welcomes and encourages its readers to submit conversions of applications programs published in this magazine. You should send in conversions (a hard copy listing along with a cassette or disk) for the Apple, Atari, Commodore, Heath, IBM PC or Sinclair systems. We'll check it to see that it runs OK and prepare it for possible publication. You'll be sharing your efforts with thousands of other users, who'll be able to add another selection to their program libraries. Of course, you'll be rewarded handsomely for your efforts.

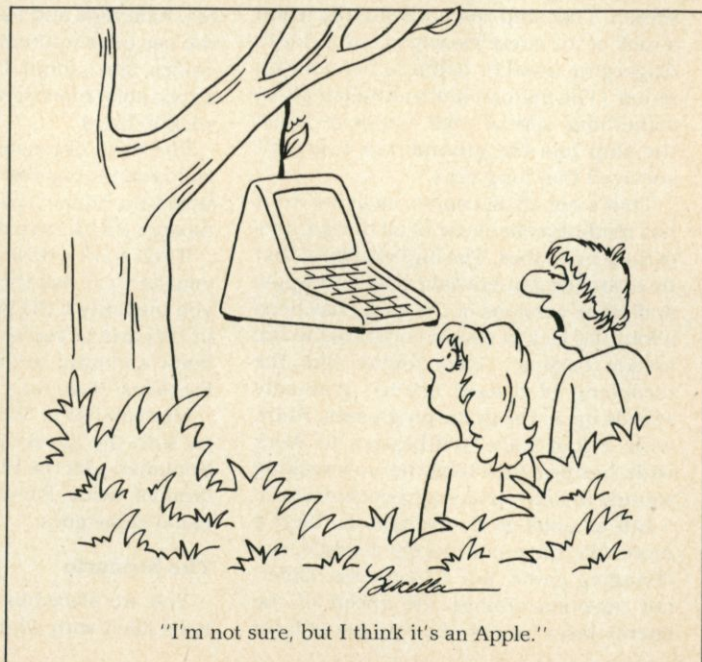



Invaders, Pac-Man Games Predominate

Edited by Dan Muse

Atari Space Invaders

The only "official"
Space Invaders game
for personal computers

At long last the sneers of Apple owners can be laid to rest. We Atari owners are now the proud possessors of the only "official" Space Invaders game for personal computers. All others, no matter how much they resemble the classic arcade game, cannot even legally be called Invaders. We have the real thing.

Actually, Invaders purists will probably be disappointed in the Atari Space Invaders. Though the game concept remains the same, the actual playing field has been modified considerably. Gone are the simple little black-and-white aliens. Yellow, red, aqua, white, blue and pink aliens in amazing animation descend on unprotected laser guns. (You get five guns instead of the old three.) The racks of aliens, rather than appearing all at once, emerge slowly from a rocket ship at the left of the screen. That ship descends slightly when a rack of the enemy is wiped out, prior to disgorging another batch to be exterminated. (The manual hints tantalizingly at something special that happens when the ship hits the ground, but I haven't survived that long yet.)

That's not all, of course; as usual Atari has made excellent use of all the features of their machines. The big complaint that most arcade gamers have had with Apple and other versions of the game has been about the lack of sound compared to the arcade original. That sound, like the throbbing of distant drums, gradually speeds up as the game progresses. Atari, with a four-voice synthesizer to work with, has provided those nerve-wracking sounds to help spoil your concentration.

But as good as this version is, there's more. We have not merely a single, unchanging game, but 12 versions. Different versions change the speed of the enemy laser beams, the number of laser

guns you have (the Atari term is "lives") and, most diabolical of all, whether or not the lasers of the enemy *home in on you*.

This is not a game you'll get tired of when you've figured out how to get the highest score (as is the case with Apple versions). In fact, the appearance of the "mystery ship" in this Atari version seems to be random.

At \$19.95 you'll want to add Atari Space Invaders to your game library. It's an easier game for kids to understand as well. Besides, think of all the quarters you'll save!

**William L. Colsher
Lisle, IL**

Snakman

A Pac-Man-type
Game for the
Commodore VIC-20

These days a computer just isn't a computer unless it can play Space Invaders, Asteroids and Pac-Man. Some scorn the use of computers as mere game machines, but, I admit, I love to sit in front of a good color monitor with a fresh new joystick in hand.

The thrill of mastering a game, while all too short, is great. You see, I'm a kid. I saved my money and bought the Commodore VIC-20 to play and write games.

If you want a review of a game, who do you turn to? Ask the kids! They can tell you instantly if the game is any good. So in this article you're hearing it from the horse's mouth, so to speak. Do you like Pac-Man? Read on.

Microdigital in Webster, NY, provides us with the latest version of Pac-Man—Snakman—for the VIC. In case you're unfamiliar with Pac-Man, here's how a usual game goes.

The Scenario

You are placed in a maze with all the halls filled with white dots and an occa-

sional gray dot. In the center of the maze is a chamber which contains four ghost-like creatures. At the start of the game these creatures are unleashed from their chamber in search of you.

Your mission is to eat all the white dots while evading the ghosts. To your advantage you have the gray colored dots. When you eat the gray dots, the ghosts turn white (you thought ghosts were white! No, these are colors) and do their best to get away from you, and for good reason! When the ghosts turn white, you have the opportunity to eat them.

The eaten ghosts return to the chamber and re-emerge ready to go after you again. They don't give up easily!

After about 15 seconds a long, low note is sounded to warn you that the ghosts will soon regain their colors and resume the chase after you. Points are scored for each white dot and ghost eaten.

You may also score bonus points by eating objects ranging from a star to a kettle. These objects appear randomly in a spot above the ghosts' chamber. While there is a certain risk in coming so close to the ghosts' home base, the points scored are well worth it. After eating a whole maze of dots, more dots appear and the ghosts get tougher. You are allowed to be eaten three times. That, ladies and gentlemen, is Snakman!

Mobility

Mobility is an important factor in a fast-paced game like Snakman. You must have excellent control to twist your way through the maze eating as many dots as possible while evading the ghosts.

Snakman may be played using either the keyboard or a joystick. Both provide good movement but the joystick is the easier of the two to use.

The game also has somewhat of a type ahead feature. That is, you may make a turn before you actually have another hallway to turn onto. This way you can develop a sort of rhythm in "snaking" your way through the maze.

Peripherals

Unlimited...

FANTASTIC PRICES!

OUR FAST SERVICE, PRODUCT SELECTION AND OUR CUSTOMERS' SATISFACTION MAKE US #1.

ZENITH

Z-89-48K	\$2299
Z-90-64K DO	\$2588
Z-19 Terminal	\$777
Z-121 Monitor 12"	\$149

ATARI COMPUTERS

Atari 800 16K	\$649
Atari 400	\$318
Atari Interface Module	\$174
Atari 810 Single Disk	\$444
Atari 830 Modem	\$166
Programmer	\$59
Entertainer	\$84
Star Raiders	\$34
16K Mem. Exp. for Atari	\$74
32K Mem. Exp. for Atari	\$114

NEC PRINTERS

7710/30 Spinwriter R/O	CALL
7720 Spinwriter KSR	CALL
3510/30 Spinwriter R/O	CALL

NEC DOT MATRIX

PC-8023	\$474
---------	-------

Call for prices on ribbons, etc.

MORE PRINTERS

Anadex 9500/9501	\$1295
Anadex DP-9000	\$1049
Okidata Microline 82A	CALL
Okidata Microline 83A	CALL
Okidata Microline 84	CALL
Tractor (OKI80 + 82 only)	\$60
Diablo 630	\$2044

MONITORS

Sanyo 12" GRN Phosphor	\$266
Sanyo 12" Black + White	\$239
Amdek 12" 300 GRN Phosphor	\$149
Amdek 12" Color I	\$319
Amdek Color II	\$779
NEC 12" GRN Phosphor	\$164
NEC 12" Color	\$344

EPSON PRINTERS

MX-80 w/Graphics	CALL
MX-80 FT (Friction + Tractor)	CALL
MX-100 (15" Carriage)	CALL

Call for prices on Ribbons, Cables and Interfaces

NEC-PC 8000 Series Microcomputer

PC-8001A Computer w/32K	\$888
PC-8012A w/32K + Exp. Slots	\$588
PC-8031A Dual Mini Disk	\$888
PC-8032A Add-on Mini Disk	\$777

Call for Software Prices

**FOR THE LOWEST
PRICE CALL
TOLL FREE
1-800-343-4114**

ORDERING INFORMATION

Our order lines are open 9AM to 6PM EST Monday thru Friday. Phone orders are welcome; same day shipment on orders placed before 10AM. Free use of Mastercard and VISA. Personal checks require 2 weeks clearance. Manufacturer's warranty included on all equipment. Prices subject to revision. C.O.D.'s accepted.

For service, quality and delivery call:

**PERIPHERALS UNLIMITED
(617) 655-7400**

62 N. Main St. • Natick, MA 01760

Playability

One of the nice features of the original Pac-Man is that its ghosts are actually smart. They love nothing better than closing in on you for a tasty meal (and another quarter). Snakman is no exception. As the levels of play increase, the ghosts become increasingly harder to evade. It's very well done and almost like the original.

Graphics and Sound

The game screen and characters are obviously composed of the program-mable-character set available on the VIC. The maze graphics are fairly coarse, but the overall picture presented is clean and causes little eye strain (great for those all-night marathons!).

Sound is another thing. During the entire game a high-pitched warbling sound accompanies your every move. I found that after an hour of play it was necessary to turn the volume down or off. A satisfying Ka-Chunk occurs when you eat a white dot or ghost.

Conclusion

Considering the memory available on an unexpanded VIC (5K bytes), Snakman is a programming feat. The price of \$16.95 is a bargain compared to versions for other computers, which cost upward of \$30. The game is fun to play and definitely a good buy.

(Microdigital, 752 John Glenn Blvd., Webster, NY 14580.)

Bill Price
Mountain Lakes, NJ

Galactic Chase

An addicting
Arcade game for
The Atari 400/800

Those of you who have enjoyed the arcade game GALAXIAN will have a blast, literally, with Galactic Chase.

It runs in 16K for the Atari 400/800 computer and uses joysticks. One or two players can play. It is written in machine language and is very fast and smooth on the screen. The graphics and sound are extremely well done and make very good use of the Atari graphic capabilities.

Loading Galactic Chase is very simple. Just insert the tape into the 410 recorder and push the play button, then turn on the computer, while holding down the start button, and hit return.

The tape will load in about two minutes. The sound you hear is higher pitched than the usual CLOAD tape because, according to the manufacturer, of the higher recording speed.

You start the game by selecting one of the two options: number 1 for novice

commanders (like myself) or number 2 for more experienced galactic commanders. Number 2 speeds up the attackers and slows down your missiles.

When the screen first appears it looks like the game will be as easy as shooting fish in a barrel. Your command ship on the bottom of the screen has horizontal movement. There is a fleet of assorted aliens on the top of the screen, Space Invaders style, but that is where the easy part ends.

After you take your first few shots at those poor unsuspecting alien ships, they break out of formation and dive bomb your ship, dropping bombs and trying to crash into your command ship.

You must move back and forth across the screen firing your missiles to get the alien ships. If you sit still too long they will home in on you (remember, this is a computer you are dealing with). If you must crash into an alien ship make sure you hit it head on and your magnetic repellers will destroy it.

The ships are worth more points when they are attacking than they are in formation. Should your command ship be destroyed, you have two more in reserve which will pop onto the screen at the demise of the previous ship.

If you manage to destroy all of the alien ships in the fleet, you are rewarded with another invasion. The more fleets you destroy the more difficult they get until you reach the 31st (31st???) level where an invisible ray disables your missile launcher and slows down your missiles.

This game also keeps track of your high score on the screen so you have something to shoot for.

This game is very addicting, so be prepared for marathon sessions. I would recommend this game for all people from eight to 80 who enjoy arcade-type games. *(Spectrum Computers, 26618 Southfield, Southfield, MI 48076.)*

Richard D. Prill
Pompano Beach, FL

Munchkin and Invaders

Enjoyable Heath games
For those
Up to the challenge

First, I must say that these games should not be played by those with faint hearts, or weak forearms. Also, those with only a few hours to spend defending the world from an invading horde of outer space creatures, or avoiding little creatures with voracious appetites probably should not attempt these games.

What, one might ask, are the two games being reviewed here? Munchkin is

another name for Pac-Man, while Invaders pits the player against an unending horde of invading creatures, presumably from outer space. Whatever their origin, they have an unlimited reserve. They march across the screen in ranks five deep by ten wide. Their formation is perfectly aligned and dressed, to the envy of any military man.

At first glance, the immediate conclusion would be that the formation would make the creatures easier to destroy. Not so, because it is possible for the defender's projectile to go completely through the invader's ranks without scoring a single hit.

The defender starts with three cannons. Each time the invaders score a hit on the defender's cannon, it is lost. Lose three cannons without replenishing them and the fate of the world is in the hands of the invaders. More on how to replenish the cannon later. The defender is able to (and in fact must) move the cannon back and forth across the bottom of the screen (on the 24th line), firing at the invaders by hitting the space bar on the keyboard and hiding behind a set of four barriers. The barriers eventually succumb to the incessant barrage of invaders' bombs and are destroyed. The degree of barrier destruction is dependent on the defender's proficiency: destroy the invaders before they destroy all three cannons or completely destroy the barriers.

While they exist, the barriers allow the defender to stop for a brief respite (scratch an itchy nose which has never before itched, flex stiff fingers, etc.) or hide briefly against the invaders' bombs. Unfortunately, the barriers do not afford enough protection to allow the defender much of a respite. Some players I have seen playing the game actually prefer to destroy the barriers with their own cannon, thereby offering a clear field of fire at the invaders.

The creatures march across the screen, dropping bombs which eventually destroy the defender's barriers. At indeterminate intervals, the invaders advance one row toward the defender. All the while, the invaders drop bombs which usually strike the protective barriers, although not always. All too often, the bombs hit the defender's cannon. As in baseball, three strikes and you're out. Unlike baseball, it is possible to increase the number of "outs" the defender is allowed.

As the invaders march across the screen, they are accompanied at random intervals by a mother ship which moves from left to right across the top of the screen. The point value of the ship varies, depending, it would appear, on the number of invaders on the screen. The minimum value is 50 points, while the maximum seems to be 250. The higher values

PRICES YOU CAN'T BEAT!...

COMPUTERS	
SUPER BRAIN II	\$1935
PMC-81	\$565
LNW-80	\$1295
LNW-80 II CP/M	\$2195
FRANKLIN ACE	\$1475
NEC 8001	\$729
TIMEX/SINCLAIR ZX-81	CALL
PRINTERS	
EPSON	
MX-80 W. GRAFTRAX	\$435
MX-80/FT. FRICT FEED	\$559
MX-100 GRAFTRAX	\$729
CENTRONICS	
739 SER OR PAR	\$499
SMITH CORONA	
TP-1	\$695
C-I TOH	
PROWRITER	\$459
F-10 40 CPS SER OR PAR	\$1365
F-10 55 CPS SER OR PAR	\$1615
F-10 TRACTOR FEED	\$195
DISK DRIVES	
BASF	\$215

TANDON	
100-1 S/S 40 TRACKS	\$235
100-2 D/S 40 TRACKS	\$319
100-3 S/S 80 TRACKS	\$319
100-4 D/S 80 TRACKS	\$375
848 8" S/S	CALL
848 8" D/S	CALL
AM ELECTRONICS	
5 MEG HARD DISK W. DOS FOR TRS-80	\$1675
EXPANSIONS INTERFACES	
LNW RESEARCH	
BARE BOARD	\$69
GOLD CONNECTORS ADD	\$25
METAL CASE	\$55
ASSM / TST / GOLD / CASE	\$349
MICRO DESIGN	
MDX-2 BARE BOARD	\$69
MDX-3 BARE BOARD	\$69
MDX-2 ASSM/TST	\$349
MDX-3 ASSM/TST	\$299
ALUM CASE FOR MDX-2	\$45
NEC	
PC8012 I/O	\$485
PC8031 DUAL DISK	\$695

CRT MONITORS	
AMDEK	
BLK & WHT 100	\$99
GREEN 300G	\$159
COLOR	\$359
COLOR RGB	\$439
TECO	
BLK & WHT	\$99
GREEN	\$129
COLOR RGB	\$429
MOD CARD FOR RGB	\$35
MODEMS	
MICROPERIPHERAL	
ATARI I	\$189
APPLE	\$285
TRS-80	\$195
TRS-80 COLOR	\$189
ANCHOR AUTOMATION	
SIGNALMAN	\$85

MICH. RES. ADD 4% TAX — POSTAGE. CALL FOR CHARGES. PRICES ARE DISCOUNTED FOR CASH & MONEY ORDERS (NON CERTIFIED CHECKS ALLOW 2 WEEKS TO CLEAR). MASTERCARD AND VISA ADD 3%. NO C.O.D. - NO PICK UPS; WE ARE MAIL ORDER ONLY.

VESPA COMPUTER OUTLET

16727 Patton, Detroit, MI 48219, (313) 538-1112

Circle 172 on Reader Service card.

Scotch® Diskettes

Rely on Scotch® diskettes to keep your valuable data safe. Dependable Scotch diskettes are tested and guaranteed error-free. The low abrasivity saves your read/write heads. They're compatible with most diskette drives.

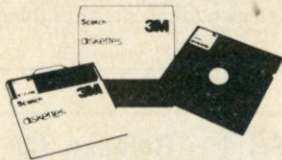

(800)235-4137

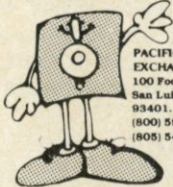

PACIFIC EXCHANGES
100 Foothill Blvd
San Luis Obispo, CA
93401. In Cal. call
(800) 592-5935 or
(805) 543-1037

Dealer Inquiries Invited

Circle 359 on Reader Service card.

80 CHARACTER VIDEO BOARD — S-100

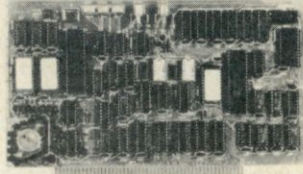

All This on ONE BOARD:

- Keyboard port with TYPE-AHEAD buffer
- 8275 CRT controller with light pen port
- Two 2716's — program & character rom's
- Optional 2716 for CHARACTER GRAPHICS
- All screen & keyboard ram
- SIMULTANEOUS I/O or Memory mapped
- Z-80 MPU — 2 or 4 Mhz system clock
- Easy to adapt Software
- Uses only EAST-TO-GET parts
- Use in any S-100 system
- 696 Bus Compliance: D8 M16 I8 T200
- Build for less than \$200

Now includes crystal & heat sink.

Introducing The VDB-A

Bare board with Documentation \$49.50
+ \$2 s&h (Ill. res. add 6% tax)

Simpliway PRODUCTS CO. Dept KM-9
P.O. Box 601, Hoffman Estates, IL 60195
Dealer Inquiries Invited
312/359-7337

Circle 128 on Reader Service card.

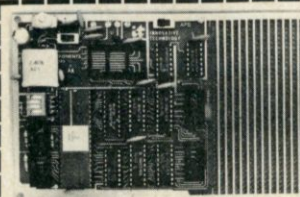

MC6801 APPLICATIONS PROTOTYPE BOARD

The APB is a small board which supports the MC6801 family of microcomputers. It is described in Motorola's application note AN799. A typical 6801 member contains an enhanced 6800 processor, 2K bytes of ROM, 128 bytes of RAM, a 16-bit programmable timer, parallel I/O, and a serial communications interface. In addition to the resources of the 6801, the APB provides an additional 2K bytes of EPROM (TMS2716), 2K bytes of RAM (2114L), and a full duplex RS-232 interface. It also supports special versions such as the 6801G1 with its LILBug™ monitor, and provides on-board programming of the 6801 EPROM version.

The APB is an excellent educational aid which allows for evaluation and familiarization of 6801 family members. It is great for prototype development. Since the nuts and bolts are already in place, the designer need only add the necessary interface circuits for a particular application. It can also be used as a simple cost-effective dedicated controller for those limited quantity applications.

Besides being so practical, it is a fun little board. Order yours today!

™ TM of Motorola Semiconductor Products, Inc.

APB-1 Bare board with documentation	\$ 19
APB-2 Above assembled with all parts less microcomputer and memory	\$ 69
APB-3 Above with MC6801G1 and LILBug manual	\$109
APB-4 Above with four 2114L RAMs	\$129

For the \$5-30 Bus
AD-68A A/D Converter - 8 channels, 8 bit, 0-2.5V input, 6ms conversion time — \$39 A&T
CI-68A Control Interface - 8 opto-isolated inputs, 8 reed relay outputs — \$79 kit, \$98 A&T

Terms: Check, MO, VISA, or MC. In US and Canada add \$3 per item for shipping. Others add \$7 per item. US funds only. TX add 5% tax. Shipped from stock to two weeks.

INNOVATIVE TECHNOLOGY
510 Oxford Park
Garland, TX 75043 (214) 270-8393

Circle 60 on Reader Service card.

More than just an Assembler/Editor!

It's a Professionally Designed Software Development System

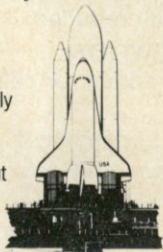

MAE
for
PET
APPLE
ATARI
\$169.95

Blast off with the software used on the space shuttle project!

- Designed to improve Programmer Productivity.
- Similar syntax and commands — No need to relearn peculiar syntaxes and commands when you go from PET to APPLE to ATARI.
- Coresident Assembler/Editor — No need to load the Editor then the Assembler then the Editor, etc.
- Also includes Word Processor, Relocating Loader, and much more.
- Options: EPROM Programmer, unimplemented opcode circuitry
- STILL NOT CONVINCED? Send for free spec sheet!

Eastern House

3239 Linda Dr
Winston Salem, N.C. 27106
(919) 924 2889 (919) 748 8446

Subscription Problem?

Microcomputing does not keep subscription records on the premises, therefore calling us only adds time and doesn't solve the problem.

Please send a description of the problem and your most recent address label to:

Microcomputing Subscription Dept.
PO Box 981
Farmingdale, NY 11737

Circle 332 on Reader Service card.

PRICE BREAK

**EPSON
MX-80
CARTRIDGE RIBBONS**

**\$9.95
EA.**

\$107.46 per dozen
Minimum Order 3 Ribbons
Price Includes Shipping
We accept Mastercard and Visa

CHECK-MATE™
P.O. BOX 103, RANDOLPH, MA 02368
Call Toll Free - 1-800-343-7706
In Massachusetts - 617-963-7694

seem to be available only when there are a lot of creatures on the screen, thereby protecting the ship and preventing a clean shot.

The defender scores by hitting the invaders and as many mystery ships as possible. As stated earlier, there are five ranks of invaders. The closest rank has a point value of ten points per invader. Since it is more difficult to hit the far ranks, they have an increased point value (30 points).

As the defender's score is increased, there are certain point levels at which the number of cannons left is increased by one. Since I am not, and do not profess to be, a proficient Invaders player, I cannot say with certainty at exactly what levels the cannons are replaced (besides, that would detract from the excitement of playing a new game). I can only say that one must reach 1500 points before a cannon is replaced. Fifteen hundred points may not sound like much, but with those bombs raining on the defender, a rank novice will require a few games before the first cannon is replaced. Of course if no cannons have been lost thus far, the defender receives an extra one.

After the initial 1500 point level, it seems that the next cannon is replaced about 500 points later, and in increments

of 500 points. It is a testimony to the degree of concentration required that I was unable to accurately determine at what point level the defender is given more cannons.

After one horde of invaders is defeated, another appears on the screen. The de-

I personally
cannot play
Invaders very long
before I get
a headache

fender's barriers are partially rebuilt. I suppose that if the game lasted long enough, the defender might be left with no protective barriers at all. It should be noted that the invaders release their bombs more rapidly with each new generation of creatures.

Thus, a combination of a greater frequency of bombs and fewer barriers to hide behind, coupled with forearm fatigue, conspire to doom the defender. If the defender is able to record a new high point score, the program asks for the de-

fender's name, which is written to a disk file, there to be recorded for eternity or until someone beats that score. At the bottom of the screen is the high point score to beat. No fair using a text editor to edit the point file!

One feature of the game which should appeal to anyone who has ever fired a weapon at a moving target is the fact that the defender's projectiles simulate a ballistic trajectory: they have a finite time of flight relative to the target's speed. Thus, it is necessary to lead the target in order to hit it. That is especially true for the farther targets. Adding to the challenge is the fact that the creatures increase their speed across the screen as they get closer to the barriers. Therefore, it is necessary to judge the speed of the creature at which you are aiming each and every time. I can see that this game would have definite benefits in reinforcing marksmanship training which teaches leading the target.

Munchkin is less violent in the sense that no one is being shot at or bombed; one must simply avoid being eaten by a pack of Munchkins (a.k.a. Pac-Men) with voracious appetites. As there is probably no kid of any age who has not seen, or at least heard of, Pac-Man, there is little need to go into much detail of the object

Circle 68 on Reader Service card.

"MR EDIT"™
VIDEO TEXT EDITOR
The INTELLIGENT Workhorse of CP/M & MP/M



PARTIAL COMMAND SUMMARY:

- Cursor Control: up, down, left, right, by character, line, word, paragraph, screen, buffer, user defined tab stops. User definable visible Tab and Carriage Return characters.
- Delete character, word, line (all bidirectional), to EOL, BOL; area or paragraph.
- Ability to select any area of text for various operations.
- Automatic word wrapping at any column; automatic paragraph alignment.
- List on Line Printer by line or area.
- Extensive search/replace capabilities; supports up to 10 simultaneous search/replace arguments. Local or Global search capability.
- Disk Directory and File Deletion, both selective by user, drive, and file, with wildcards allowed. Selective Disk Reset.
- HORIZONTAL window control for easy editing of material wider than the screen.
- Primary and secondary files for both input and out, if needed.
- UNSURPASSED edit command files and iteration macros.
- Indent level control for structured programming.
- On-the-fly definition of a function key as any combination of commands.

FEATURING:

- User Configurable to ANY non-memory mapped VDT with at least 12 lines of 64 columns.
- Fully screen oriented with comprehensive status information line.
- User defined mix of commands and function keys.
- Function keys are LIVE and screen of text stays in place and in view EVEN IN COMMAND MODE.
- Cursor is maintained in proper text location EVEN IN COMMAND MODE.
- Can reference any combination of Drives and User Numbers.
- English language commands: can be abbreviated as desired.
- Insert, Overwrite, and Command modes.
- Can be used Standalone or with a Text Processor for Word Processing.
- Handles MBASIC Line continuation.
- User may specify ANY command as a command key via configuration program. Special prefix keys (also definable) allow multi-function command keys. THE ENTIRE COMMAND KEY STRUCTURE, BOTH LAYOUT AND CONTENT, IS USER-CONFIGURABLE.

ONLY \$119.95 with complete documentation and installation instructions. Manual is available separately for \$15.00 (Tn residents add 6.75% sales tax). VISA and MasterCard welcome. Order today by letting us know the disk format desired. Free technical summary available on request.

MRc **Micro Resources Corporation**
6922 Harding Road, Suite 117-A
Nashville, Tennessee 37221
615-352-4605

Dealer inquiries welcome.
CP/M and MP/M are trademarks of Digital Research, Inc.
MR EDIT is a trademark of Micro Resources Corporation.

Circle 82 on Reader Service card.



MICROSTAT® - Release 3.0
MICROSTAT® + baZic® = PERFORMANCE

The best just got better! MICROSTAT has been the leader in the statistics field for microcomputers since 1979, and the new release 3.0 outperforms and is noticeably faster than previous versions. Just a few of the features include:

- GREATER ACCURACY**
BCD with up to 14 digit precision;
- PROGRAM ENHANCEMENTS**
Missing data capabilities and many more;
- FASTER EXECUTION**
Calculation time greatly reduced;
- DYNAMIC FILE ALLOCATION**
Data can be inserted, added, or deleted;
- SPECIAL PRICE:**
For a limited time get MICROSTAT plus baZic complete with program disk and documentation for each for \$395.00, save \$50.00!

The MICROSTAT - baZic version requires: a Z80 CPU, CP/M™ and 48K of memory. Available formats: 8" SD disk or 5¼" North Star only. Check with your dealer for other formats. Also available for: Microsoft's Basic-80™, North Star DOS and IBM. For more information, call or write:

ECOSOFT INC.
P.O. Box 68602
Indianapolis, IN 46268-0602
(317) 255-6476

MICROSTAT is a registered trademark of ECOSOFT, INC.
baZic is a registered trademark of MICROMIKES, INC.
CP/M is a registered trademark of DIGITAL RESEARCH
Basic-80 is a registered trademark of MICROSOFT

of the game. Munchkin seems to have very accurately captured the Pac-Man action, less, of course, the sound effects.

There are books on the market which detail a strategy to outsmart the little creatures. I have not purchased one, so I cannot vouch for whether or not the same strategy will work here. I have noticed, however, a very welcome flaw in the game. If the player puts his creature in one of the blind areas of the maze and does not move him, the creatures we are trying to eat become disoriented. This lets the player retire to the refrigerator for a much-needed libation, stretch, or to soothe an upset spouse who wishes to hear a human voice rather than incessant beeps from the terminal.

Munchkin uses slightly different graphics characters than Pac-Man. When the Munchkin has acquired a power point, the face of the Munchkin changes, and a prompt appears at the bottom of the screen. This signifies that the Munchkin is able to eat the bad guys. The prompt at the bottom of the screen is difficult to see because of the concentration required, but the face change of the Munchkin partly compensates for that.

Both games have the same scorekeeping methods, and offer the opportunity to better one's score or try to beat another's.

The instructions which accompany the disk (dual formatted for HDOS and CP/M on the same disk) are excellent. They even tell how to modify the game to create different versions (change the speed of play, change what the creatures look like, what the maze looks like, etc). In the event that the player wishes to change the graphics, such as the appearance of the creatures, a graphics editor, such as The Software Toolworks' ED-A-SKETCH, is required.

Both games pit the player against himself, and therein lies the appeal. Because the highest score attained is displayed on the 25th line, it is always there as a reminder that improvement is possible.

Both games use graphics extensively. Invaders, by its very nature, uses more graphics. The creatures are constantly moving, which means that each creature must be drawn in one position, left there for a predetermined period of time, then erased and moved to the next position. Because of the relatively low data rate of the H-19 terminal (compared to the repaint rate of the graphics), the screen appears to tear from time to time.

I personally cannot play Invaders very long before I get a headache, although my experiences do not seem to be universal in that respect. Forearm fatigue, men-

tioned earlier, is a result of having to keep the fingers of the right hand poised above the right-hand keypad, ready to press any of the arrow keys to move the cannon or creature left or right, or in the case of Munchkins, up or down. I have found that my nerves become rather frayed also. Therefore, for me at least, the games are not relaxing if played for more than half an hour at one sitting.

I must say in all honesty that I have thoroughly enjoyed reviewing these two video games from The Software Toolworks. My two-and-a-half-year-old daughter takes great delight in sitting on my lap, pounding on the keyboard space bar, and shouting, "I got one!" when playing Invaders. While I would not recommend playing them as a steady diet, they certainly have their place in any well stocked library of home computer programs.

Invaders is catalogue number 214; Munchkin is catalogue number 217. Both cost \$19.95 plus \$2 per order for shipping and handling. Both will run on any H-8/H-17/H-19 system or any H/Z-89 running HDOS or CP/M.

(The Software Toolworks, 14478 Glorietta Drive, Sherman Oaks, CA 91423.)

J.C. Hassall
Blacksburg, VA

Circle 249 on Reader Service card.

APPLE SPEAKS INTELLIGENTLY!

The people who dared to teach Atari to talk are again challenging the microcomputer establishment with the VOICEBOX Speech Synthesizer for Apple. This low cost intelligent peripheral can speak thousands of words unassisted, generated directly from its firmware ROM dictionary located on its plug-in card. This means that speech, with variable intonation and speed, can be used in any of your apple programs without ever having to bother loading a disk. And, in case you want to expand your dictionary to include unusual words or words in foreign languages, you can easily define them with our 64 phonemes and store them by the thousands on one of the six special dictionaries provided for on our disk.

In addition your VOICEBOX for Apple can be easily coded to sing on key with uniform barlengths and you can store (record) your songs on disk, retrieving and modifying sections whenever you want. With the disk system, you'll also enjoy an educational random sentence generator and graphic speech animation! The VOICEBOX for Apple will run on 32K Apple II with Applesoft or Apple II Plus systems equipped with sixteen-sector disk drives. VOICEBOX for Apple comes with loudspeaker and disk. The Alien Group also makes a less expensive VOICEBOX for Apple with all features (including expandable disk dictionary), but excluding firmware ROM and singing capability. Speaker is optional on this unit.



For Atari users, the VOICEBOX for 16K and up Atari plugs directly into the serial port. No extra cables are needed and no speaker is needed since the speech comes directly over your TV monitor. This unit has all speech synthesis features except singing and firmware ROM.

AL-3001 VOICEBOX for Apple. With firmware ROM, singing capability and speaker \$215.00
AL-3501 VOICEBOX for Apple. Without firmware ROM, singing capability and speaker \$139.00
AL-4001 Speaker for AL-3501 (the AL-3501 will also work with any other speaker) \$15.00
AL-5001 VOICEBOX for Atari \$169.00

All mail orders are on a 10 day moneyback guarantee if you're not completely satisfied. When ordering enclose check or money-order or state VISA or MASTERCARD number. Send mail orders to:

THE ALIEN GROUP or Telephone orders
27 West 23rd Street from 10 AM to 6 PM
Dept. MC-3 New York time
New York, New York 10010 (212) 924-5546

ALSO AVAILABLE AT LEADING COMPUTER STORES
THROUGHOUT THE WORLD.

A Quick and Dirty Input Port

Convert an unused ROM space to add another input port to a single board computer.

By Ladimer S. Nagurney

While adapting a single board computer to an instrumentation system, I needed an additional eight-bit input port. Although I could have added another PIA using the expansion capabilities of the board, I searched for a simpler means of expanding. Lacking on-board wire-wrapping area or additional IC space I wondered if some of the unused programmable read-only memory (PROM) space could be converted into an input port.

The spare on-board ROM socket was for one of the generic, byte-wide ROMs (2316, 2332) or EPROMs (2708, 2716) that use +5 V and

ground. Except for the number of address lines, they have identical pinouts (Table 1). Replacing the ROM with tri-state buffers gated by the ROM chip enable provides a port that takes up a lot of address space, but no additional board space. Tri-state buffers, such as the Octal 74LS240 (inverting) or 74LS241 (non-inverting), can be used to buffer the input data.

Because I wanted the system to be

one-board and was unsure of the driving capabilities of the bus, I did not want to extend the bus. A 20-pin DIP socket was mounted on top of a 24-pin DIP header attached by short bare wires (see Table 2). This assembly was plugged into the ROM socket. A cable of nine wires for the data plus ground was attached to the input pins of the buffer and routed to a connector on the computer enclosure. After testing, the space between the socket and the header was potted with five-minute epoxy to insure both mechanical stability and electrical insulation.

The port is enabled whenever a read operation to the address space of the ROM occurs. For example, if the ROM was a 2716 located beginning at A000 this would be any address between A000 and A7FF. Any instruction that reads from these memory locations may be used to input data.

This idea can be used with any system that has an extra ROM socket or on the ROM board of a larger system. Even if the memories do not use only +5 V and ground, this idea may be used. For example, with a 1702 board all you have to do is provide a separate ground connection. ■

	2316B 2K×8	2332 4K×8	2708 1K×8	2716 2K×8
01	9	9	9	9
02	10	10	10	10
03	11	11	11	11
04	13	13	13	13
05	14	14	14	14
06	15	15	15	15
07	16	16	16	16
08	17	17	17	17
CE*	20	20	20	20
+5 V	24	24	24	24
GND	12	12	12	12

*Note: CE is enabled when low.

Table 1. Pinout diagrams for popular memory chips.

Function	ROM pin	74LS240(1)pin
CE*	20	1,19
D1	9	5
D2	10	7
D3	11	9
D4	13	12
D5	14	14
D6	15	16
D7	16	18
D8	17	3
+5 V	24	20
GND	12	10
D1 in		15
D2 in		13
D3 in		11
D4 in		8
D5 in		6
D6 in		4
D7 in		2
D8 in		17

Table 2. Pinout connections for ROM socket assembly.

Address correspondence to Ladimer S. Nagurney, 123 Burlington St., Providence, RI 02906.

Disk Drive for Apple \$319.95

Diskettes

PREMIUM DISKETTES - Jade

We proudly put our name on these high quality diskettes -

5 1/4" Diskettes, Box of Ten		
MMD-5110103	SS, SD, 01S	\$29.00
MMD-5111003	SS, SD, 10S	\$29.00
MMD-5111603	SS, SD, 16S	\$29.00
MMD-5120103	SS, DD, 01S	\$31.00
MMD-5121003	SS, DD, 010	\$31.00
MMD-5121603	SS, DD, 16S	\$31.00

8" Diskettes, Box of Ten		
MMD-8110103	SS, SD, 01S	\$31.00
MMD-8120103	SS, DD, 01S	\$39.00
MMD-8220103	DS, DD, 01S	\$48.00

BARGAIN DISKETTES

MMD-5110105	5 1/4" SS, DD, 01S	\$19.95
MMD-5220105	5 1/4" DS, DD, 01S	\$32.95
MMD-8110105	8" SS, SD, 01S	\$24.95
MMD-8120105	8" SS, DD, 01S	\$32.95
MMD-8220105	8" SS, DD, 01S	\$35.95

Video Monitors

HI-RES 12" GREEN - Zenith

15 MHz bandwidth 700 lines/inch, P31 green phosphor, switchable 40 or 80 columns, small, light-weight & portable.

VDM-201201 List price \$189.95 \$129.95

12" GREEN SCREEN - NEC

20 MHz bandwidth, P31 phosphor ultra-high resolution video monitor with audio.

VDM-561200 List price \$289.95 \$199.95

12" COLOR MONITOR - NEC

High resolution color monitor with audio.

VDC-651212 Color monitor \$389.95

NEC-1202D RGB color monitor \$999.95

13" COLOR MONITORS - BMC

18 MHz RGB & composite video color monitors.

VDC-421320 13" RGB Color \$329.95

VDC-421310 13" Composite video \$299.95

VDX-420090 RGB card for Apple \$149.95

COLOR MONITORS - Amdek

Reasonably priced color video monitors.

VDC-80130 13" Color I \$379.95

VDC-801320 13" Color II \$894.95

IOV-2300A DVM board for Apple \$199.95

AMBER or GREEN MONITORS - Jade

High resolution 18 MHz compact video monitors.

VDM-751210 12" Amber phosphor \$149.95

VDM-751220 12" Green phosphor \$139.95

VDM-750910 9" Amber phosphor \$149.95

VDM-750920 9" Green phosphor \$139.95

Modems

SIGNALMAN - Anchor

Direct-connect automatic answer/originate selection, 300 Baud full duplex, Bell 103, includes RS-232 cable

IOI-5600A Signalman \$98.50

SMARTMODEM - Hayes

Sophisticated direct-connect auto-answer/auto-dial modem, touch-tone or pulse dialing, RS-232C interface, programmable

IOI-5400A Smartmodem \$248.95

IOK-1500A Hayes Chronograph \$218.95

IOI-2010A Micromodem II \$328.95

IOI-1100A Micromodem 100 \$368.95

EPROM Erasers

ULTRA-VIOLET EPROM ERASERS

Inexpensive erasers for industry or home.

XME-3100A Spectronics w/o timer \$69.50

XME-3101A Spectronics with timer \$94.50

XME-3200A Economy model \$39.95

Single User System

THREE BOARD SET - SD Systems

4 MHz Z-80A CPU, 64K RAM (optional 256K), serial I/O port, parallel I/O port, double density disk controller, CP/M 2.2 & manual set, system monitor, control & diagnostic software. Includes SBC-200, 64K ExpandoRAM II, VorsaFloppy II, & CP/M 2.2 - all boards are assembled & tested.

Board set with 64K of RAM \$1095.00

Board set with 256K of RAM \$1295.00

Apple II Accessories

16K RAM CARD - for Apple II

Expand your Apple to 64K, 1 year warranty

MEX-16700A Save \$125.00 !!! \$69.95

ADD-ON DISK DRIVE - for Apple II

Inexpensive direct replacement for Apple Disk II, works with Apple II controller as first or second drive.

MSM-123200 Add On Drive \$319.95

MSM-123100 Controller \$94.95

Z-80 CPU CARD - for Apple II

Two computers in one, Z-80 & 6502, more than doubles the power and potential of your Apple, includes Z-80 CPU card CP/M and complete manual set.

CPX-62800A A & T with software \$249.95

8" DISK CONTROLLER - Vista

New from Vista Computer, single or double sided, single or double density, compatible with DOS 3.2/3.3, Pascal, & CP/M 2.2, Shugart & Qume compatible

IOD-2700A A & T \$499.95

2 MEGABYTES for Apple II

Complete package includes: Two 8" double-density disk drives, Vista double-density 8" disk controller, cabinet, power supply, & cables, DOS 3.2/3.3, CP/M 2.2, & Pascal compatible.

1 MegaByte Package Kit \$1495.00

1 MegaByte Package A & T \$1695.00

2 MegaByte Package Kit \$1795.00

2 MegaByte Package A & T \$1995.95

APPLE-CAT - Novation

Software selectable 1200 or 300 baud, direct connect, auto-answer/auto-dial, auxiliary 3-wire RS232C serial port for printer.

IOI-5232A Save \$50.00!!! \$325.95

VISION 80 - Vista Computer

80 column x 24 line video card for Apple II, 128 ASCII characters, upper and lower case, 9 x 10 dot matrix with 3 dot descenders, standard data media terminal control codes, CP/M Pascal & Fortran compatible, 50/60 Hz

IOV-2400A Vista Vision 80 \$299.95

CPS MULTICARD - Mtn. Computer

Three cards in one! Real time clock/calendar, serial interface, & parallel interface - all on one card.

IOX-2300A A & T \$179.95

HI-RES GRAPHICS CARD - Genie

Intelligent printer interface and control card allows full high resolution graphics and screen dumps.

IOP-2405A Genie for Epson \$119.95

IOP-2410A Genie for Okidata \$119.95

IOP-2415A Genie for NEC/C. Itoh \$119.95

Power Strips

ISOBAR - GSC

Isolates & protects your valuable equipment from high voltage spikes & AC line noise, inductive isolated ground, 15 amp circuit breaker, U.L. listed

EME-115103 3 socket \$39.50

EME-115105 4 socket \$49.50

EME-115100 8 socket \$54.50

EME-115110 9 socket rackmount \$74.50

Single Board Computer

SUPERQUAD - Adv. Micro Digital

Single board, standard size S-100 computer system, 4 MHz Z-80A, single or double density disk controller for 5 1/4" or 8" drives, 64K RAM, extended addressing, up to 4K of EPROM, 2 serial & 2 parallel I/O ports, real time interrupt clock, CP/M compatible.

CPC-30800A A & T \$724.95

IOX-4232A Serial I/O adapter \$29.95

Z-80 STARTER KIT - SD Systems

Complete Z-80 microcomputer with RAM, ROM, I/O, keyboard, display, kludge area, manual, & workbook.

CPS-30100K Kit with workbook \$299.95

CPS-30100A A & T with workbook \$469.95

AIM-65 - Rockwell International

Complete 6502 microcomputer with alphanumeric display, printer, keyboard, & instruction manual.

CPK-50165A 1K AIM-65 \$424.95

CPK-50465A 4K AIM-65 \$474.95

SFK-74600008E 8K Basic ROM \$64.95

SFK-64600004E 4K assembler ROM \$43.95

SFK-74600020E PL/65 ROM \$84.95

SFK-74600010E Forth ROM \$64.95

SFK-74600030E Instant Pascal \$99.95

PSX-030A Power supply \$64.95

ENX-000002 Enclosure \$54.95

SPECIAL PACKAGE

4K AIM-65, 8K Basic, power supply, & enclosure

Special Package Price \$649.95

S-100 EPROM Boards

PROM-100 - SD Systems

2708, 2716, 2732 EPROM programmer with software.

MEM-99520K Kit with software \$189.95

MEM-99520A A & T with software \$249.95

PB-1 - SSM Microcomputer

2708, 2716 EPROM board with on-board programmer.

MEM-99510K Kit with manual \$154.95

MEM-99510A A & T with manual \$219.95

EPROM BOARD - Jade

16K or 32K uses 2708 or 2716 EPROMs, 1K boundary.

MEM-16230K Kit w/o EPROMs \$79.95

MEM-16230A A & T w/o EPROMs \$119.95

S-100 Video Boards

SPECTRUM COLOR - CompuPro

Full-function color graphics board, up to 8 colors, 256 x 192 graphics, parallel I/O port, 8K RAM.

IOV-1870A A & T \$348.95

IOV-1870C CSC \$398.95

MICROANGELO - Scion

Ultra-high-resolution 512 x 480, 256 color or black & white S-100 video board

IOV-1500A A & T \$999.95

S-100 MotherBoards

ISO-BUS - Jade

Silent, simple, and on sale - a better motherboard

6 Slot (5 1/4" x 8 1/2")

MBS-061B Bare board \$19.95

MBS-061K Kit \$39.95

MBS-061A A & T \$59.95

12 Slot (9 1/4" x 8 1/2")

MBS-121B Bare board \$29.95

MBS-121K Kit \$69.95

MBS-121A A & T \$99.95

18 Slot (14 1/2" x 8 1/2")

MBS-181B Bare board \$49.95

MBS-181K Kit \$99.95

MBS-181A A & T \$139.95

ACTIVE TERMINATOR - CompuPro

A true mother's helper.

TSX-100A A & T \$59.45

Prices may be slightly higher at our retail locations. Please call the store nearest you for local price and availability.

CompuPro Boards on Sale

S-100 CPU Boards

8086/8087 - CompuPro

16 bit, 8 or 10 MHz 8086 CPU with provisions for 8087 & 80130.

CPU-70520A 8 MHz 8086 A & T	\$624.95
CPU-70520C 8 MHz 8086 CSC	\$764.95
CPU-70530A with 8087 A & T	\$1224.95
CPU-70530C with 8087 CSC	\$1455.95

8085/8086 - CompuPro

Both 8 & 16 bit CPUs, standard 8 bit S-100 bus, up to 8 MHz, accesses 16 Megabytes of memory.

CPU-20510A 6 MHz A & T	\$398.95
CPU-20510C 6/8 MHz CSC	\$497.95

CPU-Z - CompuPro

2/4 MHz Z80A CPU, 24 bit addressing.

CPU-30500A 2/4 MHz A & T	\$279.95
CPU-30500C 3/6 MHz CSC	\$374.95

SBC-200 - SD Systems

4 MHz Z-80A CPU with serial & parallel I/O, 1K RAM, 8K ROM space, monitor PROM included.

CPC-30200A A & T	\$399.95
------------------	----------

THE BIG Z - Jade

2 or 4 MHz switchable Z-80 CPU board with serial I/O, accommodates 2708, 2716, or 2732 EPROM, baud rates from 75 to 9600.

CPU-30201B Bare board w/manual	\$35.00
CPU-30201K Kit with manual	\$149.95
CPU-30210A A & T with manual	\$199.95

CB-2 - SSM Microcomputer

2 or 4 MHz Z-80 CPU board with provision for up to 8K of ROM or 4K of RAM on board, extended addressing, IEEE S-100, front panel compatible.

CPU-30300K Kit with manual	\$229.95
CPU-30300A A & T with manual	\$274.95

2810 Z-80 CPU - C.C.S.

2 or 4 MHz Z-80 CPU with serial I/O port & on-board monitor PROM, front panel compatible.

CPU-30400A A & T with PROM	\$289.95
----------------------------	----------

2820 Z-80 DMA CPU - C.C.S.

4 MHz Z-80 CPU board with 2 serial I/O ports & Centronics parallel I/O port, separate data & status ports, DMA daisy chain compatible.

CPU-30420A A & T with manual	\$569.95
------------------------------	----------

S-100 Disk Controllers

DISK 1 - CompuPro

8" or 5 1/4" DMA disk controller, single or double density, single or double sided, 10 MHz.

IOD-1810A A & T	\$449.95
IOD-1810C CSC	\$554.95
SFC-52506580F 8" CP/M 2.2 for Z-80	\$174.95
SFC-52506586F 8" CP/M 2.2 for 8086	\$299.95
SFO-54158000F Oasis single user	\$499.95
SFO-54158002F Oasis multi-user	\$849.95

VERSAFLOPPY II - SD Systems

Double density disk controller for any combination of 5 1/4" and 8" single or double sided, analog phase-locked loop data separator, vectored interrupts, CP/M 2.2 & Oasis compatible, control/diagnostic software PROM included.

IOD-1160A A & T with PROM	\$359.95
SFC-55009047F CP/M 2.2 with VF II	\$99.95

2242 DISK CONTROLLER - C.C.S.

5 1/4" or 8" double density disk controller with on-board boot loader ROM, free CP/M 2.2 & manual set.

IOD-1300A A & T with CP/M 2.2	\$399.95
-------------------------------	----------

DOUBLE D - Jade

High reliability double density disk controller with on-board Z-80A, auxiliary printer port, IEEE S-100, can function in multi-user interrupt driven bus.

IOD-1200B Bare board & hdwr man	\$59.95
IOD-1200K Kit w/hdwr & stwr man	\$299.95
IOD-1200A A & T w/hdwr & stwr man	\$359.95
SFC-59002001F CP/M 2.2 with Double D	\$99.95

S-100 Memory Boards

256K RAMDISK - SD Systems

ExpandoRAM III expandable from 64K to 256K using 64K x 1 RAM chips, compatible with CP/M, MP/M, Oasis, Cromemco, & most other Z-80 based systems, functions as ultra-high speed disk drive when used with optional RAMDISK software.

MEM-65064A 64K A & T	\$474.95
MEM-65128A 128K A & T	\$574.95
MEM-65192A 192K A & T	\$674.95
MEM-65256A 256K A & T	\$774.95
SFC-55009000F RAMDISK stwr CP/M 2.2	\$44.95
SFC-55009000F RAMDISK with EXRAM III	\$24.95

128K RAM 21 - CompuPro

128K x 8 bit or 64K x 16 bit static RAM board, 12 MHz, 24 bit addressing.

MEM-12810A A & T	\$1609.95
MEM-12810C CSC	\$1794.95

64K RAM 17 - CompuPro

64K CMOS static RAM board, 10 MHz, low power less than 4 watts, DMA compatible, 24 bit addressing.

MEM-64180A 64K A & T	\$549.95
MEM-64180C 64K CSC	\$698.95

64K RAM 16 - CompuPro

32K x 16 bit or 64K x 8 bit low power static RAM board, 10 MHz, 24 bit addressing.

MEM-32180A RAM 16 A & T	\$598.95
MEM-32180C RAM 16 CSC	\$698.95

64K STATIC RAM - SSM

IEEE 696/S-100 standard, up to 6MHz/8 Bit, 12MHz/16 Bit, 24 Bit extended addressing, disable-able in 2K increments

MEM-64300A A & T	\$499.95
------------------	----------

64K STATIC RAM - Mem Merchant

64K static S-100 RAM card, 4 to 16K banks up to 8 MHz.

MEM-64400A 64K A & T	\$499.95
----------------------	----------

2065 64K RAM - C.C.S.

4 MHz bank port/bank byte selectable, extended addressing, 16K bank selectable, front panel compatible.

MEM-64565A 64K A & T	\$349.95
----------------------	----------

2066 64K RAM - C.C.S.

64K RAM board with bank and block select switching functions for Cromemco Cromix & Alpha Micro.

MEM-64566A 64K A & T	\$424.95
----------------------	----------

64K EXPANDORAM II - SD Systems

Expandable RAM board from 16K to 64K using 4116 RAM chips.

MEM-16630A 16K A & T	\$344.95
MEM-32631A 32K A & T	\$364.95
MEM-48632A 48K A & T	\$384.95
MEM-64633A 64K A & T	\$399.95

MEMORY BANK - Jade

4 MHz S-100 bank selectable expandable to 64K.

MEM-99730B Bare board w/manual	\$49.95
MEM-99730K Kit with no RAM	\$179.95
MEM-32731K 32K kit	\$199.95
MEM-64733K 64K kit	\$249.95
Assembled & Tested	add \$50.00

32K RAM 20 - CompuPro

32K static RAM, up to 10 MHz, disable-able in 4K banks, bank select or 24 bit addressing.

MEM-16180A 16K A & T	\$259.95
MEM-16180C 16K CSC	\$324.95
MEM-24180A 24K A & T	\$324.95
MEM-24180C 24K CSC	\$384.95
MEM-32185A 32K A & T	\$384.95
MEM-32185C 32K CSC	\$449.95

16K STATIC RAM - Mem Merchant

4MHz lo-power static RAM board, IEEE S-100, bank selectable, addressable in 4K blocks, disable-able in 1K segments extended addressing.

MEM-16171A 16K A & T	\$149.95
----------------------	----------

S-100 I/O Boards

SYSTEM SUPPORT 1 - CompuPro

Real time clock, three 16 bit interval timers, dual interrupt controllers(15 levels), up to 4K EPROM/RAM, RS-232C serial channel, provision for 9511A/9512 math chip.

IOX-1850A SS1 A & T	\$359.95
IOX-1850C SS1 CSC	\$459.95
IOX-1855A with 9511 A & T	\$554.95
IOX-1855C with 9511 CSC	\$654.95
IOX-1860A with 9512 A & T	\$554.95
IOX-1860C with 9512 CSC	\$654.95

INTERFACER 1 - CompuPro

2 serial I/O ports 50-19.2K baud.

IOI-1810A A & T	\$218.95
IOI-1810C CSC	\$288.95

INTERFACER 2 - CompuPro

3 parallel, 1 serial, & interrupt timer.

IOI-1820A A & T	\$218.95
IOI-1820C CSC	\$288.95

INTERFACER 3 - CompuPro

5 or 8 channel serial I/O board for interrupt driven multi-user systems up to 250K baud.

IOI-1835A 5 port A & T	\$558.95
IOI-1835C 5 port CSC	\$628.95
IOI-1838A 8 port A & T	\$628.95
IOI-1838C 8 port CSC	\$749.95

INTERFACER 4 - CompuPro

3 serial, 1 parallel, 1 Centronics parallel.

IOI-1840A A & T	\$314.95
IOI-1840C CSC	\$414.95

MPX - CompuPro

Multi-use, I/O multiplexer & interrupt controller with on-board 8085A-2 CPU & 4K or 16K of RAM.

IOI-1875A 4K MPX A & T	\$444.95
IOI-1875C 4K MPX CSC	\$534.95
IOI-1880A 16K MPX A & T	\$584.95
IOI-1880C 16K MPX CSC	\$674.95

I/O-8 - SSM Microcomputer

Eight software programmable serial I/O ports, 110 - 19.2K Baud, ideal for multi-user systems

IOI-1018A A & T	\$469.95
-----------------	----------

I/O-5 - SSM Microcomputer

Two serial & 3 parallel I/O ports, 110-19.2K Baud

IOI-1015A A & T	\$289.95
-----------------	----------

MPC-4 - SD Systems

Intelligent 4-port serial I/O card, on-board Z-80A, 2K RAM, 4K PROM area, on-board firmware, fully buffered, vectored interrupts, four CTC channels, add to SD Board set for powerful multi-user system

IOI-1504A A & T w/software	\$495.00
----------------------------	----------

I/O-4 - SSM Microcomputer

2 serial I/O ports plus 2 parallel I/O ports.

IOI-1010B Bare board w/manual	\$35.00
IOI-1010K Kit with manual	\$179.95
IOI-1010A A & T with manual	\$249.95

2830 6 PORT SERIAL - C.C.S.

Six asynchronous RS-232C serial I/O ports with programmable baud rates.

IOI-1040A A & T with manual	\$529.95
-----------------------------	----------

2710 4 PORT SERIAL - C.C.S.

Four RS-232C serial I/O ports with full handshaking.

IOI-1060A A & T with manual	\$319.95
-----------------------------	----------

2719 2 SER & 2 PAR - C.C.S.

Two RS-232C serial I/O ports plus two 8 bit parallel I/O ports.

IOI-1080A A & T with manual	\$349.95
-----------------------------	----------

Prices may be slightly higher at our retail locations. Please call the store nearest you for local price and availability.

Printer & Disk Drive Sale

Dot Matrix Printers

NEW EPSONS with GRAFTRAX-plus

Epson has improved and upgraded their best selling line of printers to include their new GRAFTRAX-plus graphics package. Features now include: 9 x 9 matrix, bi-directional/logic seeking, line spacing to n/216, programmable forms length and horizontal tabs, skip over perf., italics fonts, international symbols, superscript/subscript, normal, emphasized, double-strike, and double-emphasized print, underlining, line drawing graphics, 60/120 DPI bit image, software reset, adjustable right margin, and true back space.

MX-80 with GRAFTRAX-plus 80/132 column, 80 CPS, adjustable pin feed, parallel interface.
PRM-28080 MX-80 w/GRAFTRAX-plus \$479.95

MX-80FT with GRAFTRAX-plus same as MX-80 with friction feed and pin feed.
PRM-28082 MX-80FT w/GRAFTRAX-plus \$559.95

MX-100 with GRAFTRAX-plus 132/232 column, correspondence quality, up to 15" paper, friction feed & adjustable pin feed, 18 x 18 dot matrix, 80 CPS.
PRM-28100 MX-100 w/GRAFTRAX-plus \$754.95

PRA-27084 Serial interface \$54.95
PRA-27088 Serial intf & 2K buffer \$99.95
PRA-27081 Apple card \$39.95
PRA-27082 Apple cable \$19.95
PRA-27086 IEEE 488 card \$59.95
PRA-27087 TRS-80 cable \$24.95
PRA-27097 GRAFTRAX-plus MX-80, FT \$59.95
PRA-27197 GRAFTRAX-plus MX-100 \$64.95
PRA-27090 MX-80, FT print head \$44.95
PRA-27190 MX-100 print head \$49.95
PRA-27083 MX-80 ribbon cart. \$13.95
PRA-27101 MX-100 ribbon only \$9.95

BETTER THAN EPSON! - Okidata

Microline 82A 80/132 column, 120 CPS, 9 x 9 dot matrix, friction feed, pin feed, adjustable tractor feed (optional), handles 4 part forms up to 9.5" wide, rear & bottom feed, paper tear bar, 100% duty cycle/200,000,000 character print head, bi-directional/logic seeking, both serial & parallel interfaces included, front panel switch & program control of 10 different form lengths, uses inexpensive spool type ribbons, double width & condensed characters, true lower case descenders & graphics
PRM-43082 Friction & pin feed \$499.95

Microline 83A 132/232 column, 120 CPS, forms up to 15" wide, removable tractor, plus all the features of the 82A.
PRM-43083 with FREE tractor \$744.95

Microline 84 132/232 column, Hi-speed 200 CPS, full dot graphics built in, plus all the features of the 83A.

PRM-43084 Centronics parallel \$1149.95
PRM-43085 Serial with 2K buffer \$1249.95
PRA-27081 Apple card \$39.95
PRA-27082 Apple cable \$19.95
PRA-27087 TRS-80 cable \$24.95
PRA-43081 2K hi speed serial card \$99.95
PRA-43082 Hi-res graphics ROMs 82A \$49.95
PRA-43083 Hi-graphics ROMs 83A \$49.95
PRA-43088 Tractor option for 82A \$49.95
PRA-43080 Extra ribbons pkg. of 2 \$9.95

8023 DOT MATRIX - NEC

100 CPS, proportional spacing, hi-resolution graphics, correspondence quality printing, bi-directional tractor & friction feed.

NEC-8023A 8023 parallel \$499.95
NEC-8023-01 8023 ribbon \$11.95

PRINTER PALS - F.M.J. Inc.

Desk top printer stand and continuous form paper holder.
PRA-99080 for MX-80, MX-80FT, Oki 82A, NEC \$29.95
PRA-99100 for MX-100, Oki 83A & 84 \$34.95
PRA-99700 for letter quality printers \$49.95

Jade Bus Probe

THE BUS PROBE - Jade

Inexpensive S-100 Diagnostic Analyzer

Double-high S-100 board which displays all 96 IEEE S-100 signals without the expense of an oscilloscope or a front panel

TSX-200B Bare board \$59.95
TSX-200K Kit \$119.95
TSX-200A A&T \$149.95

Dual Disk Sub-Systems

Disk Sub-Systems - Jade

Handsome metal cabinet with proportionally balanced air flow system, rugged dual drive power supply, power cable kit, power switch, line cord, fuse holder, cooling fan, never-mar rubber feet, all necessary hardware to mount 2-8" disk drives, power supply, and fan, does not include signal cable.

Dual 8" Sub-Assembly Cabinet

END-000420 Bare cabinet \$59.95
END-000421 Cabinet kit \$225.00
END-000431 A & T \$359.95

8" Sub-Systems - Single Sided, Double Density

END-000423 Kit w/2 FD100-8Ds \$975.00
END-000424 A & T w/2 FD100-8Ds \$1175.00
END-000433 Kit w/2 SA-801Rs \$999.95
END-000434 A & T w/2 SA-801Rs \$1195.00

8" Sub-Systems - Double Sided, Double Density

END-000426 Kit w/2 DT-8s \$1224.95
END-000427 A & T w/2 DT-8s \$1424.95
END-000436 Kit w/2 SA-851Rs \$1274.95
END-000437 A & T w/2 SA-851Rs \$1474.95

5 1/4" Disk Drives

Tandon TM100-1 single-sided double-density 48 TPI
MSM-551001 \$248.95 ea 2 for \$219.95 ea

Shugart SA400L single-sided double-density 40 track
MSM-104000 \$234.95 ea 2 for \$224.95 ea

Shugart SA455 half-size double-sided 48 TPI
MSM-104550 \$349.95 ea 2 for \$329.95 ea

Shugart SA465 half-size double-sided 96 TPI
MSM-104650 \$399.95 ea 2 for \$379.95 ea

Tandon TM100-2 double-sided double-density 48 TPI
MSM-551002 \$324.95 ea 2 for \$298.95 ea

Shugart SA450 double-sided double-density 35 track
MSM-104500 \$349.95 ea 2 for \$329.95 ea

Tandon TM100-3 single-sided double-density 96 TPI
MSM-551003 \$324.95 ea 2 for \$298.95 ea

Tandon TM100-4 double-sided double-density 96 TPI
MSM-551004 \$448.95 ea 2 for \$419.95 ea

MPI B-51 single-sided double-density 40 track
MSM-155100 \$234.95 ea 2 for \$224.95 ea

MPI B-52 double-sided double-density 40 track
MSM-155200 \$344.95 ea 2 for \$334.95 ea

MPI B-91 single-sided double-density 77 track
MSM-155300 \$369.95 ea 2 for \$359.95 ea

MPI B-92 double-sided double-density 77 track
MSM-155400 \$469.95 ea 2 for \$459.95 ea

5 1/4" Cabinets with Power Supply

END-000216 Single cab w/power supply \$69.95
END-000226 Dual cab w/power supply \$94.95

8" Disk Drives

Shugart SA810 half-size single-sided double-density
MSF-108100 \$424.95 ea 2 for \$394.95 ea

Shugart SA860 half-size double-sided double-density
MSF-108600 \$574.95 ea 2 for \$549.95 ea

Shugart SA801R single-sided double-density
MSF-10801R \$394.95 ea 2 for \$389.95 ea

Shugart SA851R double-sided double-density
MSF-10851R \$554.95 ea 2 for \$529.95 ea

Tandon TM848-1 single-sided double-den thin-line
MSF-558481 \$424.95 ea 2 for \$394.95 ea

Tandon TM848-2 double-sided double-den thin-line
MSF-558482 \$574.95 ea 2 for \$549.95 ea

Qume DT-8 double-sided double-density
MSF-750080 \$524.95 ea 2 for \$498.95 ea

Mitsubishi M2894-63 double-sided double-density
MSF-289463 \$549.95 ea 2 for \$524.95 ea

Siemens FDD 100-8 single-sided double-density
MSF-201120 \$384.95 ea 2 for \$349.95 ea

Prices may be slightly higher at our retail locations. Please contact the store in your area for exact pricing.

Hard Disk Drives

12 MEGABYTE SUB-SYSTEM - DayStar

12 Megabyte Winchester sub-system for most CP/M based microcomputers including Apple II, S-100, IBM PC, NEC, Xerox, TRS-80 II, Heath H-89, and others. Sub-system includes interface, controller, cabinet, power supply, CP/M software patch, & cables - ready to just plug in and run. A 1 Megabyte back-up drive is also available.

MSH-531010 S-100 sub-system \$2095.00
MSH-531020 Apple II sub-system \$2095.00
MSH-531030 NEC sub-system \$2095.00
MSH-531040 Xerox sub-system \$2095.00
MSH-531050 TRS-80 II sub-system \$2095.00
MSH-531060 IBM PC sub-system \$2095.00
MSH-531099 1 Megabyte back-up \$699.95

12 MEGABYTE WINCHESTER - Tandon

5 1/4" hard disk drive for hi-speed mass storage.

MSH-550603 Bare 5 1/4" drive \$1094.95

Letter Quality Printers

TP-1 LETTER QUALITY - SCM

10 CPS daisy wheel printer from Smith Corona.

PRD-45101 Centronics parallel \$699.95
PRD-45102 RS-232C serial \$749.95

LETTER QUALITY PRINTER - Jade

Uses standard daisy wheels and ribbon cartridges, 16 CPS bi-directional printing, semi-automatic paper loader (single sheet or fan fold), 10/12/15 pitch, up to 16" paper, built-in noise suppression cover.

PRD-11001 Centronics parallel \$959.95
PRD-11002 RS-232C serial model \$999.95

STARWRITER F-10 - C. Itoh

New 40 CPS daisy wheel printer with full 15" carriage, uses standard Diablo print wheels and ribbons, both parallel and serial interfaces included.

PRD-22010 Starwriter F-10 \$1495.95

80 CPS LETTER QUALITY - Fujitsu

High speed daisy wheel printer with both RS-232C serial & Centronics parallel interfaces, emulates NEC 5510, Diablo 630, Qume, and will interface to the IBM Personal Computer, features include Z-80 CPU, 16K buffer (48K optional), bi-directional printing, & baud rates up to 19.2K

PRD-86100 Fujitsu with 16K \$2895.00
PRD-86200 Fujitsu with 48K \$3195.00
PRA-86000 Adjustable tractor \$190.00

Software

PLANNER CALC - Target Software

Spread sheet (what if ?) program designed with the user in mind, user oriented (simple english) commands allow you to quickly master this powerful software package, supplied on disk for most CP/M based systems.

SFA-12251052M Apple II 5 1/4" CP/M \$49.95
SFC-12251050F SS SD 8" CP/M \$49.95
SFC-12251053F Xerox 8" CP/M \$49.95
SFC-12251053M Xerox 5 1/4" CP/M \$49.95
SFX-12251051M NEC 5 1/4" CP/M \$49.95

PAC MAN - Atari

Atari's best selling game for your 800 or 400 computer.

SFI-31254022E Pac Man cartridge \$37.95

Place Orders Toll Free

Continental U.S. Inside California
800-421-5500 800-262-1710

For Technical Inquires or Customer Service call:

213-973-7707

JADE

Computer Products

4901 W. Rosecrans, Hawthorne, Ca 90250

TERMS of SALE: Cash, checks, credit cards, or Purchase Orders from qualified firms and institutions.

Minimum Order \$15.00. California residents add 6% tax. Minimum shipping & handling charge \$3.00.

Pricing & availability subject to change

Computer Mfg. Dumps New Equipment

Forget that the company that bought these TRIPLE OUTPUT power supplies paid over \$300.00 each in truck load quantity. Disregard the advanced engineering and high efficiency switching outputs. Overlook the built in overvoltage protection and tight regulation. Don't even consider the little extras like thermal shutdown, status LED's and built in fuses. With all that out of mind ask yourself if a Triple Output Power Supply with good regulation and high current capability is worth our low price. If your answer is "yes" or "maybe", then go ahead and read the details. If your answer is "no", then you must not need a power supply!

This is the perfect supply for almost any computer application and gives you one supply that can drive logic, bipolar and MOS circuitry. Read the specs and think about owning one — but don't think too long. We have a limited quantity and this is a one time buy.

FEATURES:

- Output voltages:** +12V @ 7A
+ 5V @ 10A
(remote sense)
-12V @ 7A
- Regulation:** 2% Line & Load
- Ripple:** 200mv @ full load
- Fuses:** 3 (one primary, two DC sections)
- Input:** 117VAC
- Overvoltage Protection:** SCR type all 3 outputs
- Overcurrent:** Automatic foldback non-latching
- Thermal Protection:** Klixon® sensor shuts down all 3 voltages
- Output Section:** High efficiency Switching Darlingtons
- Packaging:** Open frame, common chassis unitized
- Weight:** 21 pounds
- Size:** 6 x 5-1/2 x 12

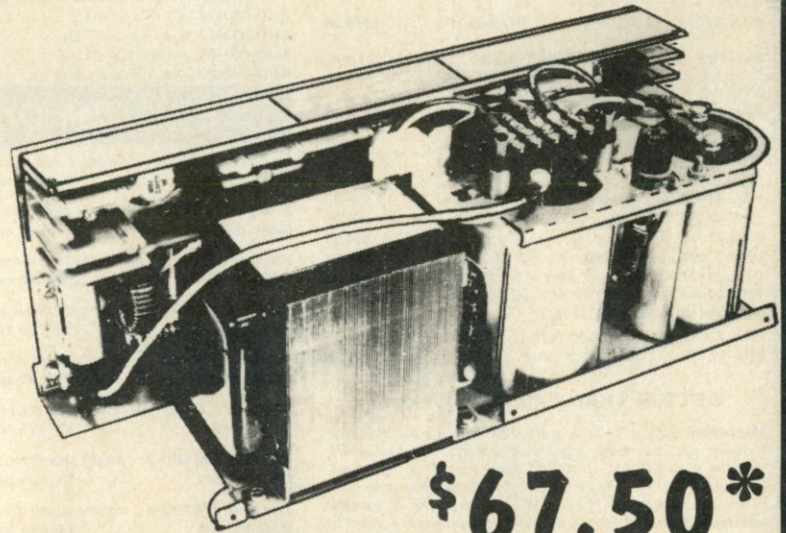

\$67.50*

***This Item Only
Outside Continental United States
call or write for specific freight charges.**

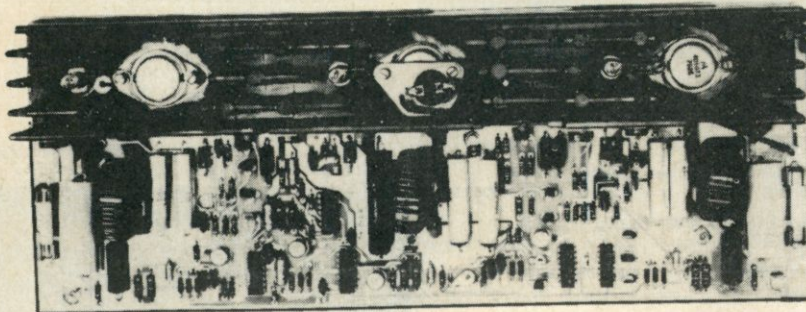

At no extra charge we include **complete schematics** and a detailed theory of operation. Also included are instructions for simple modifications that allow operation of the +12V section at any voltage from .5V to 25V.

By changing 4 parts the +12 section can be raised to +24 @ 5A with the same regulation and features. If you need power for your floppies (or hard disk) this Mod Kit will fill the bill.

**24 Volt Mod Kit w/instructions
\$5.00**

All units are guaranteed for 30 days after receipt. Repair parts and service available.

MODEMS

General DataComm direct-connect, auto-answer/originate. FCC Type Approved. Bell 103 standard tones (300 baud). Like new with 90-day warranty. Full documentation provided (schematics \$2.50 extra). Normal/loopback self-checks data in/out on both digital and analog basis. Compatible with any terminal or computer with RS-232C serial I/O port. **LIMITED SUPPLY! \$127.50**

TERMS: Add \$1.50 postage, we pay balance. Orders over \$50.00 add 85¢ for insurance. No C.O.D. Texas Res. add 5% Tax. 90 Day Money Back Guarantee on all items. All items subject to prior sale. Prices subject to change without notice. Foreign order - U.S. funds only. We cannot ship to Mexico. Countries other than Canada, add \$3.50 shipping and handling.

COMPUTERS ATARI® 800™ COMPUTER SYSTEM



400 w/16K \$350.00
800 w/16K \$699.00
★800 Computer w/48K
★BEST BUY \$825.00

ATARI PERIPHERALS:

Printer 825-6500 • Asteroids
Disk Dr. 810-4850 • Missile Com. → 32.50
Record 410-8200 • Sup Brk Out
Paddle (pr.) > 16.95 • Assem. Edit- 49.00
Joystick (pr.) > 16.95 • Star Raiders- 45.00
32k RAM- 179.95 • Basketball- 28.00
Basic Cart- 49.00 • Chess- 32.00

Other "ATARI" Hard/Software Avail. !!

MONITORS

ZENITH # ZVM-121

12in. 15MHz./GREEN Phos.
\$113.00

J.C.S.#KG-12

12in. 19MHz./GREEN Phos.
Non-Glare Screen \$134.50

BMC#BM-12A

12in. 15MHz./GREEN Phos.
\$95.00

AMDEK#CM-13 (COLOR I)

13in./COLOR!!
\$375.00

Diskette Storage BOX

➔ HARD PLASTIC ➔

5 1/4 inch → \$2.95ea. (SRW)

8 inch → \$4.75ea. ★ ★ ★
QTY. PRICE AVAIL.

Bare Bones **APPLE II**

w/o Keyboard = 48K RAM =
\$450.
w/o Pwr. Supply

Microswitch: Power Supply: APPLE
Keyboard/Pad: 5amp.: Reference Manl.
\$95.00 : \$124.00 : \$18.00

CONCORD COMPUTER PRODUCTS

1971 SO. STATE COLLEGE
ANAHEIM, CALIF. 92806

(714) 937-0637

VISA CHECK - M/O NO COD

\$10. MIN ORDER CA RES ADD 6

\$10 49 \$2.00 \$250 499 \$9.00
50 99 4.00 500 999 11.00
100 240 8.00 1000 UP CALL

FREIGHT

Diskette SALE!!

"Wabash"

5 1/4 8inch
SS/SD \$22.00 \$25.00

SS/DD 27.40 30.40

DS/SD 0 34.90

DS/DD 32.40 37.40

[QTY. PRICE AVAIL.]

Authorized Wabash Dist.

* SPECIALS *

3inch Mini FAN → \$8.95

2111 → \$2.45

8155 → \$11.50

ER2501 → \$4.95

AY5 1013A → \$2.95

8202 → \$29.95

6522 → \$5.25

2716(+5V) → \$4.50

2732 → \$8.95

50pin Connectors → \$3.25

EPROM Eraser → \$69.95

APPLE Joystick → \$42.95

REAL-TIME CLOCK CALENDAR (MSM 5832)

Description: Mono. Metal Gate CMOS I.C.

Features

Time, Month, Date, Year, &
Day of Week

• Bus Oriented

• 4 Bit Data Bus

• 4 Bit Address

• R/W Hold Selec. +

\$7.45

W/SPEC'S

• Inter. Signal

XTAL

• 32.768Khz. xtal Control.

\$2.85

• 5v Pow. Sup.

• Low Power Dissipation

NO P.O. BOX
SHIPMENTS

8255 → \$5.95
8748-8 → \$31.00
3341PC → \$2.00
MM5060 → 35¢
MC6800 → \$7.75
MC6802 → \$14.95
MC6850 → \$4.50
MC6821 → \$4.95

8 Pos. DIP
SWITCH

\$1.35ea.

10pcs/\$10.00

CARDS

Z80 \$295.00

16K RAM \$105.00

VIDEX
VIDEOTERM
80 column \$295.00

KEYBOARD
ENHANCER \$120.00

CALIF. COMP SYS

APPLE
CLOCK \$124.00

TERMINAL



IQ
120



\$689.00

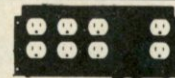

NO Surges or Interference!!
THE MPD 117
turns an ordinary
outlet into a con-
trolled power source

\$79.50

"GLOBAL"
LPK-1:

Logic Probe
Kit - complete
nothing extra
to buy. Min.
pulse width
300nsec.

\$18.95

COMPONENTS

7400	18	7454	19
7402	18	7470	29
7404	18	7472	29
7406	21	7474	30
7408	21	7476	30
7410	18	7478	30
7411	18	7480	30
7412	26	7481	1.90
7413	32	7489	3.90
7414	24	7490	3.90
7416	24	7492	4.25
7417	24	7494	4.25
7420	18	7495	6.00
7421	30	74100	9.00
7425	25	74107	2.50
7427	25	74112	4.00
7430	18	74125	4.00
7435	25	74144	2.50
7440	18	74145	1.00
7442	45	74148	1.00
7443	45	74154	1.00
7444	60	74160	8.00
7449	60	74161	8.00
7450	60	74162	8.00
7451	18	74174	9.00
7453	19	74181	1.90
		74393	1.00

LS SERIES

74LS00	24	74LS125	90
74LS02	24	74LS126	85
74LS04	24	74LS130	85
74LS08	24	74LS132	85
74LS16	24	74LS138	85
74LS20	24	74LS139	85
74LS24	24	74LS145	1.10
74LS27	24	74LS146	1.10
74LS30	24	74LS147	1.10
74LS32	24	74LS148	1.10
74LS33	24	74LS149	1.10
74LS37	24	74LS150	1.10
74LS39	24	74LS151	1.10
74LS42	24	74LS152	1.10
74LS44	24	74LS153	1.10
74LS47	24	74LS154	1.10
74LS48	24	74LS155	1.10
74LS49	24	74LS156	1.10
74LS50	24	74LS157	1.10
74LS51	24	74LS158	1.10
74LS52	24	74LS159	1.10
74LS53	24	74LS160	1.10
74LS54	24	74LS161	1.10
74LS55	24	74LS162	1.10
74LS56	24	74LS163	1.10
74LS57	24	74LS164	1.10

74S SERIES

74S00	35	74S86	1.10
74S02	38	74S112	1.45
74S03	38	74S132	1.10
74S04	45	74S138	95
74S05	65	74S140	1.25
74S08	40	74S158	1.25
74S10	55	74S174	95
74S15	55	74S175	95
74S20	55	74S181	4.00
74S22	75	74S182	2.75
74S30	35	74S188	3.50
74S37	1.25	74S240	3.50
74S51	80	74S244	3.50
74S65	95	74S471	9.50
74S74	55	74S472	15.00
74S85	2.00		

EPROMS

1702	4	25	8/3	95**
2708	2	95	8/2	85**
2716(15V)	5	00	8/4	50**
2732(15V)	8	95	8/8	00**
2732(15V)	10	50	8/8	25**
2752(15V)	11	50	8/10	25**

DYNAMIC RAMS

4027	2	00	8/1	75**	
4116	200	ns	1	8/13	00**
4164	200	ns	9	50	

STATIC RAMS

2111	2	85	8/2	50**		
2112	3	85	8/2	50**		
2114	3	00	4/4	00**		
2141	200	ns	11	20	4/2	00**
HM6116	200	ns	11	20	4/10	50**

MISC.

8126	1.20	CPU S	
8128	1.20	Z80	8.50
8038	2.75	Z80A	6.00
8086A	3.75	Z80A PNO	6.00
8155	10.50	6502	6.00
8255	4.50	6502A	12.00
MC1330	1.85	8085A	8.50
MC1350	1.15	MC6800	7.75
MC1358	1.50		
MC1458	55		
LM380	1.10		
LM385	1.40		
LM385	95		
LM741	25	VOLTAGE	
LM1310	2.90	REGULATORS	
LM1800	2.95	7805	
LM1889	1.45	7806	
1488	95	7808	
1489	95	7812	
8212	1.95	7818	85
8216	1.90	7908	
1103A	95	7912	
		7918	

'1982'
IC MASTER
2 Vols.

\$59.95

4116 16K DYNAMIC 250NS **8/\$11⁹⁵** SET

2114 1KX4 STATIC LOW POWER 200NS **8/\$15⁹⁵** SET

ALL MERCHANDISE 100% GUARANTEED!

CALL US FOR VOLUME QUOTES

STATIC RAMS

Part No.	Capacity	Access Time	Each	100 pcs
2101	256 x 4	(450ns)	1.95	1.85
5101	256 x 4	(cmos) (450ns)	4.95	3.95
2102-1	1024 x 1	(450ns)	.89	.85
2102L-2	1024 x 1	(LP) (250ns)	1.69	1.55
2102L-4	1024 x 1	(LP) (450ns)	1.29	1.15
2111	256 x 4	(450ns)	2.99	2.49
2112	256 x 4	(450ns)	2.99	2.79
2114	1024 x 4	(450ns)	8/16.95	1.95
2114L-2	1024 x 4	(LP) (200ns)	8/15.95	1.90
2114L-3	1024 x 4	(LP) (300ns)	8/18.95	2.25
2114L-4	1024 x 4	(LP) (450ns)	8/17.95	2.10
2147	4096 x 1	(55ns)	9.95	call
TMS4044-4	4096 x 1	(450ns)	3.49	3.25
TMS4044-3	4096 x 1	(300ns)	3.99	3.75
TMS4044-2	4096 x 1	(200ns)	4.49	4.25
MK4118	1024 x 8	(250ns)	9.95	call
TMM2016-200	2048 x 8	(200ns)	call	call
TMM2016-150	2048 x 8	(150ns)	call	call
HM6116-4	2048 x 8	(cmos) (200ns)	call	call
HM6116-3	2048 x 8	(cmos) (150ns)	call	call
HM6116-2	2048 x 8	(cmos) (120ns)	call	call
HM6116LP-4	2048 x 8	(LP)(cmos)(200ns)	call	call
HM6116LP-3	2048 x 8	(LP)(cmos)(150ns)	call	call
HM6116LP-2	2048 x 8	(LP)(cmos)(120ns)	call	call
Z-6132	4096 x 8	(Qstat)(300ns)	34.95	call

LP - Low Power Qstat = Quasi-Static

DYNAMIC RAMS

Part No.	Capacity	Access Time	Each	100 pcs
TMS4027	4096 x 1	(250ns)	2.50	2.00
MK4108	8192 x 1	(200ns)	1.95	call
MM5298	8192 x 1	(250ns)	1.85	call
4116-120	16384 x 1	(120ns)	8/29.95	call
4116-150	16384 x 1	(150ns)	8/18.95	1.95
4116-200	16384 x 1	(200ns)	8/13.95	call
4116-250	16384 x 1	(250ns)	8/11.95	call
4116-300	16384 x 1	(300ns)	8/13.80	call
2118	16384 x 1	(5v) (150ns)	4.95	call
MK4816	2048 x 8	(5v) (300ns)	24.95	call
4164-200	65536 x 1	(5v) (200ns)	call	call
4164-150	65536 x 1	(5v) (150ns)	call	call

EPROMS

Part No.	Capacity	Access Time	Each	8 pcs
1702	256 x 8	(1us)	4.95	4.50
2708	1024 x 8	(450ns)	3.75	3.50
2758	1024 x 8	(5v) (450ns)	9.95	8.95
TMS2516	2048 x 8	(5v) (450ns)	6.95	5.95
2716	2048 x 8	(5v) (450ns)	4.95	3.95
2716-1	2048 x 8	(5v) (350ns)	9.00	8.50
TMS2716	2048 x 8	(450ns)	9.95	8.95
TMS2532	4096 x 8	(5v) (450ns)	9.95	7.95
2732	4096 x 8	(5v) (450ns)	9.95	7.95
2732A-2	4096 x 8	(5v) (200ns)	call	call
2764	8192 x 8	(5v) (450ns)	call	call
TMS2564	8192 x 8	(5v) (450ns)	call	call
MC68764	8192 x 8	(5v) (450ns) (24pin)	call	call

5v - Single 5 Volt Supply

EPROM ERASERS

Part No.	Timer	Capacity Chip	Intensity (uW/Cm ²)	Price
PE-14		6	5,200	83.00
PE-14T	X	6	5,200	119.00
PE-24T	X	9	6,700	175.00
PL-265T	X	20	6,700	255.00
PR-125T	X	16	15,000	349.00
PR-320	X	32	15,000	595.00

HOURS:
M-F, 9-5; Sat. 11-3
**VISIT OUR
RETAIL STORE**



**Z-80
2.5 Mhz**

Z80-CPU	3.95
Z80-CTC	5.95
Z80-DART	15.25
Z80-DMA	17.50
Z80-PIO	5.75
Z80-SIO/0	18.50
Z80-SIO/1	18.50
Z80-SIO/2	18.50
Z80-SIO/9	16.95

4.0 Mhz

Z80A-CPU	6.00
Z80A-CTC	8.65
Z80A-DART	18.75
Z80A-DMA	27.50
Z80A-PIO	6.00
Z80A-SIO/0	22.50
Z80A-SIO/1	22.50
Z80A-SIO/2	22.50
Z80A-SIO/9	19.95

6.0 Mhz

Z80B-CPU	17.95
Z80B-CTC	15.50
Z80B-PIO	15.50

ZILOG

Z6132	34.95
Z8671	39.95

8200

8202	34.95
8205	3.50
8212	1.85
8214	3.85
8216	1.80
8224	2.50
8226	1.80
8228	4.90
8237	19.95
8238	4.95
8243	4.45
8250	14.95
8251	4.75
8253	9.25
8253-5	9.85
8255	4.75
8255-5	5.25
8257	8.50
8257-5	8.95
8259	6.90
8259-5	7.50
8272	39.95
8275	29.95
8279	9.50
8279-5	10.00
8282	6.65
8283	6.65
8284	5.70
8286	6.65
8287	6.50
8288	25.00
8289	49.95

8000

8035	7.25
8039	7.95
INS-8060	17.95
INS-8073	29.95
8080	3.95
8085	7.95
8085A-2	11.95
8086	29.95
8088	39.95
8089	89.95
8155	7.95
8156	8.95
8185	29.95
8185-2	39.95
8741	39.95
8748	29.95
8755	32.00

6800

68000	99.9
6800	4.9
6802	10.9
6808	13.9
6809E	19.9
6809	12.9
6810	2.9
6820	4.9
6821	4.9
6828	14.9
6840	12.9
6843	34.9
6844	25.9
6845	16.9
6847	12.2
6850	3.4
6852	5.7
6860	10.9
6862	11.9
6875	6.9
6880	2.9
6883	24.9
68047	24.9
68488	19.9
6800 = 1MHZ	
68B00	10.9
68B02	22.2
68B09E	29.9
68B09	29.9
68B10	7.9
68B21	12.9
68B45	35.9
68B50	12.9
68B00 = 2 MHZ	

DISC CONTROLLERS

1771	20.95
1791	29.95
1793	38.95
1795	54.95
1797	54.95
6843	34.95
8272	39.95
UPD765	39.95
1691	18.95
2143	18.95

INTERFACE

8T26	1.69
8T28	2.49
8T95	.99
8T96	.99
8T97	.99
8T98	.99
DM8131	2.95
DP8304	2.29

MISC.

3341	4.95
76477	3.95
AY3-8910	12.95
MC3340	1.49
95H90	7.99
11C90	13.95
8202A	34.95
3242	7.95
MC3480	9.00
8038	3.95
2513-001 UP	9.95
2513-002 LOW	9.95
3205	3.50

BIT-RATE GENERATORS

14411	11.95
BR1941	11.95
4702	12.95
COM5016	16.95
MM5307	10.95

UARTS

AY3-1014	6.95
AY5-1013	3.95
PT1472	9.95
TR1602	3.95
2350	9.95
TMS6011	5.95
IM6402	7.95
IM6403	8.95
INS8250	14.95

KEYBOARD CHIPS

AY5-2376	11.95
AY5-3600	11.95
74C922	5.25
74C923	5.50

CLOCK CIRCUITS

MM5314	4.95
MM5369	3.95
MM5375	4.95
MM58167	8.95
MM58174	11.95
MSM5832	6.95

**6500
1 MHZ**

6502	5.9
6504	6.9
6505	8.9
6507	9.9
6520	4.3
6522	8.7
6532	11.2
6545	22.5
6551	11.8

2 MHZ

6502A	9.9
6522A	11.7
6532A	12.4
6545A	28.5
6551A	12.9

3 MHZ

6502B	14.9
-------	------

CRYSTALS

32.768 khz	1.95
1.0 mhz	4.95
1.8432	4.95
2.0	3.95
2.097152	3.95
2.4576	3.95
3.2768	3.95
3.579535	3.95
4.0	3.95
5.0	3.95
5.0688	3.95
5.185	3.95
5.7143	3.95
6.0	3.95
6.144	3.95
6.5536	3.95
8.0	3.95
10.0	3.95
14.31818	3.95
15.0	3.95
16.0	3.95
18.0	3.95
18.432	3.95
20.0	3.95
22.1184	3.95
32.0	3.95

**ORDER TOLL FREE
800-538-5000
800-662-6279
(CALIFORNIA RESIDENTS)**

IF YOU CAN FIND A PRICE LOWER ELSEWHERE, LET US KNOW AND WE'LL MEET OR BEAT THEIR PRICE!
(SEE TERMS BELOW)

- * Computer managed inventory—virtually no back orders!
- * Very competitive prices!
- * Friendly staff!
- * Fast service — most orders shipped within 24 hours!

MONTHLY SPECIALS

CPU SALE

8 BIT

Z-80 CPU 2MHZ	\$3.95 (10/ 3.75 EA)
6502 1 MHZ	\$5.95 (10/ 5.75 EA)
6809 INT. CLOCK	\$12.95 (10/11.25 EA)

16 BIT

8086	\$29.95
68000 8MHZ	\$99.95

SALE ENDS SEPTEMBER 30, 1982

PLEASE STATE

"SEPTEMBER SPECIALS" WHEN ORDERING

JDR MICRODEVICES, INC.

1224 S. Bascom Avenue
San Jose, CA 95128

800-538-5000 • 800-662-6279 (CA)
(408) 995-5430 • Telex 171-110

PLEASE USE YOUR CUSTOMER NUMBER WHEN ORDERING

TERMS: For shipping include \$2 for UPS Ground or \$3 for UPS Blue Label Air. Items over 5 pounds require additional shipping charges. Foreign orders, include sufficient amount for shipping. There is a \$10 minimum order. Bay Area and Los Angeles Counties add 6% Sales Tax. Other California residents add 6% Sales Tax. We reserve the right to substitute manufacturer. Not responsible for typographical errors. Prices are subject to change without notice. We will match or beat any competitor's price provided it is not below our cost.

DIGITAL RESEARCH COMPUTERS

(214) 271-3538

32K S-100 EPROM CARD NEW!

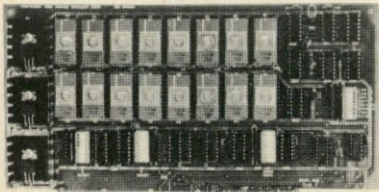

\$79.95
KIT

USES 2716's
Blank PC Board - \$34
ASSEMBLED & TESTED
ADD \$30

SPECIAL: 2716 EPROM's (450 NS) Are \$9.95 Ea. With Above Kit.

KIT FEATURES:

1. Uses +5V only 2716 (2Kx8) EPROM's.
2. Allows up to 32K of software on line!
3. IEEE S-100 Compatible.
4. Addressable as two independent 16K blocks.
5. Cromemco extended or Northstar bank select.
6. On board wait state circuitry if needed.
7. Any or all EPROM locations can be disabled.
8. Double sided PC board, solder-masked, silk-screened.
9. Gold plated contact fingers
10. Unselected EPROM's automatically powered down for low power.
11. Fully buffered and bypassed.
12. Easy and quick to assemble.

64K S100 STATIC RAM

\$349⁰⁰
KIT

NEW!

LOW POWER!
RAM OR EPROM!
BLANK PC BOARD
WITH DOCUMENTATION
\$55

SUPPORT ICs + CAPS
\$17.50
FULL SOCKET SET
\$14.50

FULLY SUPPORTS THE
NEW IEEE 696 S100
STANDARD
(AS PROPOSED)

FOR 56K KIT \$299
ASSEMBLED AND
TESTED ADD \$40

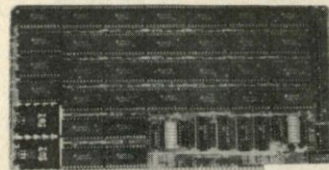

FEATURES:

- * Uses new 2K x 8 (TMM 2016 or HM 6116) RAMs.
- * Fully supports IEEE 696 24 BIT Extended Addressing.
- * 64K draws only approximately 500 MA.
- * 200 NS RAMs are standard. (TOSHIBA makes TMM 2016s as fast as 100 NS. FOR YOUR HIGH SPEED APPLICATIONS.)
- * SUPPORTS PHANTOM (BOTH LOWER 32K AND ENTIRE BOARD).
- * 2716 EPROMs may be installed in any of top 48K.
- * Any of the top 8K (E000 H AND ABOVE) may be disabled to provide windows to eliminate any possible conflicts with your system monitor, disk controller, etc.
- * Perfect for small systems since BOTH RAM and EPROM may co-exist on the same board.
- * BOARD may be partially populated as 56K.

16K STATIC RAM KIT-S 100 BUSS

PRICE CUT!
\$149⁹⁵
KIT

FOR 4MHZ
ADD \$10

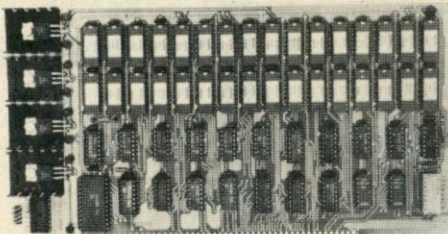

KIT FEATURES:

1. Addressable as four separate 4K Blocks.
2. ON BOARD BANK SELECT circuitry (Cromemco Standard). Allows up to 512K on line!
3. Uses 2114 (450NS) 4K Static Rams.
4. ON BOARD SELECTABLE WAIT STATES.
5. Double sided PC Board, with solder mask and silk screened layout. Gold plated contact fingers
6. All address and data lines fully buffered
7. Kit includes ALL parts and sockets.
8. PHANTOM is jumpered to PIN 67.
9. LOW POWER: under 1.5 amps TYPICAL from the +8 Volt Buss
10. Blank PC Board can be populated as any multiple of 4K.

BLANK PC BOARD W/DATA-\$33
LOW PROFILE SOCKET SET-\$12
SUPPORT IC'S & CAPS-\$19.95
ASSEMBLED & TESTED-ADD \$35

OUR #1 SELLING
RAM BOARD!

64K SS-50 STATIC RAM

\$259⁰⁰
(48K KIT)

NEW!

LOW POWER!
RAM OR EPROM!
BLANK PC BOARD
WITH
DOCUMENTATION
\$52

SUPPORT ICs + CAPS
\$18.00
FULL SOCKET SET
\$15.00

56K Kit \$309
64K Kit \$359
ASSEMBLED AND
TESTED ADD \$40

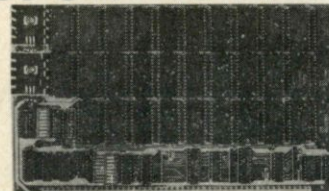

FEATURES:

- * Uses new 2K x 8 (TMM 2016 or HM 6116) RAMs.
- * Fully supports Extended Addressing.
- * 64K draws only approximately 500 MA.
- * 200 NS RAMs are standard. (TOSHIBA makes TMM 2016s as fast as 100 NS. FOR YOUR HIGH SPEED APPLICATIONS.)
- * Board is configured as 3-16K blocks and 8-2K blocks (within any 64K block) for maximum flexibility.
- * 2716 EPROMs may be installed anywhere on Board.
- * Top 16K may be disabled in 2K blocks to avoid any I/O conflicts.
- * One Board supports both RAM and EPROM.
- * RAM supports 2MHZ operation at no extra charge!
- * Board may be partially populated in 16K increments.

STEREO! S-100 SOUND COMPUTER BOARD

NEW!

At last, an S-100 Board that unleashes the full power of two unbelievable General Instruments AY3-8910 NMOS computer sound IC's. Allows you under total computer control to generate an infinite number of special sound effects for games or any other program. Sounds can be called in BASIC, ASSEMBLY LANGUAGE, etc.

KIT FEATURES:

- * TWO GI SOUND COMPUTER IC'S.
 - * FOUR PARALLEL I/O PORTS ON BOARD.
 - * USES ON BOARD AUDIO AMPS OR YOUR STEREO.
 - * ON BOARD PROTO TYPING AREA.
 - * ALL SOCKETS, PARTS AND HARDWARE ARE INCLUDED.
 - * PC BOARD IS SOLDERMASKED, SILK SCREENED, WITH GOLD CONTACTS.
 - * EASY, QUICK, AND FUN TO BUILD, WITH FULL INSTRUCTIONS.
 - * USES PROGRAMMED I/O FOR MAXIMUM SYSTEM FLEXIBILITY.
- Both Basic and Assembly Language Programming examples are included.

SOFTWARE:

SCL™ is now available! Our Sound Command Language makes writing Sound Effects programs a SNAP! SCL™ also includes routines for Register-Examine-Modify, Memory-Examine-Modify, and Play-Memory. SCL™ is available on CP/M™ compatible diskette or 2708 or 2716. Diskette - \$24.95 2708 - \$19.95 2716 - \$29.95. Diskette includes the source. EPROM'S are ORG at E000H. (Diskette is 8 Inch Soft Sector)

COMPLETE KIT!

\$84⁹⁵

(WITH DATA MANUAL)

BLANK PC
BOARD W/DATA
\$31

SPECIAL PURCHASE!

UART SALE!

TR1602B - SAME AS TMS6011,
AY5-1013, ETC. 40 PIN DIP

TR1602B

\$2⁹⁵ EACH

4 For \$10⁰⁰

CRT CONTROLLER CHIP

SMC #CRT 5037. PROGRAMMABLE FOR 80 x 24, ETC. VERY RARE
SURPLUS FIND. WITH PIN OUT. \$12.95 EACH.

NEW! G.I. COMPUTER SOUND CHIP

AY3-8910. As featured in July, 1979 BYTE! A fantastically powerful Sound & Music Generator. Perfect for use with any 8 Bit Microprocessor. Contains: 3 Tone Channels, Noise Generator, 3 Channels of Amplitude Control, 16 bit Envelope Period Control, 2-8 Bit Parallel I/O, 3 D to A Converters, plus much more! All in one 40 Pin DIP. Super easy interface to the S-100 or other busses. **\$11.95** PRICE CUT!
SPECIAL OFFER: **\$14.95** each Add \$3 for 60 page Data Manual.

Digital Research Computers

(OF TEXAS)
P.O. BOX 401565 • GARLAND, TEXAS 75040 • (214) 271-3538

TERMS: Add \$2.00 postage. We pay balance. Orders under \$15 add 75¢ handling. No C.O.D. We accept Visa and MasterCard. Tex. Res. add 5% Tax. Foreign orders (except Canada) add 20% P & H. Orders over \$50, add 85¢ for insurance.

ALL SALES ARE MADE SUBJECT TO THE TERMS OF OUR 90 DAY LIMITED WARRANTY. A COPY OF THIS WARRANTY IS AVAILABLE FREE, ON REQUEST.

2716 16K EPROMS **8/\$3⁹⁵** EACH

2732 32K EPROMS **8/\$7⁹⁵** EACH

ALL MERCHANDISE 100% GUARANTEED!

CALL US FOR VOLUME QUOTES

74LS00

74LS00	.25	74LS85	1.15	74LS168	1.75	74LS295	1.05
74LS01	.25	74LS86	.40	74LS169	1.75	74LS298	1.20
74LS02	.25	74LS90	.65	74LS170	1.75	74LS324	1.75
74LS03	.25	74LS91	.89	74LS173	.80	74LS352	1.55
74LS04	.25	74LS92	.70	74LS174	.95	74LS353	1.55
74LS05	.25	74LS93	.65	74LS175	.95	74LS363	1.35
74LS08	.35	74LS95	.85	74LS181	2.15	74LS364	1.95
74LS09	.35	74LS96	.95	74LS189	9.95	74LS365	.95
74LS10	.25	74LS107	.40	74LS190	1.00	74LS366	.95
74LS11	.35	74LS109	.40	74LS191	1.00	74LS367	.70
74LS12	.35	74LS112	.45	74LS192	.85	74LS368	.70
74LS13	.45	74LS113	.45	74LS193	.95	74LS373	1.75
74LS14	1.00	74LS114	.50	74LS194	1.00	74LS374	1.75
74LS15	.35	74LS122	.45	74LS195	.95	74LS377	1.45
74LS20	.25	74LS123	.95	74LS196	.85	74LS378	1.18
74LS21	.35	74LS124	2.99	74LS197	.85	74LS379	1.35
74LS22	.25	74LS125	.95	74LS221	1.20	74LS385	1.90
74LS26	.35	74LS126	.85	74LS240	1.29	74LS386	.65
74LS27	.35	74LS132	.75	74LS241	1.29	74LS390	1.90
74LS28	.35	74LS136	.55	74LS242	1.85	74LS393	1.90
74LS30	.25	74LS137	.99	74LS243	1.85	74LS395	1.65
74LS32	.35	74LS138	.75	74LS244	1.29	74LS399	1.70
74LS33	.55	74LS139	.75	74LS245	1.90	74LS424	2.95
74LS37	.55	74LS145	1.20	74LS247	.75	74LS447	.37
74LS38	.35	74LS147	2.49	74LS248	1.25	74LS490	1.95
74LS40	.35	74LS148	1.35	74LS249	.99	74LS624	3.99
74LS42	.55	74LS151	.75	74LS251	1.30	74LS668	1.69
74LS47	.75	74LS153	.75	74LS253	.85	74LS669	1.89
74LS48	.75	74LS154	2.35	74LS257	.85	74LS670	2.20
74LS49	.75	74LS155	1.15	74LS258	.85	74LS674	9.65
74LS51	.25	74LS156	.95	74LS259	2.85	74LS682	3.20
74LS54	.35	74LS157	.75	74LS260	.65	74LS683	2.30
74LS55	.35	74LS158	.75	74LS266	.55	74LS684	2.40
74LS63	1.25	74LS160	.90	74LS273	1.65	74LS685	2.40
74LS73	.40	74LS161	.95	74LS275	3.35	74LS688	2.40
74LS74	.45	74LS162	.95	74LS279	.55	74LS689	2.40
74LS75	.50	74LS163	.95	74LS280	1.98	74LS783	24.95
74LS76	.40	74LS164	.95	74LS283	1.00	81LS95	1.69
74LS78	.50	74LS165	.95	74LS290	1.25	81LS96	1.69
74LS83	.75	74LS166	2.40	74LS293	1.85	81LS97	1.69
						81LS98	1.69

74S00

74S00	.44	74S85	2.39	74S169	5.44	74S274	19.95
74S02	.48	74S86	1.44	74S174	1.09	74S275	19.95
74S03	.48	74S112	1.59	74S175	1.09	74S280	2.90
74S04	.79	74S113	1.98	74S181	4.47	74S287	4.75
74S05	.79	74S114	1.50	74S182	2.95	74S288	4.45
74S08	.48	74S124	2.77	74S188	3.95	74S289	6.98
74S09	.98	74S132	1.24	74S189	14.95	74S301	6.95
74S10	.69	74S133	.98	74S194	2.95	74S373	3.45
74S11	.88	74S134	.69	74S195	1.89	74S374	3.45
74S15	.70	74S135	1.48	74S196	4.90	74S381	7.95
74S20	.68	74S138	1.08	74S197	4.25	74S387	5.75
74S22	.98	74S139	1.25	74S201	14.95	74S412	2.98
74S30	.48	74S140	1.45	74S225	8.95	74S471	9.95
74S32	.98	74S151	1.19	74S240	3.98	74S472	16.85
74S37	1.87	74S153	1.19	74S241	3.75	74S474	17.85
74S38	1.68	74S157	1.19	74S244	3.98	74S482	15.60
74S40	.44	74S158	1.45	74S251	1.90	74S570	7.80
74S51	.78	74S161	2.85	74S253	7.45	74S571	7.80
74S64	.79	74S162	3.70	74S257	1.39		
74S65	1.25	74S163	3.75	74S258	1.49		
74S74	.69	74S168	4.65	74S260	1.83		

IC SOCKETS

1-99		100	
8 pin ST	.13	.11	
14 pin ST	.15	.12	
16 pin ST	.17	.13	
18 pin ST	.20	.18	
20 pin ST	.29	.27	
22 pin ST	.30	.27	
24 pin ST	.30	.27	
28 pin ST	.40	.32	
40 pin ST	.49	.39	
ST - SOLDERTAIL			
8 pin WW	.59	.49	
14 pin WW	.69	.52	
16 pin WW	.69	.58	
18 pin WW	.99	.90	
20 pin WW	1.09	.98	
22 pin WW	1.39	1.28	
24 pin WW	1.49	1.35	
28 pin WW	1.69	1.49	
40 pin WW	1.99	1.80	
WW - WIREWRAP			
16 pin ZIF	6.75	call	
24 pin ZIF	9.95	call	
ZIF - TEXTTOOL (Zero Insertion Force)			

CONNECTORS

RS232 MALE	3.25
RS232 FEMALE	3.75
RS232 FEMALE	3.75
RIGHT ANGLE	5.25
RS232 HOOD	1.25
S-100 ST	3.95
S-100 WW	4.95

DIP SWITCHES

4 POSITION	.85
5 POSITION	.90
6 POSITION	.90
7 POSITION	.95
8 POSITION	.95

9000 SERIES

9316	1.00
9334	2.50
9368	3.95
9401	9.95
9601	.75
9602	1.50
96S02	1.95

DATA ACQUISITION

ADC0800	15.55
ADC0804	4.95
ADC0809	5.25
ADC0817	10.95
DAC0800	4.95
DAC0808	4.95
DAC1020	8.25
DAC1022	8.25
MC1408L8	4.95

INTERSIL

ICL7103	9.50
ICL7106	9.95
ICL7107	12.95
ICL8038	3.95
ICM7107A	5.59
ICM7208	15.95

7400

7400	.19	74136	.50
7401	.19	74141	.65
7402	.19	74142	2.95
7403	.19	74143	2.95
7404	.19	74145	.60
7405	.25	74147	1.75
7406	.29	74148	1.20
7407	.29	74150	1.35
7408	.24	74151	.65
7409	.19	74152	.65
7410	.19	74153	.55
7411	.25	74154	1.40
7412	.30	74155	.75
7413	.35	74156	.65
7414	.55	74157	.55
7416	.25	74159	1.65
7417	.25	74160	.85
7420	.19	74161	.70
7421	.35	74162	.85
7422	.29	74163	.85
7423	.29	74164	.85
7425	.29	74165	.85
7426	.29	74166	1.00
7427	.29	74167	2.95
7428	.45	74170	1.65
7430	.19	74172	5.95
7432	.29	74173	.75
7433	.45	74174	.89
7437	.29	74175	.89
7438	.29	74176	.89
7440	.19	74177	.75
7442	.49	74178	1.15
7443	.65	74179	1.75
7444	.69	74180	.75
7445	.69	74181	2.25
7446	.59	74182	.75
7447	.69	74184	2.00
7448	.69	74185	2.00
7450	.19	74132	.45
7451	.23	74190	1.15
7453	.23	74191	1.15
7454	.23	74192	.79
7460	.23	74193	.79
7470	.35	74194	.85
7472	.29	74195	.85
7473	.34	74196	.79
7474	.35	74197	.75
7475	.49	74198	1.35
7476	.35	74199	1.35
7480	.59	74221	1.35
7481	1.10	74246	1.35
7482	.95	74247	1.25
7483	.50	74248	1.85
7485	.65	74249	1.95
7486	.35	74251	.75
7489	4.95	74259	2.25
7490	.35	74265	1.35
7491	.40	74273	1.95
7492	.50	74276	1.25
7493	.49	74279	.75
7494	.65	74283	2.00
7495	.55	74284	3.75
7496	.70	74285	3.75
7497	2.75	74290	.95
74100	1.00	74293	.75
74107	.30	74298	.85
74109	.45	74351	2.25
74110	.45	74365	.65
74111	.55	74366	.65
74116	1.55	74367	.65
74120	1.20	74368	.65
74121	.29	74376	2.20
74122	.45	74390	1.75
74123	.55	74393	1.35
74125	.45	74425	3.15
74126	.45	74426	.85
74128	.55	74490	2.55

CMOS

4000	.35	4528	1.25
4001	.35	4531	.95
4002	.25	4532	1.95
4006	.95	4538	1.95
4007	.29	4539	1.95
4008	.95	4543	2.70
4009	.45	4555	.95
4010	.45	4556	.95
4011	.35	4581	1.95
4012	.25	4582	1.95
4013	.45	4584	.95
4014	.95	4585	.95
4015	.95	4702	12.95
4016	.45	74C00	.35
4017	1.15	74C02	.35
4018	.95	74C04	.35
4019	.45	74C08	.35
4020	.95	74C10	.35
4021	.95	74C14	1.50
4022	1.15	74C20	.35
4023	.35	74C30	.35
4024	.75	74C32	.50
4025	.35	74C42	1.75
4026	1.65	74C48	1.20
4027	.65	74C73	.65
4028	.80	74C74	.85
4029	.95	74C76	.80
4030	.45	74C83	1.95
4034	2.95	74C85	1.95
4035	.85	74C86	.95
4040	.95	74C89	4.50
4041	1.25	74C90	1.75
4042	.75	74C93	1.75
4043	.85	74C95	1.75
4044	.85	74C107	1.00
4046	.95	74C150	5.75
4047	.95	74C151	2.25
4049	.55	74C154	3.25
4050	.55	74C157	1.75
4051	.95	74C160	2.00
4053	.95	74C161	2.00
4060	1.45	74C162	2.00
4066	.75	74C163	2.00
4068	.40	74C164	2.00
4069	.35	74C	

4116 16K DYNAMIC RAMS 250 NS 8/\$11⁹⁵ SET

ALL MERCHANDISE 100% GUARANTEED!

CALL US FOR VOLUME QUOTES

LINEAR				BI FET				EXAR			
LM301	.34	LM350K	5.60	NE570	4.75	LM1800	2.99	TL071	.79	XR 2206	3.75
LM301H	.79	LM350T	4.60	NE571	3.95	LM1812	8.25	TL072	1.19	XR 2207	3.85
LM307	.45	LM358	.98	NE592	2.75	LM1815	5.20	TL074	2.19	XR 2208	3.90
LM308	.98	LM359	1.79	LM703	.89	LM1818	2.90	TL081	.79	XR 2211	5.25
LM308H	1.15	LM376	3.75	LM709	.59	LM1820	3.50	TL082	1.19	XR 2240	3.25
LM309H	1.95	LM377	2.29	LM710	.75	LM1830	3.50	TL083	1.19		
LM309K	1.49	LM378	2.50	LM711	.79	LM1871	5.49	TL084	2.19		
LM310	1.75	LM379	4.50	LM723	.49	LM1872	5.49	LF347	2.19		
LM311	.64	LM380	1.29	LM723H	.55	LM1877	3.25	LF351	.60	CA 3010	.99
LM311H	.89	LM380N-8	1.10	LM733	.98	LM1889	2.49	LF353	1.00	CA 3013	2.00
LM312H	1.75	LM381	1.60	LM741N-8	.35	LM1896	1.75	LF355	1.10	CA 3023	2.75
LM317K	3.95	LM382	1.60	LM741N-14	.35	LM2877	2.05	LF356	1.10	CA 3035	2.49
LM317T	1.95	LM383	1.95	LM741H	.40	LM2878	2.25	LF357	1.40	CA 3039	1.29
LM318	1.49	LM384	1.95	LM747	.79	LM2900	.85			CA 3046	1.25
LM318H	1.59	LM386	1.50	LM748	.59	LM2901	1.00			CA 3053	1.45
LM319H	1.25	LM387	1.40	LM1014	2.75	LM3900	.59			CA 3059	2.90
LM319	1.25	LM389	1.35	LM1303	1.95	LM3905	1.25	TL494	4.20	CA 3060	2.90
LM320 (see 7900)		LM390	1.95	LM1304	1.19	LM3909	.98	TL496	1.65	CA 3065	1.75
LM322	1.65	LM392	.69	LM1305	1.49	LM3911	2.25	TL497	3.25	CA 3080	1.10
LM323K	4.95	LM394H	3.60	LM1307	.85	LM3914	3.95	75107	1.49	CA 3081	1.65
LM324	.59	LM399H	5.00	LM1310	2.90	LM3915	3.95	75188	1.25	CA 3082	1.65
LM329	.69	NE531	3.75	MC1330	1.89	LM3916	3.95	75189	1.25	CA 3083	1.55
LM331	3.95	NE536	6.00	MC1349	1.89	MC4024	3.95	75450	.59	CA 3086	.80
LM334	1.30	NE555	.39	MC1350	1.29	MC4044	4.50	75451	.39	CA 3089	2.99
LM335	1.40	NE556	.69	MC1358	1.79	RC4136	1.25	75452	.39	CA 3096	3.49
LM336	1.75	NE558	1.50	LM1414	1.59	RC4151	3.95	75453	.39	CA 3130	1.30
LM337K	3.95	NE561	19.95	LM1458	.69	LM4250	1.75	75454	.39	CA 3140	1.15
LM337T	2.95	NE562	6.00	LM1488	.99	LM4500	3.25	75491	.79	CA 3146	1.85
LM338K	6.95	NE564	3.95	LM1489	.99	LM13080	1.29	75492	.79	CA 3160	1.19
LM339	.99	LM565	.99	LM1496	.85	LM13600	1.49	75493	.89	CA 3401	.59
LM340 (see 7800)		LM566	1.49	LM1558H	3.10	LM13700	1.49	75494	.89	CA 3600	3.45
LM348	1.20	LM567	1.29								

VOLTAGE REGULATORS

7805T	.89	7905T	.99
7808T	.89	7908T	.99
7812T	.89	7912T	.99
7815T	.89	7915T	.99
7824T	.89	7924T	.99
7805K	1.39	7905K	1.49
7812K	1.39	7912K	1.49
7815K	1.39	7915K	1.49
7824K	1.39	7924K	1.49
78L05	.69	79L05	.79
78L12	.69	79L12	.79
78L15	.69	79L15	.79
78H05K	9.95	LM323K	4.95
78H12K	9.95	UA78540	1.95

T TO-220 K TO-3
L TO-92

TRANSISTORS DIODES

PN2222	TO-92	10/1.00	100/8.99
PN2907	TO-92	10/1.25	100/10.99
2N2222	TO-18	.25	50/10.99
2N2907	TO-18	.25	50/10.99
2N3055	TO-3	.79	10/6.99
3055T	TO-220	.69	10/5.99
2N3904	TO-92	10/1.00	100/8.99
2N3906	TO-92	10/1.00	100/8.99
1N4148 (1N914)		25/1.00	1000/35.00
1N4004		10/1.00	100/8.99

EXPAND YOUR TRS-80

16 DYNAMIC RAM KITS

SET OF 8

4116-200ns RAMS

\$13⁹⁵

INSTRUCTIONS FOR Model I Model III Color Computer to 16K Color Computer to 32K

\$1⁰⁰ EACH

DIP SHUNTS FOR YOUR MODEL I KEYBOARD

\$2⁹⁵ SET OF 2

ORDER TOLL FREE

800-538-5000

800-662-6279

(CALIFORNIA RESIDENTS)

IF YOU CAN FIND A PRICE LOWER ELSEWHERE, LET US KNOW AND WE'LL MEET OR BEAT THEIR PRICE! (SEE TERMS BELOW)

- ★ Computer managed inventory—virtually no back orders!
- ★ Very competitive prices!
- ★ Friendly staff!
- ★ Fast service — most orders shipped within 24 hours!

CABINET FOR 5 1/4" DISK DRIVE

- ★ COLOR MATCHES APPLE
- ★ FITS SHUGART

SPECIAL — \$29⁹⁵

THE MICROPROFESSOR

FROM MULTITECH \$149

Complete microprocessor training course — Teaches both hardware and machine language programming techniques — Includes Z80 computer!

- ★ Z80 based microcomputer with 36 key pad, 6 digit display, up to 4K on board RAM or 8K Eprom.
- ★ 140 page manual describes theory of operation and includes many experiments
- ★ Optional Eprom programmer and speech synthesizer boards available.

MICROCOMPUTER HARDWARE HANDBOOK

FROM ELCOMP — \$14.95

Over 800 pages of manufacturers data sheets on most commonly used IC's.

Includes:

- ★ TTL — 74/74LS and 74F
- ★ CMOS
- ★ Voltage Regulators
- ★ Memory — RAM, ROM, EPROM
- ★ CPU's — 6800, 6500, Z80, 8080, 8085, 8086/8
- ★ MPU support & interface — 6800, 6500, Z80, 8200 etc.

HOURS: M-F, 9-5; Sat. 11-3

VISIT OUR RETAIL STORE

JDR MICRODEVICES, INC.

1224 S. Bascom Avenue
San Jose, CA 95128

800-538-5000 • 800-662-6279 (CA)
(408) 995-5430 • Telex 171-110

PLEASE USE YOUR CUSTOMER NUMBER WHEN ORDERING

TERMS: For shipping include \$2 for UPS Ground or \$3 for UPS Blue Label Air. Items over 5 pounds require additional shipping charges. Foreign orders, include sufficient amount for shipping. There is a \$10 minimum order. Bay Area and Los Angeles Counties add 6 1/2% Sales Tax. Other California residents add 6% Sales Tax. We reserve the right to substitute manufacturer. Not responsible for typographical errors. Prices are subject to change without notice. We will match or beat any competitor's price provided it is not below our cost.

ALL MERCHANDISE 100% GUARANTEED!

CALL US FOR VOLUME QUOTES

**APPLE* II COMPUTER USERS
DISK DRIVE** ~~\$375⁰⁰~~ **\$299⁹⁵**

- ★ Includes metal cabinet
- ★ Color matches Apple
- ★ 35 Tracks/single side
- ★ Includes cable
- ★ Use with Apple II Controller

SPECIAL OFFER
Must State
"KILOBAUD Special"
When Ordering

16K RAM CARD \$69⁹⁵

- ★ Upgrade your 48K Apple II to full 64K of RAM.
- ★ Fully software and hardware compatible with the Apple language card and microsoft Z80 card.
- ★ Eliminates the need for the Applesoft or Integer Basic ROM card when used in conjunction with DOS 3.3.
- ★ Allows you to run Apple Fortran or Pascal with no difficulty.
- ★ Available as bare board, kit, or assembled and tested board.

BARE PC CARD — \$28.00 KIT — \$59.95

COOLING FAN \$69⁹⁵

- ★ Easy installation.
- ★ No modification of Apple required.
- ★ Color matches Apple.
- ★ Switch on front controls fan, computer and monitor.
- ★ Ultra-quiet, reliable fan.
- ★ Completely eliminates problems caused by overheating.



*Apple is a trademark of APPLE COMPUTER, INC.

**EPSON
PRINTERS**

**MX-80
MX-80FT
MX-100**

CALL FOR PRICE

WE HAVE APPLE AND TRS-80
INTERFACE CARDS AND CABLES

MONITORS

NEC JB-1201 M **\$169⁰⁰**

ZENITH ZVM-121 **\$119⁹⁵**

DISKETTES

5 1/4"

ATHANA SS SD SOFT **24.95**

MEMOREX SS SD SOFT **26.95**

VERBATIM SS SD SOFT **29.95**

VERBATIM 10 SECTION HARD **29.95**

8"

VERBATIM SS SD SOFT **44.95**

IBM* PERSONAL COMPUTER USERS

**MEMORY
EXPANSION CARD**

- ★ 64K - 192K.
- ★ Full single-bit error correction circuitry (ECC) assures reliable memory.
- ★ Fully IBM hardware and software compatible.
- ★ Highest quality PC card.
- ★ Price includes: PC card, card guide, ECC ROM, and manual

BARE PC CARD \$120.00

**DUAL SERIAL CARD
WITH GAME ADAPTER**

- ★ 2 Asynchronous RS232 Serial Ports.
- ★ Game adapter port.
- ★ Fully IBM compatible.
- ★ Replaces 2 IBM Asynchronous Communication Adapter cards.
- ★ Price includes: PC card, Prom, Mounting Bracket and Manual.

BARE PC CARD \$60.00

TM100-1 DISK DRIVE \$229⁰⁰

*IBM is a trademark of INTERNATIONAL BUSINESS MACHINES

HOURS:
M-F, 9-5; Sat. 11-3
**VISIT OUR
RETAIL STORE**



JDR MICRODEVICES, INC.

1224 S. Bascom Avenue
San Jose, CA 95128
800-538-5000 • 800-662-6279 (CA)
(408) 995-5430 • Telex 171-110

PLEASE USE YOUR CUSTOMER NUMBER WHEN ORDERING
TERMS: For shipping include \$2 for UPS Ground or \$3 for UPS Blue Label Air. Items over 5 pounds require additional shipping charges. Foreign orders, include sufficient amount for shipping. There is a \$10 minimum order. Bay Area and Los Angeles Counties add 6 1/2% Sales Tax. Other California residents add 6% Sales Tax. We reserve the right to substitute manufacturer. Not responsible for typographical errors. Prices are subject to change without notice. We will match or beat any competitor's price provided it is not below our cost.

WAMECO

THE COMPLETE PC BOARD HOUSE EVERYTHING FOR THE S-100 BUSS

TWO NEW BOARDS

CRT-1 VIDEO BOARD

- * SIMULATES INTELLIGENT TERMINAL
- * SEPARATE & COMPOSITE VIDEO
- * LT.PEN INTERFACE
- * 4K X 8 DISPLAY RAM
- * APL PROM LOCATION
- * 4K X 4 ATTRIBUTE RAM
- * 2K OR 4K OF PROGRAM LOCATION
- * KEYBOARD INTERFACE

PCBD.....	\$40.95
KIT.....	\$259.95
A & T.....	\$319.95

MEM-4, RAM/ROM 65K X 8

- * USES TMN 2016 - TMS 4016 RAMS OR 2716 EPROM IN ANY LOCATION
- * EXTENDED ADDRESSING
- * EXPANDABLE IN 2K BLOCKS
- * HCMOS COMPATABLE FOR ALL SUPPORT
- * BI - DIRECTIONAL BUSSING AVAILABLE ON DI OR DO LINES (SAME MEM-3)
- * BANK SELECTABLE USING EXTENDED ADDRESSING ON UPPER PORTION OF MEMORY

PCBD.....	\$40.95
KIT (LESS RAM).....	\$109.95
A & T LESS RAM.....	\$139.95

NOW DISTRIBUTING FOR EXTEK. EXTEK-64 EXPANSION FOR SSM'S PB-1. PROGRAMS 2732, 2732A AND 2764. ON THE PB-1 BANK DISABLE FOR PROGRAMMING SOCKET, SOCKETS EXTENDS ABOVE THE PB-1 SO NO EXTENDER IS REQUIRED. CP/M COMPATABLE SOFTWARE DISC IS INCLUDED.
KIT..... \$115.95, A & T..... \$129.95

**FOR 24 X 80 OR 36 X 80 INITIALIZATION FIRMWARE CHANGES FOR CRT-1
PLEASE SEND SELF ADDRESSED STAMPED ENVELOPE.**



WAMECO, INC., P. O. BOX 877 • EL GRANADA, CA 94018 • (415) 728-9114



CALIFORNIA COMPUTER SYSTEMS

\$100	
2032 32K STATIC RAM A & T 200 NSEC	\$468.00
2116 16K STATIC RAM A & T 200 NSEC	\$279.50
2065 64K DYNAMIC RAM A & T	\$351.00
2200 S-100 MAIN FRAM A & T	\$500.00
2422A FLOPPY DISC WITH CP/M 2.2	\$372.50
2831A ARITHMETIC PROCESSOR A & T	\$552.50
2810A Z80 CPU A & T	\$281.25
2710A 4 SERIAL I/O A & T	\$291.95
2501A 12 SLOT MOTHER BOARD	\$180.00
2720A 4 PARALLEL A & T	\$214.95
PROTO BOARDS WW	\$39.95

APPLE PRODUCTS

7114A 12K ROM/PROM	\$99.95
7424A CALENDAR/CLOCK	\$106.95
7440A PROGRAMMABLE TIMER	\$106.95
7470A A TO D CONVERTER	\$105.95
7490A GPIB (IE 488) INTERFACE	\$182.00
7710A ASYNC SERIAL	\$125.95
7712A SYNC SERIAL	\$148.50
7720A PARALLEL STANDARD	\$105.00
7720B PARALLEL CENTRONICS	\$105.00
7811B ARITHMETIC PROCESSOR W/DISC	\$325.00
7811C ARITHMETIC PROCESSOR W/ROM	\$325.00
7520A EXTENDER	\$23.50
7300A APPLE CLIP	\$8.00

SOFTWARE

23-01 CP/M™ MACRO ASSEMBLER ON DISK	\$76.95
24-01 CP/M™ SYMBOLIC INSTRUCTION DEBUGGER	\$64.25
25-01 CP/M™ TEXT FORMATER	\$64.25
26-01 CP/M™ BACKGROUND PRINT UTILITY	\$42.95

OTHER CCS PRODUCTS ARE AVAILABLE
CALL FOR PRICE



MICROCOMPUTER PRODUCTS

\$100 PRODUCTS

CB1A 8080 PROCESSOR PCBD	\$32.95
KIT \$155.95, A & T	\$215.95
CB-2 280 PROCESSOR BOARD	
KIT \$198.95, A & T	\$269.95
VBIC 64 x 16 VIDEO, PCBD	\$32.95
KIT \$153.95, A & T	\$199.95
VB2 64 x 16 VIDEO, PCBD	\$32.95
KIT \$175.95, A & T	\$234.95
VB3 80 CHARACTER VIDEO 4MHZ	
KIT \$345.95, A & T	\$425.95
UPGRADE RAMS FOR VB-3	\$42.00
I04 2 PARALLEL 2 SERIAL PCBD	\$32.95
KIT \$160.95, A & T	\$199.95
PB-1 2708 2716 PROGRAMMER BOARD	
KIT \$140.95, A & T	\$189.95
MB-10 16K STATIC RAM	
KIT \$299.95, A & T	\$339.95

APPLE PRODUCTS

A488 IEEE 488 INTERFACE	\$399.95
A10 - II SERIAL/PARALLEL INTERFACE A & T	\$178.00
ASIO SERIAL I/O A & T	\$115.95
API0 PARALLEL I/O W/O CABLES A & T	\$87.95

OTHER SSM PRODUCTS ARE AVAILABLE
CALL FOR PRICES

MIKOS

MONDAY-FRIDAY 8:00 TO 12:00, 1:00 TO 5:30
THURSDAYS 8:00 TO 9:00 P.M.

(415) 728-9121

P.O. BOX 955 • EL GRANADA, CA 94018

PLEASE SEND FOR IC, XISTOR AND COMPUTER PARTS LIST

SEPT SPECIAL SALE ON PREPAID ORDERS

(CHARGE CARDS C.O.D. OR P.O. NOT AVAILABLE)
MUST MENTION AD FOR SPECIAL PRICES

WAMECO CRT-1 WITH MIKOS PARTS.

KIT	\$199.95, A & T	\$259.95
WAMECO MEM - 3 WITH MIKOS PARTS LESS RAM KIT	\$85.95, A & T	\$119.95



WAMECO INC.

BOARDS WITH MIKOS PARTS

MEM-3 32K STATIC RAM, PCBD	\$36.95	
KIT LESS RAM	\$95.95, A & T	\$135.95
CPU-2 Z80 PROCESSOR, PCBD	\$32.95	
KIT LESS ROM	\$109.95, A & T	\$149.95
EPM-2 16K/32K EPROM, PCBD	\$32.95	
KIT LESS ROM	\$65.95, A & T	\$99.95
FPB-1 FRONT PANEL, PCBD	\$48.50	
KIT	\$144.95, A & T	\$184.95
CRT-1 36 OR 24 x 80 VIDEO BOARD, PCBD	\$38.95	
KIT	\$249.95, A & T	\$299.95
MEM-4 65K RAM/ROM BOARD, PCBD	\$38.95	
KIT LESS MEMORY	\$99.95, A & T LESS MEMORY	\$129.95

OTHER WAMECO PRODUCTS ARE AVAILABLE.
CALL FOR PRICES.

MIKOS PARTS ASSORTMENTS ARE ALL FACTORY MARKED PARTS. KITS INCLUDE ALL PARTS LISTED AS REQUIRED FOR THE COMPLETE KIT LESS PARTS LISTED ALL SOCKETS INCLUDED.

LARGE SELECTION OF LS TTL AVAILABLE.

PURCHASE \$50.00 WORTH OF LS TTL AND GET 10% CREDIT TOWARD ADDITIONAL PURCHASES. PREPAID ORDERS ONLY.

VISA or MASTERCHARGE. Send account number, interbank number, expiration date and sign your order. Approx. postage will be added. Orders with check or money order will be sent post paid in U.S. If you are not a regular customer, please use charge, cashier's check or postal money order. Otherwise there will be a two-week delay for checks to clear. Calif. residents add 6.5% tax. Money back 30-day guarantee. We cannot accept returned IC's that have been soldered to. Prices subject to change without notice. \$20 minimum order. \$2.00 service charge on orders less than \$20.00.

WE WILL NOT BE UNDERSOLD

SOFTWARE

MICROPRO	
Wordstar	\$269.00
Mailmerge	89.00
Customization Notes	\$359.00
Spellstar	\$239.00
Datastar	\$199.00
Calcstar	\$199.00
MICROSOFT	
Basic Interpreter	\$349.00
Basic Compiler	\$389.00
Fortran 80	\$499.00
Cobol 80	\$695.00
DATA BASE	
FMS80	\$595.00
dBase II	\$599.00

NEW! IBM PC SOFTWARE NEW!

INFORMATION UNLIMITED	
Easy Writer	\$289.00
Easy Speller	\$149.00
Easy Filer	\$319.00
VISICORP	
Visicalc 256K	\$190.00
VisiDex	\$199
VisiFile	\$229
VisiTrend/VisiPlot	\$229
MICROPRO	
Wordstar	\$299.00
MISCELLANEOUS	
Supercalc by Sorcim	\$229.00
Superwriter by Sorcim	\$289.00
Home Accountant Plus	\$139.00
ENTERTAINMENT	
Deadline	\$39.00
Temple of Apsah	\$29.00
Curse of Ra	\$15.99
Call For More IBM Software And Accessories	

DISK DRIVES

CCI 100 for the TRS-80 Model 1	
5 1/4 40 track	\$299.00
CCI 189 for the Zenith Z-89	
5 1/4 40 track	\$379.00
CORVUS 5M with Mirror	\$3089.00
CORVUS 10M with Mirror	\$4489.00
CORVUS 20M with Mirror	\$5389.00
CORVUS Interfaces	CALL
RANA SYSTEMS add-on Disk Drive for the Apple II	CALL
Elite One 40 Track	CALL
Elite Controller	CALL
Elite Two 80 Track	CALL
Elite Three 80 Track double-sided	CALL

DISKETTES

Maxell 5 1/4 single side	\$39.00
Maxell 8 single side	\$49.00
Maxell 5 1/4 double side	\$45.00
Maxell 8 double side	\$55.00
BASF 5 1/4	\$26.95
BASF 8	\$36.00
Verbatim 5 1/4	\$26.95
Verbatim 8	\$36.00
Wabash 5 1/4	\$24.95
Wabash 8	\$29.95

IBM PC ACCESSORIES

64K Card by Microsoft	\$435.00
Joystick by T & G	\$49.00
128K Card	\$579.00
192K Card	\$629.00
256K Card	\$699.00
Combo Card by Appar	\$249.00
Call for more IBM PC add-ons	

For fast delivery, send certified checks, money orders, or call to arrange direct bank wire transfers. Personal or company checks require one to three weeks to clear. All prices are mail order only and are subject to change without notice. Call for shipping charges.

APPLE SOFTWARE

MICROPRO	
Wordstar	\$269.00
MailMerge	\$99.00
Spellstar	\$149.00
DataStar	\$199.00
Calcstar	\$189.00
Supersort I	\$159.00
VISICORP	
VisiCalc	\$199.00
VisiTerm	\$79.00
VisiDex	\$199.00
VisiPlot	\$169.00
VisiFile	\$199.00
VisiSchedule	\$259.00
VisiTrend/Plot	\$239.00
VisiPac	\$539.00
MISCELLANEOUS	
Micro Courier	\$219.00
Screen Director	\$129.00
Executive Briefing System	\$169.00
Supercalc	\$99.00
Personal Filing System	\$115.00
PFS Report Writer	\$75.00
Word Handler	\$169.00
CP/M Power	\$59.00
ENTERTAINMENT	
Wizard and Princess	\$29.00
Twerps	\$28.00
Beer Run	\$28.00
Zork I, II	\$26.95
Deadline	\$39
Chop Lifter	\$24.95
Pinball	\$24.95
Cannonball Blitz	\$29.95
Knights of Diamonds	\$29.95
Midnight Magic	\$32.00
Wizardry	\$45.00
Time Zone	\$79.00
Tuesday Morning Quarterback	\$24.95
Crush, Crumble & Chomp	\$24.95
Datestones of Ryn	\$15.99
Morloc's Tower	\$15.99
Star Warrior	\$31.99
Snack Attack	\$23.95
Star Blazer	\$24.95
Kabul Spy	\$29.95
Cyclod	\$23.95

APPLE ACCESSORIES

ADVANCED LOGIC	
Add-Ram 16K Card	\$99.00
Z-Card CP/M for the Apple II	\$225.00
Smarterm 80 Column Board w/Softswitch	\$249.00
The Synergizer	
All of the above plus "The CP/M Handbook"	\$545.00
Z-80 Card by Microsoft	\$319.00
16K Card by Microsoft	\$159.00
32K Card by Saturn	\$199.00
Keyboard Enhancer II by Videx	\$125.00
Videoterm by Videx	\$259.00
Game Paddles by TG	\$49.00
Joystick by TG	\$49.00
Numeric Keypad by Keyboard Co.	\$139.00
ALF 9 Voice Board	\$159.00
ALF 3 Voice Board	\$229.00
System Saver by Kensington	\$75.00
Versacard by Prometheus	\$229.00
8088 Card by Coprocessor	\$789.00
Microbuffer II 16K w/graphics	\$259.00
Microbuffer II 32K w/graphics	\$299.00
APPLE INTERFACE CARDS BY CCS	
Serial Asynch. #7710	\$139.00
Serial Synch. #7712	\$149.00
Call for other CCS cards	

RAM

16K Ram Kit for Apple II; TRS80	\$17.50
200 nano seconds, 4116 chips	

COMPUTERS

CALIFORNIA COMPUTER SYSTEM	
Mainframe 2200a	\$485.00
Z-80 CPU 2810a	\$265.00
64K RAM 2065	\$569.00
Floppy Controller 2422a	\$359.00
ZENITH	
Z-89 48K	CALL
Z-90 64K	CALL
Call For Prices On The Complete Zenith Line	
CASIO FX702P Pocket Computer	\$179.00
Sanyo MBC1000 64K	\$1649
Call For Prices On Complete Sanyo Computer Line	

PRINTERS

NEC 7710 Serial	\$2395.00
NEC 7720 KSR	\$2749.00
NEC 7730 Parallel	\$2395.00
NEC 3510 Serial	\$1850.00
NEC 3530 Parallel	\$1850.00
NEC 8023 Dot Matrix 100cps	\$539.00
Olivetti DY211 Letter Quality	
Daisy Wheel Printer	\$1095.00
Parallel Only	\$995.00
Epson MX-80	CALL
Epson MX-80FT	CALL
Epson MX-100	CALL
IDS 580	CALL
IDS Prism 80	CALL
IDS Prism 132	CALL
Okidata Microline 80	CALL
Okidata Microline 82A	CALL
Okidata Microline 83A	CALL
Okidata Microline 84	CALL
Centronics 739	\$675.00
Datasouth 180 cps	CALL
Zenith Z-25 150 cps	CALL

MONITORS

Amdek 12" B & W	\$109.00
Amdek 13" Color	\$329.00
Sayno 9" B&W	\$135.00
Sayno 9" Green	\$140.00
Sayno 12" B&W	\$179.00
Sayno 12" Green	\$189.00
Sanyo 13" Color	\$359.00
Zenith 12" Green	\$99.00
Zenith 13" Color	\$339.00
Electrohome 13" HI-RES	
Color Monitor	\$829.00
Electrohome 13" Color	\$349.00
Electrohome 12" B&W	\$179.00
Electrohome 12" Green	\$189.00
Electrohome 9" B&W	\$149.00
Electrohome 9" Green	\$159.00

SPECIAL OF THE MONTH
RANA SYSTEMS
add-on disk drive for Apple II
Elite One 40 track CALL

TERMINALS

ADDS Viewpoint	\$495.00
Zenith Z-19	\$679.00
Televideo 910	\$595.00
Televideo 925	\$779.00
Televideo 950	\$969.00

TELECOMMUNICATIONS

Prentice Star Modem	\$129.00
Novation Cat Modem	\$139.00
Novation D-CAT	\$149.00
Novation AUTO-CAT	\$199.00
Novation APPLE CAT	\$299.00
Hayes Smart Modem	\$249.00
Hayes Micro-Modem	\$295.00
Hayes Chronograph	\$225.00

The CPU Shop

TO ORDER CALL TOLL FREE 1-800-343-6522

420-438 Rutherford Ave., Dept.

Charlestown, Massachusetts 02129



Hours 9 AM - 9 PM (EST) Mon.-Fri. (Sat. till 6)
 Technical information call 617/242-3361

TWX- 710-348-1796

Massachusetts Residents call 617/242-3361
 Massachusetts Residents add 5% Sales Tax

JE600 Hexadecimal Encoder Kit

FULL 8-BIT LATCHED OUTPUT 19-KEY KEYBOARD

The JE600 Encoder Keyboard Kit provides two separate hexadecimal digits produced from sequential key entries to allow direct programming for 8-bit microprocessor or 8-bit memory circuits. Three additional keys are provided for user operations with one having a bistable output available. The outputs are latched and monitored with 9 LED readouts. Also included is a key entry strobe. Features: Full 8-bit latched output for microprocessor use. Three user-definable keys with one being bistable operation. Debounce circuit provided for all 19 keys. 9 LED readouts to verify entries. Easy interfacing with standard 16-pin IC connector. Only +5VDC required for operation. Size: 3 1/2" H x 8 1/2" W x 8 3/4" D

JE600/DTE-HK (After assembled as pictured above) ... \$99.95
 JE600 Kit 19-Key Hexadec. Keyboard, PC Board & Cmpnts. (no case) ... \$59.95
 K19 19-Key Keyboard (Keyboard only) ... \$14.95
 DTE-HK (case only - 3 1/2" H x 8 1/2" W x 8 3/4" D) ... \$44.95

JE610 ASCII Encoded Keyboard Kit

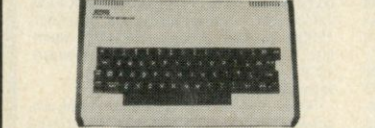

The JE610 ASCII Keyboard Kit can be interfaced into most any computer system. The kit comes complete with an industrial grade keyboard switch assembly (62-keys), IC's, sockets, connector, electronic components and a double-sided printed wiring board. The keyboard assembly requires +5V @ 150mA and -12V @ 10 mA for operation. Features: 60 keys generate the 126 characters, upper and lower case ASCII set. Fully buffered. Two user-definable keys provided for custom applications. Caps lock for upper-case-only alpha characters. Utilizes a 2376 (40-pin) encoder read-only memory chip. Outputs directly compatible with TTL/DTL or MOS logic arrays. Easy interfacing with a 16-pin dip or 18-pin edge connector. Size: 3 1/2" H x 14 1/2" W x 8 3/4" D

JE610/DTE-AK (After assembled as pictured above) ... \$124.95
 JE610 Kit 62-Key Keyboard, PC Board, & Components (no case) ... \$ 79.95
 K62 62-Key Keyboard (Keyboard only) ... \$ 34.95
 DTE-AK (case only - 3 1/2" H x 11" W x 8 3/4" D) ... \$ 49.95

JE212 - Negative 12VDC Adapter Board Kit for JE610 ASCII KEYBOARD KIT Kit/Provides -12V DC from incoming 5VDC ... \$9.95

JE215 Adjustable Dual Power Supply

General Description: The JE215 is a Dual Power Supply with independent adjustable positive and negative output voltages. A separate adjustment for each of the supplies provides the user unlimited applications for IC current voltage requirements. The supply can also be used as a general all-purpose variable power supply.

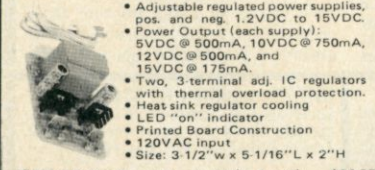

FEATURES:
 • Adjustable regulated power supplies, pos. and neg. 1.2VDC to 15VDC.
 • Power Output (each supply): 5VDC @ 600mA, 10VDC @ 750mA, 12VDC @ 500mA, and 15VDC @ 175mA.
 • Two, 3-terminal adj. IC regulators with thermal overload protection.
 • Heat sink regulator cooling
 • LED "ON" indicator
 • Printed Board Construction
 • 120VAC input
 • Size: 3 1/2" w x 5 1/16" L x 2" H

JE215 Adj. Dual Power Supply Kit (as shown) ... \$24.95
 (Picture not shown but similar in construction to above)
 JE200 Reg. Power Supply Kit (5VDC, 1 amp) ... \$14.95
 JE205 Adapter Brd. (to JE200) \$5.99 & ±12V ... \$12.95
 JE210 Var. Pwr. Sply. Kit, 5-15VDC, to 1.5amp. ... \$19.95

HP-Display Sale-National 5082 Series - 0.43 Inch - 7-Segment

Part Number	Color	Description	1-3 Price	SALE PRICE
5082-7650	Hi Eff Red	CA - LHD	99	4/\$2.49
5082-7651	Hi Eff Red	CA - RHD	99	4/\$2.49
5082-7653	Hi Eff Red	CC - RHD	99	4/\$2.49
5082-7656	Hi Eff Red	Overflow ±1RHD	99	4/\$2.49
5082-7660	Yellow	CA - LHD	99	4/\$2.49
5082-7661	Yellow	CA - RHD	99	4/\$2.49
5082-7663	Green	CC - RHD	99	4/\$2.49
5082-7670	Green	CA - LHD	99	4/\$2.49
5082-7671	Green	CA - RHD	99	4/\$2.49
5082-7673	Green	CC - RHD	99	4/\$2.49
5082-7676	Green	Overflow ±1RHD	99	4/\$2.49
5082-7750	Red	CA - LHD	99	4/\$2.49
5082-7751	Red	CA - RHD	99	4/\$2.49
5082-7756	Red	Overflow ±1RHD	99	4/\$2.49
5082-7760	Red	CC - RHD	99	4/\$2.49

CA-Comm. Anode CC-Comm. Cathode LHD/RHD/Left/Right hand dec.

Mini Stereo AM/FM Receiver

WITH HEADPHONES For Joggers, Cyclists, Skaters & Sports Events

FEATURES: Lightweight headphones. Left/right balance control. Full fidelity stereo sound. Additional black soft carrying case & shoulder strap. Belt clip (hands free). Operates on 3 AA cell batteries (not incl.). Compact size: 3 1/2" x 4 1/4" x 1". Wt. 6 oz.

Model 2830 ... \$29.95

KEYBOARDS - POWER SUPPLIES

ALPS 26-KEY CALCULATOR KEYBOARD
 Features: 7 Position, 3 Functions and 2 Position Switches (ON/OFF). These are from Olivetti's Top of the Line. Mechanical SPST Switching; 22-pin Edge Card Connection. ... \$1.95 each or 2/\$3.49

MICRO SWITCH 69-KEY KEYBOARD
 Data Entry Keyboard. Encoded Output: 6-bit Parallel EBC DIC. Switching: Half Effect. 24-pin Edge Card Connection. Complete with Pin Connector. ... \$19.95 each

DATANETICS 74-KEY KEYBOARD
 ASCII Encoded Keyboard. Even Parity ASCII. Supply voltage +5, -12 volt. Switching: Mechanical SPST - 50-pin Connection. Complete with Pin Connector. ... \$29.95 each

MICRO SWITCH 85-KEY KEYBOARD
 Data Entry Keyboard. Encoded Output: 16-bit Parallel EBC DIC. Switching: Half Effect. 24-pin Edge Card Connection. Supply Voltage +5VDC. Main Keyboard is QWERTY. Additional Key Pads for Cursor and word processing functions. ... \$29.95 each

MICRO SWITCH 88-KEY KEYBOARD (PARALLEL ASCII)
 Data Entry Keyboard. Encoded Output: 16-bit Parallel ASCII. Supply Voltage +5V, -12V. Switching: Half Effect. 19-pin Edge Card Connection. Schematic included. Uses 8048 Encoder Chip. ... \$69.95 each

POWER SUPPLY - 5VDC @ 1 AMP REGULATED
 Transaction Tech Output +5VDC @ 1 amp (plus ±30VDC) reg. Input: 115VAC 60Hz. Two-time (black/white) self-enclosed case. 5 ft. 3-wire. black power cord. Size: 6 1/2" W x 7 1/2" D x 2 1/4" H. Wt. 3 lbs. Part No. PS1194 ... \$19.95 each

POWER SUPPLY - 5VDC @ 1 AMP REGULATED
 B Industries Output +5VDC @ 1 amp, +36-42VDC adj. 400mA or less. 30VAC (incl.) @ 1.5 amp. Input: 115VAC 60Hz. Circ. break. reset button. 8 1/2" x 3-wire. black power cord. Size: 6 1/2" W x 7 1/2" D x 2 1/4" H. Wt. 3 lbs. Part No. PS407D ... \$24.95 each

POWER SUPPLY - 5VDC @ 7.5 AMP. 12VDC @ 1.5 AMP SWITCHING
 Input: 115VAC, 50-60Hz @ 3 amp/230VAC, 50Hz @ 1.5 amp. Fan w/ty. power supply select switches (115/230VAC). Output: 5VDC @ 7.5 amp, 12VDC @ 1.5 amp. 8 ft. blk. pow. cord. 11 1/2" W x 13 1/2" D x 3 1/4" H. Wt. 6 lbs. Part No. PS94VD ... \$49.95 each

POWER PAC - Heavy Duty Multi-Voltage Power Supply - 5VDC, 12VDC, 24VDC
 Output: +5VDC @ 30A, +12VDC @ 2A, -12VDC @ 4A & +24VDC @ 3A. Input: 115VAC, 7A, 220VAC, 3.5A. Reg. ±. 15% line & load. com. Ripple: 10mV peak-to-peak (30% RMS). Overv. protect. 9V, 12V, 15V. Overv. protect. incl. 15 1/2" L x 8 1/2" W x 11 7/8" D. Wt. 40 lbs. Part No. 285-016 ... \$89.95 each

SORENSEN Regulated Power Supplies

Sorenson's open construction (SOC) power supplies are series-regulated solid-state systems, designed to provide reg. DC voltages at 6 levels (2-28 vrange). These units are open-framed on sturdy black anodized aluminum for excellent mounting. FEATURES: 115/200/230VAC Input @ 50-63Hz. Low Ripple: 1.5mVrms. Slew P max. adjustable current limit. Voltage adjustment control. All schematics and specifications supplied with unit. Series A,B,C,E have three mounting surfaces (Series F, bottom mounting only).

Part No.	Series	Output Voltage Adjustment Range (min. - max.)	Output Current (amps) (Ave) @ 50°C	Size (Inches)	Weight	Price
SOC 2-6	B	1.9 - 2.1	0.0	3.8	5.62 x 4.88 x 2.60	4.3 lbs. \$18.95
SOC 2-75	F	1.9 - 2.1	25.0	21.5	17.5 x 16.00 x 4.88 x 4.88	16 lbs. 29.95
SOC 5-3	A	4.25 - 5.25	0.0	3.8	4.00 x 4.88 x 1.62	2 lbs. 24.95
SOC 5-18	E	4.25 - 5.25	18.0	15.0	12.0 x 14.00 x 4.88 x 2.75	12 lbs. 39.95
SOC 5-25	F	4.25 - 5.25	25.0	21.5	17.5 x 16.00 x 4.88 x 4.88	16 lbs. 49.95
SOC 12-11	E	11.4 - 12.6	11.0	9.2	6.6 x 16.00 x 4.88 x 1.62	12 lbs. 44.95
SOC 12-15	F	11.4 - 12.6	15.0	12.5	9.5 x 16.00 x 4.88 x 4.88	16 lbs. 49.95
SOC 15-5	C	14.25 - 15.75	5.0	4.2	3.5 x 7.00 x 4.88 x 3.37	6.6 lbs. 39.95
SOC 15-8	E	14.25 - 15.75	8.0	7.6	14.00 x 4.88 x 1.62	12 lbs. 44.95
SOC 15-13	F	14.25 - 15.75	13.0	10.5	9.0 x 16.00 x 4.88 x 4.88	16 lbs. 49.95
SOC 28-8	A	26.6 - 29.4	0.8	64	45 x 4.00 x 4.88 x 1.62	2 lbs. 24.95

Powertec Sub-Modular DC Power Supplies

SM Series power supplies include rectifying, filtering, regulating, overload and overvoltage protection functions. You need only connect the sub-module to the appropriate secondary transformer tap and bolt the unit to a heatsink.

Part No.	Input	Output	Power Transformer (Transformer Not Included)	Size (Inches)	Wt.	Price
22A-300	-100 to +140V to 7.5V	-300 to +105V to 10.5V	115-120VAC 17VAC 5A no CT	2.50 x 3.00 x .98	2 oz.	\$14.95
22B-200	2.2A	1.7A	115-120VAC 22VAC 3A w/CT	3.00 x 5.75 x 1.18	8 oz.	14.95
22B-300	2.2A	1.7A	115-120VAC 28VAC 2.5A w/CT	2.75 x 5.75 x 1.18	8 oz.	19.95
22C-100	6.0A		115-120VAC 84VAC 8A w/CT	2.80 x 7.50 x 1.18	8 oz.	24.95
22C-500		2.5A	115-120VAC 48VAC 3A w/CT	2.80 x 7.50 x 1.18	8 oz.	24.95
22D-300		6.8A	115-120VAC 84VAC 10A w/CT	3.00 x 7.00 x 3.30	2 lbs.	24.95
22E-100	18.00A		115-120VAC 16VAC 24A w/CT	2.90 x 7.00 x 3.30	2 lbs.	29.95

*Voltage Adjustment Range - Current ratings apply over entire voltage range.

SHIPMENT IN 24 HOURS

6:00AM to 6:00PM (PST)
 Call: (415) 592-8097

JUMPER AND CABLE ASSEMBLIES

Part No.	Size (Inches)	Wt.	Price
D40-1	924132-12	40	single end 12" 5.89
D40-2	924132-24	40	single end 24" 6.79
D40-3	924132-36	40	single end 36" 7.69
D40-4	924136-12	40	double end 12" 10.95
D40-2-40	924136-24	40	double end 24" 12.79
D40-3-40	924136-36	40	double end 36" 12.79

STANDARD DB25 SERIES CABLES

Part No.	Cable Length	Connectors	Price
DB25P-4	4 feet	1 DB25P	\$ 9.95 ea.
DB25S-4	4 feet	1 DB25S	10.95 ea.
DB25P-4-P	4 feet	2 DB25P	16.95 ea.
DB25P-4-S	4 feet	1 DB25P/1 DB25S	17.95 ea.
DB25S-4-S	4 feet	2 DB25S	18.95 ea.

\$10.00 Minimum Order - U.S. Funds Only
 California Residents Add 6 1/2 % Sales Tax
 Postage - Add 5% plus \$1.50 Insurance
 Send S.A.S.E. for Monthly Sale Flyer!

Call for Quantity Discounts

Mail Order Electronics - Worldwide
ameco ELECTRONICS
 NEW! Telex Number 176043
 1355 SHOREWAY ROAD, BELMONT, CA 94002
 PHONE ORDERS WELCOME - (415) 592-8097

5 1/4" Mini-Floppy Disc Drive

FOR TRS-80 MODEL I, III (Industry Standard)
 Features single or double density. Recording mode: FM single, MFM double density. Power: +5VDC (±0.5V) 1.6 amps max. +5VDC (±0.25V) 0.8 amps max. Unit as pictured at left (does not incl. case, power supply or cables). 30-page data book included. Weighs 3 1/2 lbs. Quantity: Size 5 1/4" W x 8 1/2" x 3 1/2" H

Part No. Limited Quantity! Price
 FD200 Single-sided, 40 tracks, 250K bytes capacity ... \$179.95
 FD250 Double-sided, 35 tracks, 438K bytes capacity ... \$199.95

EXPAND YOUR TRS-80 TO 16K, 32K OR 48K

**Model 1 = From 4K to 16K Requires (1) One Kit
 Model 3 = From 4K to 48K Requires (3) Three Kits
 Color = From 4K to 16K Requires (1) One Kit
 **Model 1 equipped w/Expansion Board up to 48K (2) Two Kits Req'd. - One Kit Required for each 16K of Expansion -

TRS-80 16K Conversion Kit - Kit comes complete with 8 each MMS280 (UP0416/4116) 16K Dynamic RAM (1's) & documentation for conversion. TRS-16K2 150ns ... \$16.95
 TRS-16K3 200ns ... \$14.95
 TRS-16K4 250ns ... \$10.95

Pee Wee Boxer Fan

• 36cm free air delivery
 • 3.125" sq. x 1.665" depth
 • 10 yrs. cont. duty at 20°C
 • 115V 50/60Hz
 • For Apple users
 PWS1207U Cleaned & tested used ... \$ 7.95 ea.
 PWS2107F New ... \$12.95 ea.

Muffin Fan

• 105cm free air delivery
 • 4.68" sq. x 1.50" depth
 • 10 yrs. cont. duty at 20°C
 • Impedance protected, ambients to 70°C
 • 115V 50/60Hz 14W Wt. 17 oz.
 MUZAI-1U Cleaned & tested used ... \$ 7.95 ea.
 MUZAI-1N New ... \$12.95 ea.

1/2 Price Sale! - COMPUTER GRADE CAPACITORS - 1/2 Price Sale!

mfd	vvdc	price	mfd	vvdc	price	mfd	vvdc	price	mfd	vvdc	price
250	150	1.95	4,500	50	3.95	20,000	20	2.95	43,000	10	5.95
500	200	2.49	5,500	25	4.49	21,000	15	3.99	45,000	5	9.95
1,250	3	9.95	6,100	40	5.95	22,000	15	4.95	52,000	20	5.95
1,500	25	1.95	7,000	60	4.95	23,000	7	1.95	55,000	15	9.95
1,500	50	2.95	10,000	10	2.95	23,000	10	2.95	58,000	20	5.95
2,000	10	2.95	10,000	16	3.95	23,000	10	3.95	65,000	10	7.95
2,100	200	2.95	11,000	19	4.95	24,000	20	2.95	73,000	5	9.95
2,250	180	3.95	13,000	16	2.95	27,000	10	2.95	80,000	15	9.95
2,300	33	2.95	14,000	13	2.95	28,000	5	4.95	90,000	10	8.95
3,000	15	2.95	15,000	10	4.95	40,000	20	5.95	120,000	15	9.95
3,200	25	1.95	16,000	10	3.95	42,000	10	4.95	160,000	10	8.95
3,600	40	3.95									

JOYSTICKS

JS-5K 5K Linear Taper Pots ... \$5.25
 JS-100K 100K Linear Taper Pots ... \$4.95
 JS-150K 150K Linear Taper Pots ... \$4.75
 JVC-40 40K (2) Video Controller in Case ... \$4.95

UV-EPROM Eraser

8 Chips - 51 Minutes
 1 Chip - 37 Minutes

Erases 2708, 2716, 2732, 2764, 2516, 2532, 2564. Erases up to 8 chips within 51 minutes (1 chip in 37 minutes). Maintains constant exposure distance of one inch. Special conductive foam liner eliminates static build-up. Built-in safety lock to prevent UV exposure. Compact - only 9.00" x 3.70" x 2.60". Complete with holding tray for 8 chips.

UVS-11EX Replacement Bulb ... \$16.95

DE-4 UV-EPROM Eraser ... \$79.95

Mostek DC/DC Converter +5 VOLTS TO -9 VOLTS
 Input: +5V Output: -9V (regulated) @ 30mA
 Printed circuit mounting.
 DC10 ... \$2.95 ea. or 2/\$4.95

Wall Transformers AC and DC Types

Part No.	Input	Output	Price
AC 250 (above)	117V/60Hz	12VAC 250mA	\$3.95
AC 500	117V/60Hz	12VAC 500mA	\$4.95
AC1000	117V/60Hz	12VAC 1 amp	\$5.95
AC1700	117V/60Hz	9VAC 1.7 amp	\$3.95
AC9004	117V/60Hz	9.2VAC 2.5 amp	\$2.95 or 2/\$4.95
DC 800	120V/60Hz	6VDC 400mA	\$2.95 or 2/\$4.95
DC812	120V/60Hz	6.9,12VDC 300mA	\$9.95
DC5490	117V/60Hz	9.5VDC 275mA	\$2.49 or 2/\$3.95
DC900	120V/60Hz	9VDC 500mA	\$3.95
DC1200	120V/60Hz	12VDC 300mA	\$

7400

**Number of Pins of each I.C. for easy Socket purchase

MICROPROCESSOR COMPONENTS

*Evaluation Kits

INTERMIL



Table with columns: Part No., Pins, Price. Lists various 7400 series ICs like SN7400N, SN7401N, etc.

Table with columns: Part No., Pins, Price. Lists various Static RAMs like 1101, 2101, 4102, etc.

Table with columns: Part No., Pins, Price. Lists various Dynamic RAMs like 1103, 2102, 4102, etc.

Table with columns: Part No., Pins, Price. Lists various evaluation kits like 70454PI, 70456PK, etc.

Table with columns: Part No., Pins, Price. Lists various 74LS series ICs like 74LS00, 74LS01, etc.

Table with columns: Part No., Pins, Price. Lists various EPROMs like 2708, 2709, 2716, etc.

Table with columns: Part No., Pins, Price. Lists various Microprocessor Chips like 80C80, 80C86, etc.

Table with columns: Part No., Pins, Price. Lists various ROMs like 2913, 2914, etc.

Table with columns: Part No., Pins, Price. Lists various Microprocessor Manuals like M-280, M-COP1802, etc.

Table with columns: Part No., Pins, Price. Lists various 8000/8600 Support Devices like MC6800, MC6801, etc.

Table with columns: Part No., Pins, Price. Lists various 8080/8086 Bus Support Devices like IN8080A, DP8212, etc.

Table with columns: Part No., Pins, Price. Lists various Data Acquisition components like DC10, MC3407P, etc.

Table with columns: Part No., Pins, Price. Lists various 74S/PROMs like 74S00, 74S01, etc.

Table with columns: Part No., Pins, Price. Lists various 25 Pin - D Subminiature connectors like DB25, DB25K, etc.

Table with columns: Part No., Pins, Price. Lists various Solder Eject/Wire Wrap Edge Card connectors like 15/30SE, 18/36SE, etc.

Table with columns: Part No., Pins, Price. Lists various Linear ICs like LM002CN, LM101CN, etc.

Table with columns: Part No., Pins, Price. Lists various CA-Linear ICs like CA3010H, CA3020H, etc.

Table with columns: Part No., Pins, Price. Lists various IC Sockets like CD-4000, CD-4001, etc.

Table with columns: Part No., Pins, Price. Lists various Wire Wrap (Gold) Sockets like 8 pin WW, 14 pin WW, etc.

Table with columns: Value, Price. Lists various 50 Volt Ceramic Disc Capacitors like 10pF, 22pF, etc.

Table with columns: Part No., Pins, Price. Lists various CD-CMOS ICs like CD4000, CD4001, etc.

Table with columns: Part No., Pins, Price. Lists various IC Sockets like CD-4000, CD-4001, etc.

Table with columns: Value, Price. Lists various 100 Volt Mylar Film Capacitors like .001mf, .0022mf, etc.

Table with columns: Value, Price. Lists various 50 Volt Aluminum Electrolytic Capacitors like 100uF, 220uF, etc.

Blank white area with text: BLOWN... PRICES AS LISTED. Shipment in 24 Hours

CONNECTORS

IC SOCKETS

For Socket Required, See Column After The IC Part No.

Table with columns: LOW PROFILE (TIN) SOCKETS, WIRE WRAP (GOLD) SOCKETS, LEVEL #3. Lists socket types and prices.

Advertisement for Ameco Electronics, 1355 Shoreway Road, Belmont, CA 94002. Includes phone number 415-592-8097.

CAPACITOR CORNER

Table with columns: Value, Price. Lists various capacitor types and values like 50 Volt Ceramic Disc, 100 Volt Mylar Film, 50 Volt Aluminum Electrolytic.

SELECTRONICS

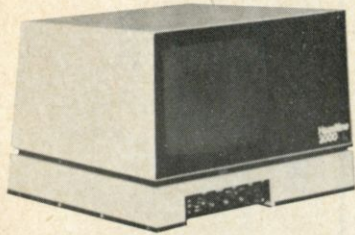

HAZELTINE 1000

- * 12 x 80 characters
- * shipping wt. 47lbs.
- * \$150.00 f.o.b. our warehouse

TEXAS INSTRUMENT 750

THERMAL PRINTERS

- * parallel interface
- * upper & lower case
- * excellent condition
- * shipping wt. 30lbs.
- * \$90.00 f.o.b. our warehouse

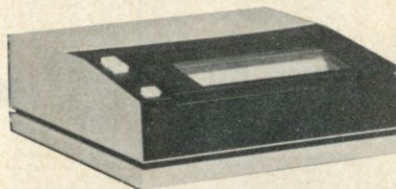

REGULATED DC POWER SUPPLIES MFGS. LAMBDA & NORTH

VOLTS	AMPS	WT.	PRICE
5	74	62#	\$40.00
5	31	40	\$35.00
5	16	18	\$23.00
5	10	18	\$15.00
5	4	7	\$10.00
5	13	20	\$20.00
12	10.5	18	\$30.00
12	7.3	18	\$25.00
12	1.6	9	\$10.00

20% discount for 5 or more.

CABLES

5' RG/59U cable with PL259 connector on one end.
Price: \$1.00 ea. 6/\$5.00

24" RG/59U cable with PL 259 connector on one end, BNC on other end.
Price: \$1.00 ea. 6/\$5.00

MODEM CABLES

DB-25 male to male \$6.00 ea. 2/\$10.00
DB-25 male to blank \$3.00 ea. 4/\$10.00
DB-25 female to blank \$3.00 ea. 4/\$10.00

SELECTRONICS

1229 S. Napa Street • Philadelphia PA 19146

Penna. resident please add 6% sales tax. ALL PRICES ARE F.O.B. our warehouse. Phila. PA. All merchandise accurate as to description to the best of our knowledge. Your purchase money refunded if not satisfied. Min. order \$10.00

Phone: 215-468-7891 215-468-4645

HAZELTINE 2000

- * 12" green phos tube
- * adjustable baud rate from front
- * remote keyboard w/numeric keypad
- * insert & delete, character & line mode, and cursor control functions
- * external printer & cassette ports
- * modem cable w/DB-25 connector
- * shipping wt. 65lbs.
- * \$300.00 f.o.b. our warehouse

HAZELTINE TAPE CASSETTES

- * dual tape drives
- * digitally records & duplicates
- * data files can be prepared off line
- * recording rate 2400 baud
- * records 400 bits per inch
- * tape speed 6" per second
- * shipping wt 33 lbs.
- * operators manual inc.
- * \$125.00 fob our warehouse

MONITORS

12" black & white monitor. Wide band, will display 80 x 24 char. 10K or 75Ω input impedance, composite video input. Transformer power supply.
Shpt. Wt. 30#
Price: \$55 ea.
Used with all computers such as: TRS-80, Apple, and many others.
Complete manual \$5.00.
(Also in green phos \$80.00 ea.)

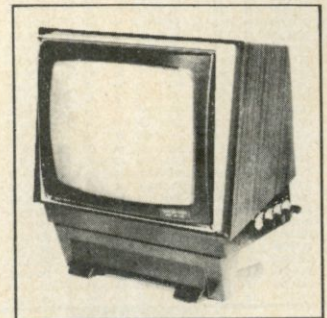

PERKIN-ELMER CAROUSEL 350 TERMINAL

Only Selectronics could bring you this unbelievable opportunity to own the finest high quality KSR terminal ever made. These machines originally listed for more than \$4200. Check these outstanding features:

- * Letter quality printing with upper and lowercase
- * Microprocessor controlled
- * 76-key alphanumeric keyboard with 10-key numeric pad
- * EIA RS232C asynchronous serial interface
- * 40 cps print rate
- * 132 character buffer



- * Full or half duplex
- * Parity—odd, even, none
- * Replacable print cups and elements

Excellent Condition— \$650.00 f.o.b.
Shpt. Wt. 100# our warehouse

MULTIPLE VOLTAGE COMPUTER GRADE NORTH POWER SUPPLY

+ 5VDC @ 25A + 12VDC @ 3A
- 5VDC @ 4A - 12VDC @ 2A

shipping wt. 30lbs.

\$35.00 f.o.b. our warehouse

ASCII ENCODED KEYBOARDS

SOLID STATE KEYS CONTOURED TYPEING SURFACE
"N" KEY ROLL-OVER.

Documentation Included
Shipping Wt. 7#

\$25.00 w/o case f.o.b. our warehouse
\$35.00 w/ case f.o.b. our warehouse

Muffin fans
\$3.00 ea. 10" fans Sonarlerts
6 for \$15.00 \$9.00 \$2.00 ea.

Yes—We do accept VISA & Mastercard

FOR ONLY \$129.95 Learn Computing From The Ground Up

Build a Computer kit that grows with you, and can expand to 64k RAM, Microsoft BASIC, Text Editor/Assembler, Word Processor, Floppy Disks and more.

EXPLORER/85

Here's the low cost way to learn the fundamentals of computing. The important basics you'll need more and more as you advance in computer skills. For just \$129.95 you get the advanced-design Explorer/85 motherboard, with all the features you need to learn how to write and use programs. And it grows into a system that is a match for any personal computer on the market. Look at these features: 8085 Central Processing Unit, the microprocessor "heart" of the Explorer/85. (Join the millions who will buy and use the 8080/8085 this year alone!) Fast 1-bit plus one 6-bit input/output ports from which you can input and output your programs, as well as control exterior switches, relays, lights, etc. a cassette interface that lets you store and reload programs you've learned to write. deluxe 2,000 byte operating system/monitor makes it easy to learn computing in several important ways. It allows simpler, faster writing and entering of programs. It permits access by you to all parts of the system so you can check on the status of any point in the program. It allows tracing each program step by step, with provision for displaying all the contents of the CPU (registers, flags, etc.) and it does much more!

You get all this in the starting level (Level A) of the Explorer/85 for only \$129.95. Incredible! To use, just plug in your 8VDC power supply and terminal or keyboard/display — if you don't have them, see our special offers below.

Level A computer kit (Terminal Version) ... \$129.95 plus \$3 P&I*
 Level A kit (Hex Keypad/Display Version) ... \$129.95 plus \$3 P&I*

LEVEL B — This "building block" converts the motherboard into a two-slot 5100 bus (industry standard) computer. Now you can plug in any of the hundreds of 5100 cards available.

Level B kit ... \$49.95 plus \$2 P&I*
 5100 bus connectors (two required) ... \$4.85 each, postpaid.

LEVEL C — Add still more computing power. This "building block" mounts directly on the motherboard and expands the 5100 bus to six slots.

Level C kit ... \$39.95 plus \$2 P&I*
 5100 bus connectors (five required) ... \$4.85 each, postpaid.

LEVEL D — When you reach the point in learning that requires more memory, we offer choices: either add 4k of a memory directly on the motherboard, or add 16k to 64k of memory by means of a single 5100 card, our famous "JAWS".

Level D kit (CHECK ONE) ... 4k on-board ... \$49.95 plus \$2 P&I*
 16k "JAWS" ... \$149.95 plus \$2 P&I*
 32k "JAWS" ... \$199.95 plus \$2 P&I*
 64k "JAWS" ... \$299.95 plus \$2 P&I*

LEVEL E — An important "building block." It activates the 8k ROM/EPROM space on the motherboard. Now just plug in our 8k Microsoft BASIC or your own custom programs.

Level E kit ... \$5.95 plus 50¢ P&I*
 Microsoft BASIC — It's the language that allows you to talk English to your computer! It is available three ways: 8k cassette version of Microsoft BASIC (requires Level B and 12k of RAM minimum; we suggest a 16k 5100 "JAWS" — see above) ... \$64.95 postpaid.
 8k ROM version of Microsoft BASIC (requires Level B & Level E and 4k RAM; just plug into your Level E sockets. We suggest either the 4k Level D RAM expansion or a 16k 5100 "JAWS" ... \$99.95 plus \$2 P&I*
 Disk version of Microsoft BASIC (requires Level B, 32k of RAM, floppy disk controller, 8" floppy disk drive) ... \$325 postpaid.

TEXT EDITOR/ASSEMBLER — The editor/assembler is a software tool (a program) designed to simplify the task of writing programs. As your programs become longer and more complex, the assembler can save you many hours of programming time. This software includes an editor program that enters the programs you write, makes changes, and saves the programs on cassettes. The assembler performs the clerical task of translating symbolic code into the computer-readable object code. The editor/assembler program is available either in cassette or a ROM version.
 Editor/Assembler (Cassette version; requires Level B and 8k (min) of RAM; we suggest 16k "JAWS" — see above) ... \$59.95 plus \$2 P&I*
 Editor/Assembler (ROM version; supplied on a 5100 card; requires Level B and 4k RAM (min) — we suggest either Level D or 16k "JAWS") ... \$99.95 plus \$2 P&I*

8" FLOPPY DISK — A remarkable "building block." Add our 8" floppy disk when you need faster operation: more convenient program storage, perhaps a business application, and access to the literally thousands of programs and program languages available today. You simply plug them into your Explorer/85 disk system — it accepts all IBM-formatted CP/M programs.
 8" Floppy Disk Drive ... \$499.95 plus \$12 P&I*
 Floppy Controller Card ... \$199.95 plus \$2 P&I*
 Disk Drive Cabinet & Power Supply ... \$69.95 plus \$3 P&I*
 Drive Cables (set up for two drives) ... \$25.00 plus \$1.50 P&I*
 CP/M 2.2 Disk Operating System; includes Text Editor/Assembler, dynamic debugger, and other features that give your Explorer/85 access to thousands of existing CP/M-based programs ... \$150.00 postpaid.

NEED A POWER SUPPLY? Consider our AP-1. It can supply all the power you need for a fully expanded Explorer/85 (note: disk drives have their own power supply). Plus the AP-1 fits neatly into the attractive Explorer steel cabinet (see below).
 AP-1 Power Supply kit (8V @ 5 amps) in deluxe steel cabinet ... \$39.95 plus \$2 P&I*

NEED A TERMINAL? We offer you choices: the least expensive one is our Hex Keypad/Display kit that displays the information on a calculator-type screen. The other choice is our ASCII Keyboard/Computer Terminal kit, that can be used with either



1. Plug in Netronics's Hex Keypad/Display
2. Add Level B to convert to 5100
3. Add 4k RAM
4. Plug in Level E here: accepts Microsoft BASIC or Editor/Assembler in ROM
5. Add two 5100 boards
6. Add your own custom circuitry (prototyping area)
7. Connect terminal

a CRT monitor or a TV set (if you have an RF modulator)

Hex Keypad/Display kit ... \$69.95 plus \$2 P&I*

FASTERM-64 TERMINAL KIT — Featuring a 56 key ASCII Keyboard, 128 character set upper and lower case, 75 ohm output, 8 baud rates: 150 to 19,200 (switch selectable), RS232C or 20 MA output, 32 or 64 character by 16 line terminals, complete with Deluxe Steel Cabinet and Power Supply ... \$199.95 plus \$3 P&I*

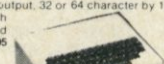

RF Modulator kit (allows you to use your TV set as a monitor) ... \$6.95 postpaid

12" Video Monitor (10MHz bandwidth) ... \$139.95 plus \$5 P&I*

Deluxe Steel Cabinet for the Explorer/85 ... \$49.95 plus \$3 P&I*

Fan for cabinet ... \$15.00 plus \$1.50 P&I*

ORDER A SPECIAL-PRICE EXPLORER/85 PAK — THERE'S ONE FOR EVERY NEED.

Beginner Pak (Save \$26.00) — You get Level A (Terminal Version) with Monitor Source Listing (\$25 value), AP-1, 5-amp power supply, Intel 8085 Users Manual ... (Reg. \$199.95) SPECIAL \$169.95 plus \$4 P&I*

Experimenter Pak (Save \$53.40) — You get Level A (Hex Keypad/Display Version) with Hex Keypad/Display, Intel 8085 User Manual, Level A Hex Monitor Source Listing, and AP-1, 5-amp power supply ... (Reg. \$279.95) SPECIAL \$219.95 plus \$6 P&I*

Special Microsoft BASIC Pak (Save \$103.00) — You get Levels A (Terminal Version), B, D (4k RAM), E, 8k Microsoft BASIC in ROM, Intel 8085 User Manual, Level A Monitor Source Listing, and AP-1, 5-amp power supply ... (Reg. \$439.70) SPECIAL \$329.95 plus \$7 P&I*

Add a ROM-Version Text Editor/Assembler (Requires Levels B and D or 5100 Memory) ... \$99.95 plus \$2 P&I*

Starter 8" Disk System — Includes Level A, B floppy disk controller, one CDC 8" disk-drive, two-drive cable two 5100 connectors; just add your own power supplies, cabinets and hardware ... (Reg. \$1065.00) SPECIAL \$999.95 plus \$13 P&I*
 32k Starter System \$1045.95 plus \$13 P&I*
 48k Starter System \$1095.95 plus \$13 P&I*
 64k Starter System \$1145.95 plus \$13 P&I*

Add to any of above Explorer steel cabinet, AP-1 five amp power supply, Level C with two 5100 connectors, disk drive cabinet and power supply, two sub-D connectors for connecting your printer and terminal ... (Reg. \$225.95) SPECIAL \$199.95 plus \$13 P&I*

Complete 64K System: Wired & Tested ... \$1650.00 plus \$28 P&I*

Specific Complete Business Software Pak (Save \$625.00) — Includes CP/M 2.2 Microsoft BASIC, General Ledger, Accounts Receivable, Accounts Payable, Payroll Package ... (Reg. \$1325) SPECIAL \$699.95 postpaid.

*P&I stands for "postage & insurance." For Canadian orders, double this amount

Continental Credit Card Buyers Outside Connecticut:

TO ORDER
Call Toll Free:
800-243-7428

To Order From Connecticut, or For Technical Assistance, Call (203) 354-9375

CP/M is a reg. trademark of Digital Research

★ (Clip and mail entire ad) ★

SEND ME THE ITEMS CHECKED ABOVE

Total Enclosed (Conn. Residents add sales tax): \$
 Paid by:

Personal Check Cashier's Check/Money Order
 VISA MASTER CARD (Bank No. _____)

Acct. No. _____ Exp. Date _____

Signature _____

Print Name _____

Address _____

City _____

State _____ Zip _____

ANNOUNCING TWO NEW TERMINALS

Smart • Fast • Graphics • Matching Modem and \$295 Printer

Netronics announces a state of the art breakthrough in terminals, now at prices you can afford, you can go on-line with data-bank and computer phone-line services. It's all yours: "electronic newspapers," educational services, Dow-Jones stock reports, games, recipes, personal computing with any level language, program exchanges, electronic bulletin boards ... and more every day!!!

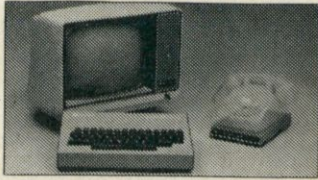

Netronics offers two new terminals, both feature a full 56 key/128 character typewriter-style keyboard, baud rates to 19.2 kilobaud, a rugged steel cabinet and power supply. The simplest one, FASTERM-64, is a 16 line by 64 or 32 character per line unit, with a serial printer port for making hard copy of all incoming data, and optional provisions for block and special character graphics. The "smart" SMARTERM-80, features either 24 line by 80 characters per line or 16 by 40 characters per line, it offers on-screen editing with page-at-a-time printing, 12,000 pixel graphics, line graphics, absolute cursor addressing, underlining, reverse video, one-half intensity and much more ... simply plug them into your computer or our phone modem and be on-line instantly. Use your TV set (RF modulator required) or our deluxe green-phosphor monitor pictured above. For hard copy just add our matched printer.

Price breakthrough!!! Own the FASTERM-64, a complete terminal kit, ready to plug in for just \$199.95 or order the SMARTERM-80 kit for just \$299.95, (both available wired and tested). Be on-line with the million-dollar computers and data services today ... we even supply the necessary subscription forms.

More good news: All the components in our terminals are available separately (see coupon), so you buy only what you need!!!

FASTERM-64 ... DISPLAY FORMAT: 64 or 32 characters/line by 16 lines ... 96 displayable ASCII characters (upper & lower case) ... 8 baud rates: 150, 300, 600, 1200, 2400, 4800, 9600, 19,200 (switch sel.) ... LINE OUTPUT: RS232C or 20 ma current loop ... VIDEO OUTPUT: 1V p/p (EIA RS-170) ... CURSOR MODES: home & clear screen, erase to end of line, erase cursor line, cursor up & down, auto carriage return/line feed at end of line & auto scrolling ... REVERSE VIDEO ... BLINKING CURSOR ... PARITY: off, even or odd ... STOP BITS: 1, 1.5, 2 ... DATA BITS PER CHARACTER: 5, 6, 7 or 8 ... CHARACTER OUTPUT: 5 by 7 dot matrix in a 7 by 12 cell ... PRINTER OUTPUT: prints all incoming data ... 1K ON BOARD RAM ... 2K ON BOARD ROM ... CRYSTAL CONTROLLED ... COMPLETE WITH POWER SUPPLY ... OPTIONAL GRAPHICS MODE: includes 34 Greek & math characters plus 30 special graphics characters ... ASCII ENCODED KEYBOARD: 56 key/128 characters.

SMARTERM-80 ... DISPLAY FORMAT: 80 characters by 24 lines or 40 characters by 16 lines 128 displayable ASCII characters (upper & lower case) 8 baud rates: 110, 300, 600, 1200, 2400, 4800, 9600, 19,200 ... LINE OUTPUT: RS232C or 20 ma current loop ... VIDEO OUTPUT: 1V p/p (EIA RS-170) ... EDITING FEATURES: insert/delete line, insert/delete character, forward/back tab ... LINE OR PAGE TRANSMIT ... PAGE PRINT FUNCTION ... CURSOR POSITIONING: up, down, right, left, plus absolute cursor positioning with read back ... VISUAL ATTRIBUTES: underline, blink, reverse video, half intensity, & blank ... GRAPHICS: 12,000 pixel resolution block plus line graphics ... ON-SCREEN PARITY INDICATOR ... PARITY: off, even or odd ... STOP BITS: 110 baud 2, all others 1 ... CHAR. OUTPUT: 7 by 11 character in a 9 by 12 block ... PRINTER OUTPUT ... 60 OR 50 HZ VERTICAL REFRESH ... BLINKING BLOCK CURSOR ... CRYSTAL CONTROLLED ... 2K ON BOARD RAM ... ASCII ENCODED KEYBOARD: 56 key/128 character ... 4K ON BOARD ROM ... COMPLETE WITH POWER SUPPLY

TELEPHONE MODEM 103 O/A ... FULL DUPLEX, FCC APPROVED ... DATA RATE: 300 baud ... INTERFACE: RS232C and TTY ... CONTROLS: talk/data switch (no need to connect and disconnect phone), originate/answer switch on rear panel ... NO POWER SUPPLY REQUIRED.
ASCII KEYBOARD ASCII-3 ... 56 KEY/128 CHARACTER ASCII ENCODED ... UPPER & LOWER CASE ... FULLY DEBOUNCED ... 2 KEY ROLLOVER ... POS OR NEG LOGIC WITH POS STROBE ... GRAPHICS: 12,000 pixel resolution block plus line graphics ... ON-SCREEN PARITY INDICATOR ... PARITY: off, even or odd ... STOP BITS: 110 baud 2, all others 1 ... CHAR. OUTPUT: 7 by 11 character in a 9 by 12 block ... PRINTER OUTPUT ... 60 OR 50 HZ VERTICAL REFRESH ... BLINKING BLOCK CURSOR ... CRYSTAL CONTROLLED ... 2K ON BOARD RAM ... ASCII ENCODED KEYBOARD: 56 key/128 character ... 4K ON BOARD ROM ... COMPLETE WITH POWER SUPPLY



Continental U.S.A. Credit Card Buyers Outside Connecticut
CALL TOLL FREE 800-243-7428

To Order From Connecticut Or For Tech. Assist. Call (203) 354-9375

NETRONICS R&D LTD. Dept.
333 Litchfield Road, New Milford, CT 06776

Please send the items checked below:

- COMPLETE FASTERM-64 TERMINAL (includes FASTVID-64 video board ASCII-3 keyboard, steel cabinet and power supply) ... kit \$199.95 plus \$3 P&I ... wired & tested \$249.95 plus \$3 P&I ... graphics option: add \$19.95 to each of above
- COMPLETE SMARTERM-80 TERMINAL (includes SMARTVID-80 video board, ASCII-3 keyboard, steel cabinet and power supply) ... kit \$299.95 plus \$3 P&I ... wired and tested \$369.95 plus \$3 P&I
- FASTVID-64 VIDEO BOARD (requires +5 & -12V DC) ... kit \$99.95 plus \$3 P&I ... graphics option add \$19.95 ... wired & tested \$129.95 plus \$3 P&I ... graphics option add \$19.95
- SMARTVID-80 VIDEO BOARD (requires +5 & +/-12V DC) ... kit \$199.95 plus \$3 P&I ... wired & tested \$249.95 plus \$3 P&I
- DELUXE STEEL TERMINAL CABINET ... \$19.95 plus \$3 P&I
- ASCII-3 KEYBOARD (requires +5 & -12VDC) ... kit \$69.95 plus \$3 P&I ... wired and tested \$89.95 plus \$3 P&I
- POWER SUPPLY (powers ASCII-3 keyboard & video boards) ... kit only \$19.95 plus \$2 P&I
- ZENITH VIDEO MONITOR (high resolution green phosphor) ... wired & tested \$149.95 plus \$6 P&I
- TELEPHONE MODEM MODEL 103 O/A ... wired & tested \$189.95 plus \$3 P&I
- DOT MATRIX PRINTER Comet I ... wired & tested \$299.95 plus \$10 P&I
- RF MODULATOR MOD RF-1 ... kit only \$8.95 plus \$1 P&I
- 3FT-25 LEAD MODEM/TERMINAL OR PRINTER/TERMINAL CONNECTOR CABLE ... \$14.95 ea plus \$2 P&I

For Canadian orders, double the postage. Conn. res. add sales tax.

Total Enclosed \$ _____

Personal Check Cashier's Check/Money Order
 VISA MasterCard (Bank No. _____)
 Acct. No. _____ Exp. Date _____

Signature _____

Print Name _____

Address _____

City _____ State _____ Zip _____

NETRONICS Research & Development Ltd.
333 Litchfield Road, New Milford, CT 06776

PRIORITY ONE ELECTRONICS

1
ONE

☆☆☆ **CompuPro™** ☆☆☆

5 REASONS WHY YOU SHOULD SPEND AN EXTRA 5¢ WITH PRIORITY ONE

Some of you may have noticed that some other vendors have started to advertise CompuPro products. Frankly, we're amused that it has taken them this long to see that you want state-of-the-art IEEE/696 S-100 products. The discriminating user wants boards that meet the IEEE standard, not just any board with 100 pins that is obsolete before it is sold. We've known this for years, that is why we have continued to grow while others have had to cut back. To attract your business, they try to copy us and cut the price, often by as little as five cents. Rather than cut price, we offer the best combination of price, performance, and support in the business. We at Priority One are proud of what we offer for that extra five cents. Priority One Electronics is more than just a computer store or mail order house — we're an Authorized CompuPro Systems Center. Priority One is the first place you should turn to for business, scientific, and industrial computing solutions. Here are just five examples of what that extra five cents buys:

- As an Authorized Systems Center, we provide custom system integration from board level components
- We maintain full documentation on all CompuPro hardware and software
- We attend and hold periodic factory training seminars on CompuPro products
- We have factory trained Sales Engineers available to answer your questions after the sale is made. When you call Priority One, you'll speak with a professional, not an answering machine or answering service
- We buy directly from the factory, not from two step distributors, so we're always first to receive new products and new information about enhancements for existing products. When we buy direct, we we buy in volume. Whether you need one board or one hundred, we can usually deliver from stock

When you're ready for professional level, state-of-the-art micro-computing, turn to Priority One, the world's largest Authorized CompuPro Systems Center. We're ready for you.

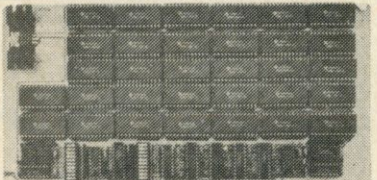

CMOS STATIC RAM

For a complete analysis of the advantages of CMOS memory, see the "Product Description" on page 416 of the January Issue of BYTE

RAM 17 - 64K CMOS STATIC RAM

RAM 17, 10 MHz, 2 Watt, DMA Compatible 24 Bit Addressing

Part No.	Description	List Price	Our Price
KIGBT175A64	64K A&T	\$599.00	\$550.00
KIGBT175C64	64K CSC	\$750.00	\$699.00

RAM 16 - 32K x 16 BIT CMOS STATIC RAM

RAM 16 10 MHz, 32K x 16 or 64K x 8 IEEE/696 16 Bit 2 Watt, 24 Bit Addressing

KIGBT180A	64K A&T	\$650.00	\$599.00
KIGBT180C	64K CSC	\$750.00	\$699.00

NEW! RAM 21 - 128K STATIC RAM

RAM 21 12MHz, 128K x 8 or 64K x 16 "WOW!" IEEE/696 8 or 16 Bit 1.2 Amps, 24 Bit Addressing

KIGBT190A	128K A&T	\$1695.00	\$995.00
KIGBT190C	128K CSC	\$1895.00	\$1795.00

STATIC MEMORY BOARDS

RAM 20 - 32K STATIC RAM

RAM 20 10 MHz, 4K byte block disable, bank select or 24 bit addressing available 8, 16, 24 or 32K

KIGBT164A8	8K A&T	\$210.00	\$190.00
KIGBT164A8	8K CSC	\$280.00	\$260.00
KIGBT164A16	16K A&T	\$285.00	\$260.00
KIGBT164A16	16K CSC	\$355.00	\$325.00
KIGBT164A24	24K A&T	\$355.00	\$325.00
KIGBT164A24	24K CSC	\$425.00	\$385.00
KIGBT164A32	32K A&T	\$425.00	\$385.00
KIGBT164A32	32K CSC	\$495.00	\$450.00



S-100 MAINFRAME

110V 60Hz CVT Mainframe uses famous 20 slot COMPUPRO Motherboard. 55 lbs.

KIGBTENC20RM	20 Slot Rack Mount	\$895.00	\$825.00
KIGBTENC20DK	20 Slot Desk Top	\$825.00	\$760.00

CompuPro™

NEW! CPU BOARDS
CO-PROCESSOR 8086/8087 (816)
16 bit 8 or 10 MHz 8086 CPU with sockets for 8087 and 80130

Part No.	Description	List Price	Our Price
KIGBT186A	A&T 8MHz 8086 only	\$695.00	\$ 625.00
KIGBT186C	CSC 10MHz 8086 only	\$850.00	\$765.00
KIGBT186A87	A&T with 8087 option*	\$1295.00	\$1225.00
KIGBT186C87	CSC with 8087 option*	\$1550.00	\$1456.00

*8087 Limits clock speed to 5MHz

DUAL PROCESSOR 8085-8088

6 or 8 MHz Provides true 16 Bit Power with a standard 8 bit S-100 bus

KIGBT1612A	A&T 6MHz	\$425.00	\$399.00
KIGBT1612C	CSC 6/8 MHz	\$525.00	\$498.00

CPU-Z Z80 CPU

2/4 MHz Z80 CPU 24 Bit Addressing

KIGBT190A	A&T	\$295.00	\$280.00
KIGBT190C	CSC 3-6 MHz	\$395.00	\$375.00

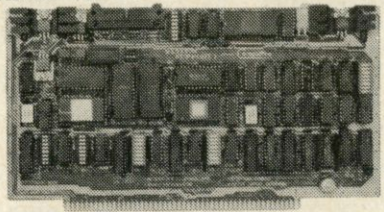

I/O BOARDS

SYSTEM SUPPORT 1 MULTIFUNCTION BOARD
Serial port (software prog. baud), 4K EPROM or RAM provision, 15 levels of interrupt, real time clock, optional math processor

Part No.	Description	List Price	Our Price
KIGBT162A	Assembled & Tested	\$399.00	\$360.00
KIGBT162C	CSC	\$495.00	\$460.00
KIGBT8231	Math Chip		\$195.00
KIGBT8232	Math Chip		\$195.00
KIGBT162AM1	A&T with 8231 Math Chip		\$555.00
KIGBT162CM1	CSC w/8231 Math Chip		\$655.00
KIGBT162AM2	A&T w/8232 Math Chip		\$555.00
KIGBT162CM2	CSC w/8232 Math Chip		\$655.00

MPX CHANNEL BOARD

I/O Multiplexer, using 8085A-2 CPU on board with 4K RAM

KIGBT166A4	Assembled & Tested	\$495.00	\$445.00
KIGBT166C4	CSC	\$595.00	\$535.00

With 16K RAM

KIGBT166A16	Assembled & Tested	\$649.00	\$585.00
KIGBT166C16	CSC	\$749.00	\$675.00

INTERFACER 1

Two Serial I/O

KIGBT133A	Assembled & Tested	\$249.00	\$219.00
KIGBT133C	CSC	\$324.00	\$298.00

INTERFACER 2

Three parallel, one serial I/O board

KIGBT150A	Assembled & Tested	\$249.00	\$219.00
KIGBT150C	CSC	\$324.00	\$299.00

INTERFACER 3

Eight channel multi-use serial I/O board

KIGBT174A	Assembled & Tested	\$699.00	\$629.00
KIGBT174C	CSC 200 hr. 8 Port	\$849.00	\$750.00
KIGBT174A	Assembled & Tested	\$599.00	\$559.00
KIGBT174C	CSC 200hr. 5 port	\$699.00	\$629.00

NEW!

INTERFACER 4

Three Serial, 1 Parallel, 1 Centronics Parallel

KIGBT187A	Assembled & Tested	\$350.00	\$315.00
KIGBT187C	CSC	\$450.00	\$415.00

SPECTRUM COLOR GRAPHICS

Color Graphics board with Parallel I/O

KIGBT144A	Assembled & Tested	\$399.00	\$349.00
KIGBT144C	CSC	\$449.00	\$339.00
KIGBT20	Sublogic Universal Graphics Interpreter Software		\$35.00

S-100 MOTHERBOARDS

Active termination, 6-12-20 Slot

KIGBT153A	A&T 6 slot, 2 lbs.	\$140.00	\$126.00
KIGBT153C	CSC 6 slot, 2 lbs.	\$190.00	\$175.00
KIGBT154A	A&T 12 slot, 3 lbs.	\$175.00	\$155.00
KIGBT154C	CSC 12 slot, 3 lbs.	\$240.00	\$220.00
KIGBT155A	A&T 20 slot, 4 lbs.	\$265.00	\$235.00
KIGBT155C	CSC 20 slot, 4 lbs.	\$340.00	\$310.00

ACTIVE TERMINATOR

Allows older S-100 motherboards to run faster and quieter

KIGBT106A	Assembled & Tested	\$59.50	
-----------	--------------------	---------	--

CompuPro

FREE CP/M 2.2

DISK CONTROLLERS

DISK 1 FLOPPY CONTROLLER

Fast DMA, Soft Sector, Controls 8" or 5 1/4" Single or Double Density. OUR BEST!

KIPDBT171ACP	A&T w/CP/M2.2 & BIOS\$670.00	\$450.00
KIGBT171C	CSC \$595.00	\$555.00
KIGBTCPM80*	CP/M 2.2 for Z80/8085 with manuals & BIOS 8" S/D disk	\$175.00
KIGBTCPM86	CP/M for 8086 with manuals & BIOS 8" S/D disk	\$300.00

NEW! DISK 2/SELECTOR CHANNEL HARD DISK CONTROLLER

Fast DMA 2 board set Controls 4 Shugart 4000 series or Fujitsu 2300 type drives. Includes CP/M 2.2*

KIGBT177A	Assembled & Tested	\$795.00
KIGBT177C	CSC	\$895.00



SPECIAL PURCHASE

California Computer Systems **2065 64K S-100 Dynamic RAM**

- IEEE S-100 compatible • 2 or 4MHz • Supports lmsai-type front panels • Processor transparent refresh with both Z80 and 8080 systems • Jumper selectable Phantom input • All ICs in sockets • Any 16K block can be made bank independent • Fully buffered address and data lines • Board configuration with reliable Berg Jumpers • Full Factory Warranty

KICCS20653 LIST PRICE: \$350.00
SALE \$249.00 Each - or 4 for \$880.00!!

5" DISKETTES!

SOFT SECTOR

40 TRACK SINGLE SIDED DOUBLE DENSITY WITH HUB REINFORCING RINGS

PKG. OF 10 \$19.95

BONUS!

FREE! CASSETTE 10 LIBRARY CASE WITH PACKAGE OF 10 DISKETTES

A \$4.25 VALUE Part No. BHPRI5DD

KIPRI580	package of 80 less Library Case	\$120.00
KIPRI8SD	package of 10 8" S.S./D.D. Diskettes no sleeves 5 or more packages	\$20.00
		\$18.00



FCC CLASS 2 APPROVED DATA DISPLAY MONITORS



SPECIFICATIONS:

Viewing Screen	12" diagonal; 75 square inches
Scanning System	DM2112: P31 phosphor
Horizontal Resolution	525 lines; 60 fields/second; overscan 600 lines, center
Signal Input	1.0 volt p-p composite video; 75 ohms

BHSYODM2112

List Price: \$160.00 **SALE: \$119.00**
OTHER SANYO MONITORS ON SALE TOO!!

Part No.	Description	List Price	SALE
KI STOVN4509	9" B&W P4, 10MHz (15 lbs)	\$215.00	\$149.00
KI STODM4509CX	9" Green, P31, 10MHz (15 lbs)	\$200.00	\$159.00
KI STODM8012C	12" B&W P4, 18MHz (24 lbs)	\$250.00	\$195.00
KI STODM812CS	12" Green, P31, 18MHz (24 lbs)	\$260.00	\$199.00
KI STOVN60013	13" Color, 16 x 64 (35 lbs)	\$470.00	\$375.00
KI STODM6113*	13" RGB Color (35 lbs)	\$995.00	\$895.00

*As used with IBM P.C.

PRIORITY ONE ELECTRONICS

FUJITSU FROM SELSUM LETTER QUALITY PRINTERS

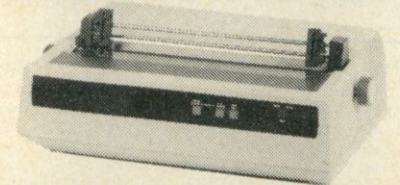

Speed and Unmatched Performance

Interfaces: • RS232C and Current Loop • Centronics type parallel interface • IEEE488 All are DIP switch selectable.
Personality Protocols: • NEC5510 • DIABLO 630 • QUME Sprint 9 • IBM Personal Computer • ATARI (Centronics 737).
Special Features: • 280 CPU • 12K ROM • Standard 16K Buffer • Optional 48K Buffer • 50 - 19.2K baud • Micro-coded alarm differentiates error conditions with pulse combinations • Intelligent bi-directional printing with logic seeking • Complete word processing features • Self test • Auto reprint • Auto clear error • Proportional spacing • Supports Automatic justification • Complete Vector plotting routines • Sheet feeder mode allows easy interface to most mechanical sheet feeders • 6 month warranty • Quiet - 50db • Front panel forms control • Universal power supply 115/220V 50/60 Hz.

BEST BUY! 80 Characters per Second! WOW! LETTER QUALITY! USING THE FUJITSU SP830

Part No.	Description	List Price	Our Price
KI SLMF86	Intelligent Printer	\$3495.00	\$2795.00
OPTIONS			
KI SLMF86VFT	Vertical forms tractor		\$200.00
KI SLMF8648K*	48K RAM buffer		\$300.00
<i>Call for pricing on sheet feed options *Must be ordered with the printer</i>			
INTERFACE CABLES			
KI CPAM572	Centronics IBM/NEC Cable		\$80.00
KI SCDB251	RS232C Serial Cable		\$60.00
<i>Call for other cables not listed</i>			

SMITH-CORONA TP-1 LETTER QUALITY - ELECTRONIC TEXT PRINTER

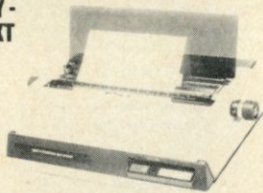

\$649.00
KISCMTPS10

- 12 CPS • 10 CPI • 6LPI • SERIAL INTERFACE
 - 50-19.2K Baud • Friction Feed • 88 Character
- | | | | |
|-------------|-----|---------------------|--------|
| KI SCM12625 | TP1 | Black Milar Ribbon | \$3.50 |
| KI SCM12658 | TP1 | Black Fabric Ribbon | \$7.50 |

APPLE DISK DRIVES

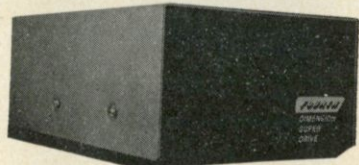

Give your APPLE II® a Fourth Dimension — the totally compatible 5 1/4" drive that takes your system farther, faster. With read/write electronics so advanced that reading errors are virtually eliminated. With a track zero microswitch that keeps boot and track access smooth and quiet. With the ability to read half-track software and up to 143,360 bytes on DOS 3.3®. With similar performance on DOS 3.2.1®, Pascal® or CP/M® operating systems. And, the disk enclosure mates perfectly with APPLE cabinetry.

EXTENDED WARRANTY

Fourth Dimension offers a 12 month parts and labor warranty at no cost to you! (Gee, this really looks good!)

KI FDS40A	List Price: \$419.00	SALE: \$369.00
2 or More, only \$350.00 each		
KI FDS40AC*	APPLE II® Disk Drive Controller	\$115.00

Hayes

KI DCH0200P	Smartmodem (Sh. Wt. 6 lbs.)	\$279.00	\$225.00
KI DCH0300P	Chronograph (Sh. Wt. 3 lbs.)	\$249.00	\$205.00
KI DCH0100P	Chronograph 100 (Sh. Wt. 4 lbs.)	\$399.00	\$325.00
KI DCH2901D	CP/M® 8" Terminal Program for above	\$25.00	\$25.00
KI DCH0000P	Micromodem II	\$379.00	\$299.00
KI DCH2401D	Datacom (PASCAL patch) for above	\$50.00	\$50.00

FREE TRACTOR AND FREE OKIGRAPH!! OKIDATA

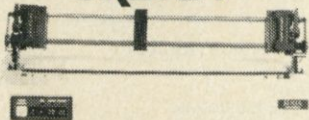

COMPARE OKIDATA'S FEATURES TO ANY OTHER PRINTER! COMPARE PRIORITY ONE'S PRICES TO ANY — THEN DECIDE!

Don't be fooled by those who try to "soak" you for the options

- BI-DIRECTIONAL-120 CPS • Both Parallel and 1200
- 9 x 9 Matrix (Alphanumeric) baud Serial I/O (82A & 83A)
- 6x9or12 Matrix for graphics • Self Test
- 5,8,3, 10, 16 Characters • Out of Paper Switch
- Per Inch • Friction or Optional Tractor
- 80 CPL @ 10 CPI for 82A Feed (Tractor Standard on 84)
- 132 CPL @ 100CPI for • 10 different character sets 83A & 84

All three printers feature front panel switch selectable for lengths: 10 lengths from 3" to 14". Front or bottom aper loading for up to 4 part forms and tear bar. All of these features make OKIDATA the best value in low cost printers!

Part No.	Description	List Price	SALE
KI PDB0K182ATG	OKIDAT82A w/tractor and graphics	\$539.00	
KI PDB0K183ATG	OKIDAT83A w/tractor & graphics	\$750.00	
KI OKISER2KBF	9600 Baud 2K serial buffer/interface	\$149.00	
KI OKIDAT84AP	132 col. printer parallel interface with graphics and tractor (35 lbs.)	\$1095.00	
KI OKIDAT84AS	132 col. printer 9600 baud serial 2K interface, graphics and tractor (35 lbs.)	\$1250.00	
KIMBSAPLWTC*	Apple Parallel Interface w/Cable	\$75.00	

*Sold only with printer

COMPARE PRICES!!

ADDS

Applied Digital Data Systems Inc.

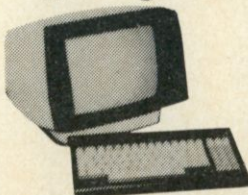

SALE!
Green Screen
\$525.00
Black & White
\$479.00

VIEWPOINT — ADDS

Detachable keyboard, RS232 interface and auxiliary port, 80 x 24 display, tiltable screen.

KIADDVWPR	ADDS 3A, P31 Green Phosphor	\$699.00	\$525.00
<i>(Shipping Weight 30 lbs.)</i>			

TeleVideo

WORLD'S BEST SELLING TERMINAL!

Extra Memory Pages!

FREE!!

- KI PDBTLV9252P* \$749.00
*TeleVideo 925 w/free 2nd page memory kit, a \$95.00 value!
- KI PDBTLV9504P* \$949.00
*TeleVideo 950 w/free 2nd, 3rd & 4th page memory kit, \$285.00 value
- KI TLV910 Sh. Wt. 43 lbs. \$599.00

BEST BUY!

**SEND \$1.00 TODAY
FOR THE NEW, FULL COLOR
SPRING 1982 ENGINEERING
SELECTION GUIDE!**



PRIORITY ONE ELECTRONICS
9161 DEERING AVE • CHATSWORTH, CA 91311
ORDER TOLL FREE (800) 423-5922 - CA, AK, HI CALL (213) 709-5464

Terms: U.S. VISA, MC, BAC, Check, Money Order, U.S. Funds Only CA residents add 6 1/2% Sales Tax. MINIMUM PREPAID ORDER \$15.00. Include MINIMUM SHIPPING & HANDLING of \$3.00 for the first 3 lbs., plus 40¢ for each additional pound. Orders over 50 lbs. sent freight collect. Just in case, please include your phone number. Prices subject to change without notice. We will do our best to maintain prices through September, 1982. Credit Card orders will be charged appropriate freight. If you haven't received your Spring '82 Engineering Selection Guide, send \$1.00 for your copy today! Sale prices are for prepaid orders only.

Tandon

Tandon TM-800 Thinline is exactly half the size of conventional 8" floppy disk drives.

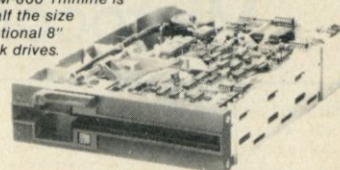

**1
ONE**

Exactly one-half the height of any other model. Proprietary, high-resolution, read-write heads patented by Tandon. D.C. only operation - no A.C. required. Industry standard interface.

Three millisecond track-to-track access time (9 lbs.)
KITNDTM8481 Single Sided \$380.00 2 or more \$370.00
KITNDTM8482 Double Sided \$495.00 2 or more \$485.00
KITNDTM88M Manual - not included with drive \$10.00

TANDON 5 1/4" DRIVES

KITNDTM1001	Single Sided, 250KB (5 lbs.)	\$220.00 * ea
2 or More \$200.00		
KITNDTM1002	Double Sided, 500KB	\$295.00 ea.
2 or More \$270.00		
KITNDTM1003	Single Sided, 500KB	\$295.00 ea.
2 or More \$270.00		
KITNDTM1004	Double Sided, 1000KB	\$395.00 ea.
2 or More \$375.00		
KITNDTM5M	manual, not included with drive	\$10.00

*As used in the IBM P.C.

MITSUBISHI ELECTRIC

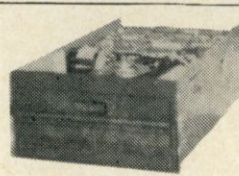

**Better Than
QUME!
Better Than
SHUGART!**

8", Double-sided, double-density, interchangeable with QUME & Shugart
KI MITM289463 Sh. Weight 16 lbs. \$495.00
KI MITM289463 M Manual \$10.00
2 or More \$475.00 each

Shugart 801R

Single sided, double density - most popular 8" drive
KI SHU801R \$394.90 ea. or 2 or more (16 lbs) for \$369.90
KI SHUSA801RM Manual for 801R drives \$10.00



INTERNATIONAL INSTRUMENTATION, INC.

OUR BEST!!

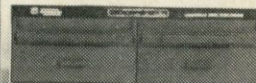

UNIVERSAL DISK ENCLOSURES

- Accepts any combination of 8" drives (QUME/Shugart 801R type or 1/2 size Tandon type) • Also accepts hard disks • Positive pressure • Optional Disk environment monitor shows supply voltage and internal cabinet temperature • Internal power and data cables provided.
- UNIVERSAL DRIVE CABINET** complete with power supply, fan and filter, and all internal cables for attachment of two 8" floppy drives.
- | | | | |
|----------------|--|----------|----------|
| KI IIUDE004 | Dual Drive Cabinet (Sh. Wt. 40 lbs) | \$495.00 | \$450.00 |
| KI IIUDE004 | With purchase of two 8" Disk Drives | | \$399.00 |
| KI IIUDE004EM | w/Environmental Monitor installed | \$584.95 | \$535.00 |
| KI IIUDE004EM | With purchase of two 8" Disk Drives | | \$485.00 |
| KI IIUDE004AUG | Dual Drive cabinet with Aug-mentation power supply module to increase 5V supply from 6 amps to 9 amps for use with two hard disks or 4 Tandon drives. Also includes Disk Environment Monitor (45 lbs.) | \$733.00 | \$650.00 |
| KI IIUDE004 | 19" Rack Mount kit UDE004 | | \$89.95 |

THIN THREE DRIVE CABINET complete with power supply, and all internal cables for attachment of three thin 8" floppy drives (Tandon type). One AC power connector is also provided for use with full size drive.

KI IIUDET7	Three Drive Cabinet (Sh. Wt. 35 lbs)	\$495.00	\$450.00
KI IIUDET7EM	with Environmental Monitor installed	\$584.95	\$535.00

Microcomputing® ● List of Advertisers

Reader Service Number	Page	Reader Service Number	Page	Reader Service Number	Page
273	A B M Products	57	60	Eastern House Software	107
465	ATV Research	144	82	Ecosoft	108
91	Aardvark-80	27	169	Elcomp Publishing, Inc.	37
409	Abacus Software	24	25	Electronics Center	27
311	Ackerman Digital Systems Inc.	34	93	Electronic Specialists, Inc.	141
494	Advanced Operating Systems	150	*	Encyclopedia for the TRS-80	149
249	Alien Group, The	109	422	Epic Computer Corp.	30, 149
369	Amdek Corporation	4	493	Epyx	150
464	Amdek Corporation	146	78	Expotek	77
187	Ancie Labs	137	70	Faxscan, Inc.	87
393	Andra Tech	46	206	Fort Worth Computers	68
166	Answer in Computers, Inc.	69	489	Generic Software	151
413	Apple Books, Inc.	28	22	Gimix, Inc.	139
484	Apple Computer, Inc.	148	104	Gosub International, Inc.	151
401	Arrow Micro Software	24	487	HTL Telemanagement, Ltd.	148
402	Arrow Micro Software	28	177	H-Scoop	44
319	Artcom Data Services	94	6	H & E Computronics	63
435	Atari, Inc.	96	10	Happy Computer, The	94
220	Austin Computer Technology	31	243	Happy Hands	81
87	B&B Electronics	78	419	Hartley Courseware, Inc.	28
*	B.G. Micro	114	279	IDPC Company	79
*	Back Issues	78	447	Infocom	99
168	Basic Books, Inc.	41	433	Innovative Design Software, Inc.	96
490	Barron Enterprises	151	128	Innovative Technology	107
131	Bay Technical Associates	53	412	Insoft	26
417	Behavioral Engineering	26	428	Insoft	28
326	Bourbon Street Press	99	*	Instant Software, Inc.	153, 154
444	Broderbund Software, Inc.	97	77	Integrand Research Corp.	40
*	Burtonix	146	481	Intellimac, Inc.	143
79	C&S Electronics Mart, Ltd.	47	84	JDR Microdevices, Inc.	116-119
346	C.S.C.S.	47	180	J.E.S. Graphics	69
148	CDR Systems, Inc.	31	92	JPC Products Company	136
283	CGRS Microtech	41	284	JRT Systems	45
271	CP.M Company	78	48	Jade Computer Products	111-113
256	CPU Shop, The	122	41	Jameco Electronics	124, 125
466	Cardco, Inc.	146	295	Jim Quinn Computer Division	7
437	Cavalier Computer	97	164	Jimsco, Inc.	29
86	Check-Mate	107	*	John Bell Engineering, Inc.	43
80	Check-Mate	31	483	John Wiley & Sons, Inc.	148
332	Check-Mate	78	397	Journal of Pascal & Ada	61
228	Chicago FM Club	44	54	Key Software	27
170	Chips & Dale	79	472	Kraft Systems, Inc.	142
105	Colonial Data	60	198	LNW Research	56
133	Colonial Data	86	355	Leading Edge Products, Inc.	CIV
467	Commodore Business Machines, Inc.	138	482	Learning Company, The	150
90	CompuCover	47	78	Lifeboat Associates	69
468	CompuPro Systems	146	411	Lifetree Software, Inc.	30
371	CompuServe	9	427	Link Systems	30
204	CompuShack	23	373	Logical Devices, Inc.	57
49	Compview	91	316	MJF Enterprises, Inc.	31
320	Computer Case Company	65	234	Magnolia Microsystems	87
18	Computer Design Labs	33	95	Manx Software Systems	7
404	Computer Development, Inc.	30	72	Master Electronics, Inc.	21
120	Computer Discount of America	87	165	Med Systems Software	149
110	Computer Peripherals Unlimited	141	308	Micro 80, Inc.	61
362	Computer Plus	79	216	Microflash Company	47
36	Computer Shopper	65	309	Micro-Grip, Ltd.	69
469	Computer System Associates	140	*	Micro Ink, Inc.	17
227	Computers Wholesale	22	*	Micro Instructional, Inc.	3
297	Concord Computer Products	115	443	Micro Lab	97
426	Continental Software	28	381	Micro Match	21
292	Coosol, Inc.	159	407	Microphys	28
197	Cornucopia Software	149	68	Micro Resources Corp.	108
485	Creative Educational Service	148	420	Micro-Sparc, Inc.	25
406	Creature Computing Software	24	432	Microsoft Consumer Products	
400	Cross Educational Software	30	*	Micro Technical Products	145
252	Cuesta Systems	47	*	Microcomputing Binders	160
356	Curtis Manufacturing Co.	53	*	Microcomputing Books	131-133
63	D/Punch Company	160	*	Microcomputing Dealers	151
293	D & N Micro Products	85	*	Microcomputing Moving	141
35	Daman	31	*	Microcomputing Sales	159
414	Datamost	26	*	Microcomputing Shelf Boxes	145
446	Datamost	96	*	Microcomputing Subscriptions	35, 107
431	Datasoft	99	144	Midwest Scientific Instruments	18, 19
449	Data Soft, Inc.	30	255	Miller Microcomputer Services	156
423	Data Transform Inc.	24	238	Mini Micro Mart	92, 101
416	Digital Constructs	26	*	NEC	17
471	Digital Equipment Corp.	138	473	NEC Information Systems, Inc.	140
*	Digital Research Computers	120	*	NRI Schools	25
250	Discount Software Group	157	*	Nanos Systems	81
425	Donald Poling	26	*	National Computer Shows	13
480	Dynabyte Business Computers	143	*	*This advertiser prefers to be contacted directly.	
*	Netronics R&D, Ltd.	93, 127			
286	Nibble	55			
415	Nikon Technical Products	25			
492	Omega MicroWare, Inc.	150			
140	Omnitek Computers International, Inc.	29			
434	On-Line Systems	99			
204	P.D.S., Inc.	23			
172	Pacific Exchanges	28, 46, 78, 107			
*	Percom Data Company, Inc.	CII			
19	Peripherals Unlimited	105			
266	Perry Oil & Gas, Inc.	65			
370	Personal Computer Age	161			
303	Personal Computer Systems	87			
103	Pion, Inc.	151			
146	Pocket Computer Newsletter	21			
277	Priority One	128, 129			
233	Protecto Enterprises	87			
305	Protecto Enterprises	160			
137	Quasar Electronics	73			
44	Quest Electronics	123			
495	RAK Electronics	148			
390	R.W. Electronics	14			
74	R.W. Electronics	15			
101	Racet Computes, Ltd.	141			
61	Radix Technologies	143			
188	Rainbow P & P Company	136			
102	Rand's, Inc.	47			
71	Realty Software Company	79			
132	68 Micro Journal	46			
421	S & H Software	24			
111	S. Z. Software Systems	87			
117	Saturn Systems	76			
386	Scientific Software	46			
205	Selectronics	126			
375	Semi Disk Systems	67			
162	Seneca Electronics	146			
359	Simpliway Products Company	107			
*	Sinclair Research Company	82, 83			
436	Sirius Software, Inc.	96			
438	Sirius Software, Inc.	96			
442	Sirius Software, Inc.	97			
445	Sirius Software, Inc.	99			
448	Sirtech	96			
496	SmithRick Associates	150			
*	Snappware, Inc.	90			
486	Softrend, Inc.	148			
488	Software Arts, Inc.	148			
302	Software Connection, The	45			
491	Software Publishing Corp.	150			
294	Software Support	98			
213	Sonic Microsystems	11			
430	Southern Computer Systems, Inc.	26			
408	Southwest EdPsych Services, Inc.	30			
361	Star Micronics, Inc.	48, 49			
237	States Computers	142			
179	Stellation Two	89			
181	Supersoft, Inc.	150			
474	Synetix Industries, Inc.	144			
475	Szyzzy	144			
318	TNW Corp.	53			
189	Tab Sales Company	7			
139	Tech Data Corporation	31			
241	Telcon Industries	147			
476	Texas Instruments, Inc.	142			
118	Three G Company, Inc.	57			
477	Toshiba America, Inc.	140			
399	Unified Software Systems	66			
478	Vector Graphic, Inc.	144			
285	Vespa Computer Outlets	107			
158	Vynet Corporation	47			
403	WIMS Computer Consulting	24			
405	WIMS Computer Consulting	30			
*	Wameco/Mikos, Inc.	121			
*	Wayne Green Books	95			
*	Wayne Green International	72			
*	Weather Satellite	145			
45	Winchendon Group, The	29			
163	Wintek Corporation	78			
*	World Wide Media	87			
122	WSR Software Associates	31			
479	Zenith Data Systems	140			

For further information from our advertisers, please use the Reader Service card.

Special Interests

MICROCOMPUTING BOOKS

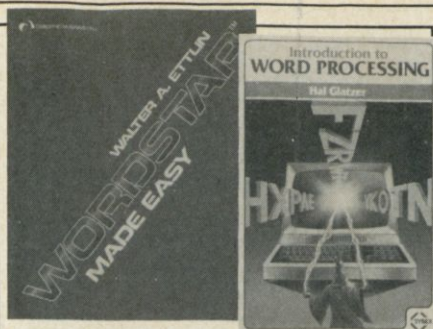

A USER GUIDE TO THE UNIX SYSTEM by Jean Yates and Rebecca Thomas. Here at last is a clearly written book that allows you to use the Unix operating system easily, and at a fraction of the time it previously took. If you're using, evaluating or simply curious about this system, this is your book. BK1242 \$15.99

WORDSTAR MADE EASY by Walter A. Ettlin. Now WordStar is as simple to learn as it is easy to use. This book teaches WordStar in 14 easy lessons, saving hours of hard work. It comes with a convenient pull-out Command Card. BK1239 \$7.95

INTRODUCTION TO WORD PROCESSING by Hal Glatzer. This book explains in plain language what a word processor can do, how to use one, how it improves productivity—especially in businesses that handle lots of words—and how to buy one wisely. No technical knowledge required, for all first-time users and those considering purchasing a word processor. BK1238 \$12.95

THE CUSTOM TRS-80 AND OTHER MYSTERIES—by Dennis Kitsz. More than 300 pages of TRS-80 customizing information. With this book you'll be able to explore your computer like never before. Want to turn an 8 track into a mass storage unit? Individual reverse characters? Replace the BASIC ROMs? Make Music? High speed, reverse video, Level I and Level II? Fix it if it breaks down? All this and much, much more. Even if you have never used a soldering iron or read a circuit diagram, this book will teach you how! This is the definitive guide to customizing your 80! BK1218 \$29.95.*

BASIC FASTER AND BETTER AND OTHER MYSTERIES—by Lewis Rosenfelder. You don't have to learn assembly language to make your programs run fast. With the dozens of programming tricks and techniques in this book you can sort at high speed, swap screens in the twinkling of an eye, write INKEY routines that people think are in assembly language and add your own commands to BASIC. Find out how to write elegant code that makes your BASIC really hum, and explore the power of USR calls. BK1221 \$29.95.*

THE CP/M HANDBOOK (with MP/M)—by Rodney Zaks. A complete guide and reference handbook for CP/M—the industry standard in operating systems. Step-by-step instruction for everything from turning on the system and inserting the diskette to correct user discipline and remedial action for problem situations. This also includes a complete discussion of all versions of CP/M up to and including 2.2, MP/M and CDOS. BK1187 \$14.95.*

TRS-80 DISK AND OTHER MYSTERIES—by Harvard C. Pennington. This is the definitive work on the TRS-80 disk system. It is full of detailed "How to use," information with examples, samples and in-depth explanations suitable for beginners and professionals alike. The recovery of one lost file is worth the price alone. BK1181 \$22.50.*

MICROSOFT BASIC DECODED AND OTHER MYSTERIES—by James Farvour. From the company that brought you TRS-80 DISK AND OTHER MYSTERIES. Contains more than 6500 lines of comments for the disassembled Level II ROMs and six additional chapters describing every BASIC subroutine, with assembly language routines showing how to use them. Flowcharts for all major routines give the reader a real insight into how the interpreter works. BK1186 \$29.50.*

NEW NEW

Introductory

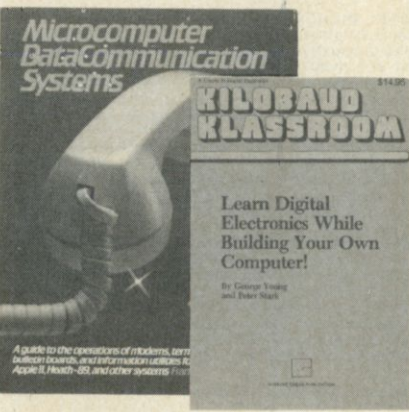

KILOBAUD CLASSROOM—by George Young and Peter Stark. Learning electronics theory without practice isn't easy. And it's no fun to build an electronics project that you can't use. *Kilobaud Classroom* the popular series first published in *Kilobaud Microcomputing*, combines theory with practice. This is a practical course in digital electronics. It starts out with very simple electronics projects, and by the end of the course you'll construct your own working microcomputer!

Authors Young and Stark are experienced teachers, and their approach is simple and direct. Whether you're learning at home or in the classroom, this book provides you with a solid background in electronics—and you'll own a computer that you built yourself! BK7386 \$14.95

TOOLS & TECHNIQUES FOR ELECTRONICS—by A. A. Wicks is an easy-to-understand book written for the beginning kit-builder as well as the experienced hobbyist. It has numerous pictures and descriptions of the safe and correct ways to use basic and specialized tools for electronic projects, as well as specialized metal-working tools and the chemical aids which are used in repair shops. BK7348 \$4.95.*

MICROCOMPUTER DATA COMMUNICATIONS SYSTEMS by Frank J. Derrler. This text has a lot of good information on message systems and information utilities; the fundamentals of data communications, modems, terminals, and software for specific microcomputers. Interesting and informative for the beginner, yet a good reference for the experienced data communications user. BK1243 \$12.95

UNDERSTANDING AND PROGRAMMING MICROCOMPUTERS—A valuable addition to your computing library. This two part text includes the best articles that have appeared in 73 and Kilobaud Microcomputing magazines on the hardware and software aspects of microcomputing. Well known authors and well structured text helps the reader get involved. BK7382 \$10.95.*

SOME OF THE BEST FROM KILOBAUD/MICROCOMPUTING—A collection of the best articles that have recently appeared in Kilobaud/MICROCOMPUTING. Included is material on the TRS-80 and PET systems, CP/M, the 8080/8085/Z80 chips, the ASR-33 terminal. Data base management, word processing, text editors and file structures are covered too. Programming techniques and hardware construction projects for modems, high speed cassette interfaces and TVTs are also included in this large format, 200 plus page edition. BK7311 \$10.95.*

DON'T (or How to Care for Your Computer)—by Rodney Zaks. In plain language, with numerous illustrations, this book tells all the do's and don't's of the care, preservation and correct operation of the small computer system. Specific chapters cover each piece of hardware and software, as well as safety and security precautions and help for problem situations. Have your computer work right the first time and keep it working. No technical background required. For all computer users. BK1237 \$11.95.

YOUR FIRST COMPUTER—by Rodney Zaks. Whether you are using a computer, thinking about using one or considering purchasing one, this book is indispensable. It explains what a computer system is, what it can do, how it works and how to select various components and peripheral units. It is written in everyday language and contains invaluable information for the novice and the experienced programmer. (The first edition of this book was published under the title "An Introduction to Personal and Business Computing.") BK1191 \$8.95*

MICROPROCESSOR INTERFACING TECHNIQUES—by Austin Lesca & Rodney Zaks—will teach you how to interconnect a complete system and interface it to all the usual peripherals. It covers hardware and software skills and techniques, including the use and design of model buses such as the IEEE 488 or S-100. BK1037 \$17.95.*



AN INTRODUCTION TO MICROCOMPUTERS, VOL. 1—2nd Edition completely revised. Dedicated to the basic concepts of microcomputers and hardware theory. The purpose of Volume I is to give you a thorough understanding of what microcomputers are. From basic concepts (which are covered in detail), Volume I builds the necessary components of a microcomputer system. This book highlights the difference between minicomputers and microcomputers. BK1030 \$12.99.*

THE NEW HOBBY COMPUTERS—This book takes it from where Hobby Computers Are Here! leaves off, with chapters on Large-Scale Integration, how to choose a microprocessor chip, an introduction to programming, low-cost I/O for a computer, computer arithmetic, checking memory boards... and much, much more! Don't miss this tremendous value! BK7340 Only \$4.95.*

AN INTRODUCTION TO MICROCOMPUTERS, VOL. 0—The Beginner's Book—Written for readers who know nothing about computers—for those who have an interest in how to use computers—and for everyone else who must live with computers and should know a little about them. The first in a series of 4 volumes, this book will explain how computers work and what they can do. Computers have become an integral part of life and society. During any given day you are affected by computers, so start learning more about them with Volume 0. BK1130 \$7.95.*

HOBBY COMPUTERS ARE HERE!—If you want to come up to speed on how computers work—hardware and software—this is an excellent book. It starts with fundamentals and explains the circuits and the basics of programming, along with a couple of TVT construction projects, ASCII, Baudot, etc. This book has the highest recommendations as a teaching aid. BK7322 \$4.95.*

PRICES SUBJECT TO CHANGE WITHOUT NOTICE

*Use the order card in this magazine or itemize your order on a separate piece of paper and mail to Microcomputing Book Department • Peterborough NH 03458. Be sure to include check or detailed credit card information. No C.O.D. orders accepted. All orders add \$1.50 for first book, \$1.00 each additional book, \$10.00 per book foreign air-mail. Please allow 4-6 weeks for delivery. Questions regarding your order? Please write to Customer Service at this address.

FOR TOLL FREE ORDERING CALL 1-800-258-5473

Programming



TRS-80 ASSEMBLY LANGUAGE—by Hubert S. Howe, Jr. This book incorporates into a single volume all the pertinent facts and information you need to know to program and enjoy the TRS-80. Included are clear presentations of all introductory concepts, completely tested practical programs and subroutines, details of ROM and RAM and disk operating systems, plus comprehensive tables, charts and appendices. Suitable for the first time user or more experienced users. BK1217 \$9.95.*

INSIDE LEVEL II—For machine language programmers. This is a comprehensive reference guide to the Level II ROMs, allowing easy utilization of the sophisticated routines they contain. It concisely explains set-ups, calling sequences, variable passage and I/O routines. Part II presents an entirely new composite program structure which unloads under the SYSTEM command and executes in both BASIC and machine code with the speed and efficiency of a compiler. Special consideration is given to disk systems. BK1183 \$15.95.*

PROGRAMMING THE Z-80—by Rodney Zaks. Here is assembly language programming for the Z-80 presented as a progressive, step-by-step course. This book is both an educational text and a self-contained reference book, useful to both the beginning and the experienced programmer who wish to learn about the Z-80. Exercises to test the reader are included. BK1122 \$15.95.*

Z-80 ASSEMBLY LANGUAGE PROGRAMMING—by Lance A. Leventhal. This book thoroughly covers the Z-80 instruction set, abounding in simple programming examples illustrating software development concepts and actual assembly language usage. Features include Z-80 I/O devices and interfacing methods, assembler conventions, and comparisons with 8080A/8085 instruction sets and interrupt structure. BK1177 \$16.99.*

PROGRAMMING THE 6502 (Third Edition)—Rodney Zaks has designed a self-contained text to learn programming, using the 6502. It can be used by a person who has never programmed before, and should be of value to anyone using the 6502. The many exercises will allow you to test yourself and practice the concepts presented. \$13.95.* BK1005

6502 APPLICATIONS BOOK—Rodney Zaks presents practical-application techniques for the 6502 microprocessor, assuming an elementary knowledge of microprocessor programming. You will build and design your own domestic-use systems and peripherals. Self-test exercises included. BK1006 \$12.95.*

Cook Books

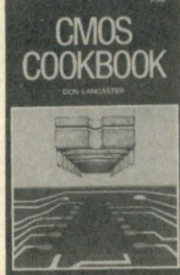

CMOS COOKBOOK—by Don Lancaster. Details the application of CMOS, the low power logic family suitable for most applications presently dominated by TTL. Required reading for every serious digital experimenter! BK1011 \$10.50.*

TTL COOKBOOK—by Don Lancaster. Explains what TTL is, how it works, and how to use it. Discusses practical applications, such as a digital counter and display system, events counter, electronic stopwatch, digital voltmeter and a digital tachometer. BK1063 \$9.50.*

TVT COOKBOOK—by Don Lancaster. Describes the use of a standard television receiver as a microprocessor CRT terminal. Explains and describes character generation, cursor control and interface information in typical, easy-to-understand Lancaster style. BK1064 \$9.95.*

NANOS SYSTEM REFERENCE CARDS FOR APPLE II, APPLE II PLUS, MODELS I, II, III AND COLOR COMPUTER

At last! No more flipping through the pages of the Basic manual! No more working through the maze of machine language instructions! These cards completely summarize the Basic and Assembler

manuals! FEATURES INCLUDE: memory map, eyeball graphics, math instructions, basic commands, store instructions, basic functions, load instructions, basic statements, move instructions, special keys, exchange instructions, print using examples, shift instructions, basic special characters, compare instructions, basic and assembler messages and codes, branch instructions, basic facts, data alteration instructions, reserved words, I/O instructions, ROM routines, complete character chart with graphics and space-compression codes, hex-dec chart, control code cross-reference, assembler instructions commands and operators, screen line layout, editor commands & subcommands, condition code easy access. Designed as a fold-up, accordion-style card, fits in your pocket. Panels organized for optimum speed for reference.

- Model I: Basic only FC1001 \$2.95
- Model I: BASIC and Assembler FC1002 \$4.95
- Model II: BASIC and Assembler FC1005 \$5.95
- Model III: BASIC only FC1004 \$3.95
- Model III: BASIC and Assembler FC1003 \$5.95
- Color: BASIC and Extended FC1006 \$4.95
- Apple II: BASIC only FC1007 \$3.95
- Apple II: BASIC & 6502 FC1008 \$4.95

Z-80

6502

68000/6809

PET/CBM PERSONAL COMPUTER GUIDE—by Adam Osborne and Carol Donahue. REVISED SECOND EDITION This is the book that will show you what the Commodore PET or CBM can do and how to get your's up and running. Designed as a self-teaching BASIC tutorial, the book will teach you both BASIC and CBM BASIC, yet it assumes no knowledge of computers or programming. Included are: complete operating instructions, Description of all PET/CBM BASIC statements, optimal programming techniques and solutions to many programming problems. BK1231 \$15.00

SOME COMMON BASIC PROGRAMS, APPLE II EDITION—by Lon Poole et al. A powerful collection of financial, statistical, home management and mathematics programs—76 in all—Each program is presented with BASIC source code, operating instructions and descriptions. If you're a beginning programmer you can learn from this book what well designed and documented programs look like. BK1232 \$14.95

UNDERSTANDING YOUR VIC VOL. 1: BASIC PROGRAMMING—by David Schultz. For the beginning VIC programmer—this book is full of examples and exercises (with expected results included as immediate feedback) that will help you to quickly and easily learn about the VIC. Included are chapters on program design with the use of pseudo code and data dictionaries to refine programming problems, and on VIC color and sound features. A fine learn-by-doing programming guide. BK1234 \$11.95.

6502 ASSEMBLY LANGUAGE PROGRAMMING—by Lance A. Leventhal. This book provides comprehensive coverage of the 6502 microprocessor assembly language. Leventhal covers over 80 programming examples from simple memory load loops to complete design projects. Features include 6502 assembler conventions, input/output devices and interfacing methods and programming the 6502 interrupt system. BK1176 \$16.99.*

THE APPLE II USER'S GUIDE—by Lon Poole, Martin McNiff, and Steven Cook. This guide is the key to unlocking the full power of your Apple II or Apple II Plus. Topics include: "Applesoft and Integer BASIC Programming"—especially how to make the best use of Apple's sound, color and graphics capabilities. "Machine Level Programming." "Hardware Features"—which covers the disk drive and printer, and "Advanced Programming"—describing high resolution graphics techniques and other advanced applications. Well organized and easy to use. BK1220 \$15.00.*

6809 MICROCOMPUTER PROGRAMMING AND INTERFACING—by Andrew C. Staugaard, Jr. Getting involved with Tandy's new Color Computer? If so, this new book from the Blacksburg Group will allow you to exploit the awesome power of the machine's 6809 microprocessor. Detailed information on processor architecture, addressing modes, register operation, data movement, arithmetic logic operations, I/O and interfacing is provided, as well as a review section at the end of each chapter. Four appendices are included covering the 6809 instruction set, specification sheets of the 6809 family of processors, other 6800 series equipment and the 6809/6821 Peripheral Interface Adapter. This book is a must for the serious Color Computer owner. BK1215 \$13.95.*

68000 MICROPROCESSOR HANDBOOK—by Gerry Kane. Whether you're currently using the 68000, planning to use it, or simply curious about one of the newest and most powerful microprocessors, this handbook has all the answers. A clear presentation of signal conversions, timing diagram conventions, functional logic, three different instruction set tables, exception processing, and family support devices provides more information about the 68000 than the manufacturer's data sheets. A stand alone reference book which can also be used as a supplement to *An Introduction to Microcomputers: Vol. 2—Some Real Microprocessors*. BK1216 \$6.99.*

68000 ASSEMBLY LANGUAGE PROGRAMMING—by Gerry Kane, et al. A straightforward self teaching text book on assembly language programming for the 68000 microprocessor. This book contains the entire instruction set, describes the function of assemblers and assembly instructions and discusses basic software development concepts. A large number of practical programming examples are included. BK1233 \$16.99

MICROCOMPUTING CODING SHEETS *Microcomputing's* dozen or so programmers wouldn't try to work without these handy scratch pads, which help prevent the little errors that can cost hours and hours of programming time. Available for programming in Assembly/Machine Language (PD1001), which has columns for address, instruction (3 bytes), source code (label, op code, operand) and comments; and for BASIC (PD1002) which is 72 columns wide. 50 sheets to a pad. \$2.39.*

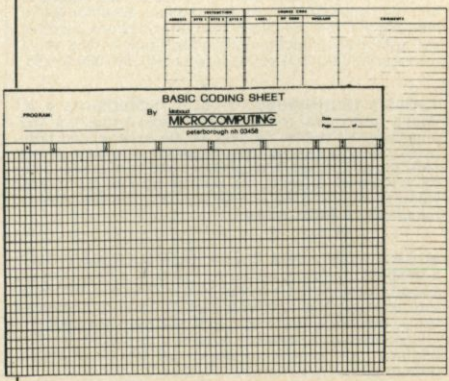

PRICES SUBJECT TO CHANGE WITHOUT NOTICE

*Use the order card in this magazine or itemize your order on a separate piece of paper and mail to *Microcomputing* Book Department • Peterborough NH 03458. Be sure to include check or detailed credit card information. No C.O.D. orders accepted. All orders add \$1.50 for first book, \$1.00 each additional book, \$10.00 per book foreign air-mail. Please allow 4-6 weeks for delivery. Questions regarding your order? Please write to Customer Service at this address.

FOR TOLL FREE ORDERING CALL 1-800-258-5473

Basic & Pascal

INTRODUCTION TO TRS-80 LEVEL II BASIC AND COMPUTER PROGRAMMING—by Michael P. Zabinski. Written by an experienced educator, this is the book for those beginners who want to learn about computers without having to become an expert. It has practical programs, useful line-by-line comments, excellent flowcharts accompanied by line numbers and over 200 exercises which help the reader assess progress, reinforce comprehension, and provide valuable practical experience. BK1219 \$10.95.*

LEARNING TRS-80 BASIC—by David A. Lien. Dr. Lien, who is the author of *THE BASIC HANDBOOK* and the original *RADIO SHACK LEVEL I USER'S MANUAL*, has compiled a tutorial which includes portions of the original *USER'S MANUAL* and most of *LEARNING LEVEL II* along with extensive additions. It will completely cover the TRS-80 Models I, II, III, and 16 (sorry, not the color or pocket computers). It is, of course, written in the easy learning style which readers of Dr. Lien's books have come to enjoy. BK1175 \$19.95.

THE BASIC HANDBOOK—SECOND EDITION—by David Lien. This book is unique. It is a virtual *ENCYCLOPEDIA OF BASIC*. While not favoring one computer over another, it explains over 250 BASIC words, how to use them and alternate strategies. If a computer does not possess the capabilities of a needed or specified word, there are often ways to accomplish the same function by using another word or combination of words. That's where the *HANDBOOK* comes in. It helps you get the most from your computer, be it a "bottom-of-the-line" micro or an oversized monster. BK1174 \$19.95.*

BASIC BASIC (2ND EDITION)—by James S. Coan. This is a textbook which incorporates the learning of computer programming using the BASIC language with the teaching of mathematics. Over 100 sample programs illustrate the techniques of the BASIC language and every section is followed by practical problems. This second edition covers character string handling and the use of data files. BK1026 \$10.50.*

ADVANCED BASIC—Applications including strings and files, coordinate geometry, area, sequences and series, simulation and graphing and games. BK1000 \$10.75.*

INTRODUCTION TO PASCAL—by Rodney Zaks. A step-by-step introduction for anyone wanting to learn the language quickly and completely. Each concept is explained simply and in a logical order. All features of the language are presented in a clear, easy-to-understand format with exercises to test the reader at the end of each chapter. It describes both standard PASCAL and UCSD PASCAL—the most widely used dialect for small computers. No computer or programming experience is necessary. BK1189 \$14.95.*

PROGRAMMING IN PASCAL—by Peter Grogono. The computer programming language PASCAL was the first language to embody in a coherent way the concepts of structured programming, which has been defined by Edsger Dijkstra and C.A.R. Hoare. As such, it is a landmark in the development of programming languages. PASCAL was developed by Niklaus Wirth in Zurich; it is derived from the language ALGOL 60 but is more powerful and easier to use. PASCAL is now widely accepted as a useful language that can be efficiently implemented, and as an excellent teaching tool. It does not assume knowledge of any other programming language and therefore suitable for an introductory course. BK1140 \$12.95.*

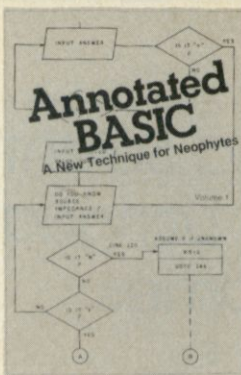

NEW

NEW

ANNOTATED BASIC—A NEW TECHNIQUE FOR NEO-PHYTES.—BASIC programming was supposed to be simple—a beginner's programming language which was so near to English that it could be easily understood. But, in recent years, BASIC has become much more powerful and therefore much more difficult to read and understand. BASIC simply isn't basic anymore.

Annotated BASIC explains the complexities of modern BASIC. It includes complete TRS-80* Level II BASIC programs that you can use. Each program is annotated to explain in step-by-step fashion the workings of the program. Programs are flowcharted to assist you in following the operational sequence. And—each chapter includes a description of the new concepts which have been introduced.

Annotated BASIC deals with the hows and whys of TRS-80 BASIC programming. How is a program put together? Why is it written that way? By observing the programs and following the annotation, you can develop new techniques to use in your own programs—or modify commercial programs for your specific use. *Annotated BASIC Volume 1* BK7384 \$10.95. *Annotated BASIC Volume 2* BK7385 \$10.95. Order Both Volumes and Save! BK738402 \$18.95



50 BASIC EXERCISES—by J. P. Lamoitier. This book is structured around the idea that the best way to learn a language is through actual practice. It contains 50 completely explained exercises: statement and analysis of the problem, flowcharts, programs and actual runs. Program subjects include mathematics, business, games, and operations research, and are presented in varying levels of difficulty. This format enables anyone to learn BASIC rapidly, checking their progress at each step. BK1192 \$12.95.*

Business

THEORY Z—How American Business Can Meet the Japanese Challenge—by William Ouchi. Why are the Japanese catching up and surpassing American industrial productivity? What allows Japanese industrialists to offer guaranteed lifetime employment to their workforce? This book will help you understand the Theory Z managerial philosophy and its implications for the American corporate future. Examples are given of the American industrial giants already operating under Z-style management, and the impact of this style on the quality of their executives and workers is explored. A must for the alert businessman, large or small. BK1226 \$12.95.*

SO YOU ARE THINKING ABOUT A SMALL BUSINESS COMPUTER—by Richard G. Canning and Nancy C. Leeper. For a well-organized manual on the process of selecting the right computer system for your small business, this text can't be excelled. Designed to introduce the novice in data and word processing to the real benefits of computerization, the book is filled with money- and time-saving tips, photos of equipment, lists of suppliers, prices, explanations of computer terminology, and helpful references to additional sources of information. Everyone contemplating a first computer installation should have this book. BK1222 \$14.00*

PAYROLL WITH COST ACCOUNTING—IN BASIC—by L. Poole & M. Borchers, includes program listings with remarks, descriptions, discussions of the principle behind each program, file layouts, and a complete user's manual with step-by-step instructions, flowcharts, and simple reports and CRT displays. Payroll and cost accounting features include separate payrolls for up to 10 companies, time-tested interactive data entry, easy correction of data entry errors, job costing (labor of distribution), check printing with full deduction and pay detail, and 16 different printed reports, including W-2 and 941 (in CBASIC). BK1001 \$20.00.*

SOME COMMON BASIC PROGRAMS—Published by Adam Osborne & Associates, Inc. Perfect for non-technical computerists requiring ready-to-use programs. Business programs, plus miscellaneous programs. Invaluable for the user who is not an experienced programmer. All will operate in the stand-alone mode. BK1053 \$14.99

PIMS: PERSONAL INFORMATION MANAGEMENT SYSTEM—Learn how to unleash the power of a personal computer for your own benefit in this ready-to-use data-base management program. BK1009 \$11.95.*

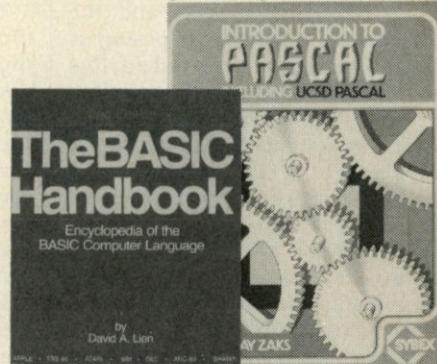

GAMES

40 COMPUTER GAMES FROM KILOBAUD MICROCOMPUTING—Forty games in all in nine different categories. Games for large and small systems, and even a section on calculator games. Many versions of BASIC used and a wide variety of systems represented. A must for the serious computer gamesman. BK7381 \$7.95.*

BASIC COMPUTER GAMES—Okay, so once you get your computer and are running in BASIC, then what? Then you need some programs in BASIC, that's what. This book has 101 games for you from very simple to real buggers. You get the games, a description of the games, the listing to put in your computer and a sample run to show you how they work. Fun. Any one game will be worth more than the price of the book for the fun you and your family will have with it. BK1074 \$7.50.*

MORE BASIC COMPUTER GAMES—Edited by David H. Ahl. More fun in BASIC! 84 new games from the people who brought you *BASIC Computer Games*. Includes such favorites as Minotaur (battle the mythical beast) and Eliza (unload your troubles on the doctor at bargain rates). Complete with game description, listing and sample run. BK1182 \$7.50.*

WHAT TO DO AFTER YOU HIT RETURN—PCC's first book of computer games... 48 different computer games you can play in BASIC... programs, descriptions and many illustrations. Lunar Landing, Hamurabi, King, Civel 2, Qubic 5, Taxman, Star Trek, Crash, Market, etc. BK1071 \$16.50.*

Money making

HOW TO MAKE MONEY WITH COMPUTERS—In 10 information-packed chapters, Jerry Felsen describes more than 30 computer-related, money-making, high profit, low capital investment opportunities. BK1003 \$15.00.*

HOW TO SELL ANYTHING TO ANYBODY—According to *The Guinness Book of World Records*, the author, Joe Girard, is "the world's greatest salesman." This book reveals how he made a fortune—and how you can, too. BK7306 \$2.25.*

THE INCREDIBLE SECRET MONEY MACHINE—by Don Lancaster. A different kind of "cookbook" from Don Lancaster. Want to slash taxes? Get free vacations? Win at investments? Make money from something that you like to do? You'll find this book essential to give you the key insider details of what is really involved in starting up your own money machine. BK1178 \$5.95.*

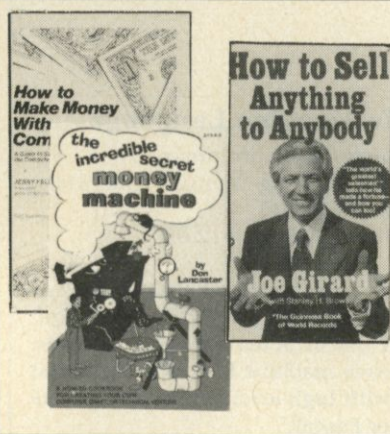

PRICES SUBJECT TO CHANGE WITHOUT NOTICE

*Use the order card in this magazine or itemize your order on a separate piece of paper and mail to Microcomputing Book Department • Peterborough NH 03458. Be sure to include check or detailed credit card information. No C.O.D. orders accepted. All orders add \$1.50 for first book, \$1.00 each additional book, \$10.00 per book foreign air-mail. Please allow 4-6 weeks for delivery. Questions regarding your order? Please write to Customer Service at this address.

FOR TOLL FREE ORDERING CALL 1-800-258-5473

MICROCOMPUTING BOOKS

Pascal for Engineers and Scientists Master Apple Machine Language PET Games, Games, Games Playing the Market Definitely Not for Dilettantes

Pascal Programs for Scientists and Engineers

Alan R. Miller
Sybex, 1981
2344 Sixth St.
Berkeley, CA 94710
Paperback, 374 pp., \$16.95

This book shows how far the micro-computer industry has come from its game-playing origins; Miller leads us through the mazes of Gauss-Jordan eliminations, Shell-Metzner sorts and the Romberg method instead of exposing us to caves, dragons or alien invaders. It is an important addition to the growing group of publications which help micro-computer owners take full advantage of the capabilities of these remarkable devices. The special advantages of Pascal for development and maintenance of complex programs are well illustrated. The book is not for absolute beginners (unless you are content to copy and use programs without making any adaptations for your own use), but it makes an excellent complement to an introductory book such as Luehrmann and Peckham's *Apple Pascal—A Hands-On Approach*. (For a review of this book see *Microcomputing*, April 1982, p. 180.)

Among the best features of the book are the many clear examples of top-down programming, a widely cited advantage of Pascal. Time and again, Miller takes the reader through derivation of the equations on which a program is based, writes a simple version which is quite easy to understand but does not give the desired precision, capacity, etc., and then goes on to progressively more complex versions with additional features. Anyone who works through these programs will learn a lot about programming in general and Pascal in particular. People in a hurry can just enter the final versions and still get their money's worth.

My initial impression of the book was that the title is backwards; it seems to be

written for engineers first and scientists second. Nevertheless, scientists who make extensive use of simultaneous equations and complex curve fitting should find it useful, at least in some parts.

Like the other Sybex books I have seen, it is very well produced; the type is clear, easy to read and well spaced. The programs are the easiest to read and enter that I have ever seen. Typesetting doesn't usually merit comment, but it is really quite remarkable in Miller's book, and it is certainly much better than in most programming books.

The programs in the book are written in Standard Pascal; this has some advantages and some disadvantages. The programs can be used on any computer which has a Pascal implementation, but they can't take advantage of special features (such as graphics) which make some versions of the language so attractive. I think the use of Standard Pascal was a wise choice, and Miller has been very careful to make as clear as possible the ways in which various extensions of the language might be utilized. The generality of Miller's approach is shown by the first chapter which presents programs for evaluating the limitations of various Pascal compilers, and programming approaches to bypass some compiler deficiencies are specified. It's hard to imagine a Pascal implementation with which this book could not be used.

The second chapter deals with simple mean and standard deviation calculations and random number generations. A chapter on vector and matrix operations leads logically into solution of simultaneous equations, and this is followed by a chapter on linear curve fitting. (This chapter is enhanced by a rather clever procedure for simulating curve plots using a conventional printer; the 80-character resolution is clearly not suitable for publications, but it does give a good idea of how well the curve fits the points.) Subsequent chapters deal with sorting of numerical data (bubble, Shell-Metzner and quick sorts are covered), advanced curve

fitting and equation solving, and numerical integration of the area under a curve by several methods (trapezoidal rule, Simpson's Integration and the Romberg method). Finally, two approaches to non-linear curve-fitting equations are presented, and the last chapter includes advanced applications such as calculation of normal distribution curves and the Gaussian, Gamma and Bessel functions. A useful appendix includes a summary of the major features of Standard Pascal and a brief bibliography precedes the rather limited index.

From my point of view, the only important deficiency in the book is its lack of statistical programs. Only mean and standard deviation calculations are presented. For my fellow biomedical scientists, an additional chapter including standard error calculations, t tests, analysis of variance, etc., would have enhanced the usefulness of this attractive book. My advice to prospective purchasers is to spend a few minutes in your local computer store looking over the book to see if it fits your needs. If it does, buy it; you certainly won't have any trouble following, entering or using the programs.

James R. Florini
Syracuse, NY

Apple Machine Language

Don Inman and Kurt Inman
Reston Publishing Company, Inc., 1981
Reston, VA 22090
Paperback, 224 pp., \$12.95

Many computer hobbyists avoid machine-language programming. Convinced that it is too difficult to master, they leave machine language alone and work with high-level languages such as Basic or Pascal.

Apple Machine Language explains programming in the Apple's native tongue in a clear and understandable manner. It guides the reader from Basic,

through the monitor program, and finally to the Apple mini-assembler. Each segment of the book is filled with numerous examples.

The book is divided into twelve chapters and three appendices. It's well organized and reveals careful and thoughtful planning. It covers fairly advanced topics as well, such as binary and BCD mathematical methods, multiple byte arithmetic and two's complement representation. Practical uses for the various techniques are given in graphics, arithmetic and game examples.

Exercises are given at the end of each chapter. These are helpful in determining if the preceding information was learned correctly. Answers to the exercises are provided as well. Though the book is intended for use by an individual, it can easily be adapted for a classroom situation.

In order to get the most out of *Apple Machine Language*, it would help to know something about Basic and be familiar with the Apple II computer. Without a bit of prior knowledge, some things in the book might be a bit confusing.

Since the book uses the Apple mini-assembler, it is not possible to do many of the examples on an Apple II Plus without the Integer Basic card. This is because the mini-assembler, step and trace, and Sweet 16 interpreter are located in the Integer Basic ROMs. The book is written assuming the user has both Integer and Applesoft Basic available, although all examples are given in Applesoft Basic.

Apple Machine Language is a very good introduction to machine and assembly language. It removes the mystique that surrounds programming in zeros and ones, and makes it understandable, practical and rewarding.

Robert Swirsky
Cedarhurst, NY

PET Games and Recreations

Mac Oglesby, Len Lindsay and
Dorothy B. Kunkin
Reston Publishing Co., Inc., 1981
Reston, VA 22090
Paperback, 256 pp., \$9.95

PET Games and Recreations contains program listings for twenty simple games and a tongue-in-cheek discussion of PET programming techniques. The programs provided are intended for use with both new and old versions of the Commodore PET/CBM computers. Most of the programs make use of PET's effective but limited screen graphics capabilities. Do not expect any exotic graphics from these programs.

The collection of games includes several simple games designed and/or revised for use with the PET. They have been separated into four categories—games of

chance like *In Between*, plan-ahead games like *Tic Tac Toe* and *Brainbuster*, reasoning games that include the classic *Hurkle*, and language and counting skills games such as *Crossword Puzzle*.

It is strange that two types of games that are best suited to PET's limited graphics capabilities are not represented in this book. Real-time action games (like *Pong* or *Breakout*) and Adventure games that are entertaining but use few graphics are absent.

Six recreational project programs that do provide entertaining activities using bouncing balls and other animation complete the program selection of the book.

The last chapter is a frivolous discussion of some unusual PET programming techniques, added almost as an afterthought.

Each of the program listings is introduced with a commentary about game background. The program listings reproduced in the book were printed using a NEC Spinwriter. This method provides clear, legible print and should insure accurate program listings.

It took about an hour to input the listing of *In Between*. Two hours of debugging and getting the graphics to look right followed. I discovered that it is difficult to count spaces and interpret graphic symbols correctly, even from the Spinwriter listing. I also noted that a few lines of the *In Between* listing are not reproduced as intended. Lines 25216, 25219 and 25264 use spaces instead of the backspace character (←). The symbol for this character is supposed to be a tilde (˜) according to the introduction in the text.

At least nine of the programs contained in the book are available on a single cassette tape from Reston Publishers Software, 11480 Sunset Hills Road, Reston, VA 22090. My experience indicates that this tape may be worthwhile, especially if you are interested in more than a few of the games included in *PET Games and Recreations*.

An investment in *PET Games and Recreations* should be worthwhile if you have never modified any of the many games available in the public domain to run with PET graphics.

S.J. Gradijan
Carrollton, TX

Playing the Stock & Bond Markets with Your Personal Computer

L. R. Schmeltz
Tab Books Inc., 1981
Blue Ridge Summit, PA 17214
Paperback, 308 pp., \$9.95

L. R. Schmeltz says his book is aimed at relative novices—in regard to both computer programming and stock market knowledge. His aim is accurate. Ex-

perienced programmers and investors probably will learn little. But if you are indeed a novice in both areas, you should get a reasonable return on your ten dollars.

The programs included are in Basic, specifically Applesoft. Suggestions for converting to other Basics are included, but fall far short of hitting the mark, at least as compared to Microsoft Basic. Don't do what I did, namely type in the first long program with the thought of doing the rework on the screen. I ended up with seven pages of Basic code—over 300 lines—which I abandoned before getting it to run.

I'm a sucker for trying programs. I always figure I'll learn something even if I have no particular use for a specific program. And such was the case here. "Fundamental Analyst" uses both sequential and random files, a personal weak point. Great learning stuff, I thought. Well I learned all right. I can now use, at least hesitantly, Microsoft's file systems—but they're so different from Apple's I would have had to completely redo Schmeltz's program. And I didn't really want that particular program that badly.

"Fundamental Analyst" requests 17 pieces of financial data on each of three companies. The data was difficult to collect, in that I needed an annual report, Value Line Investment Survey reports and current newspapers to amass them. And I still had question marks on some items. Current assets and liabilities, sure. But year end inventory? Par value of preferred stock? And annual reports are just that—annual. Getting truly current data would be an almost impossible chore, certainly if any number of firms were to be examined.

The data was used to calculate various financial ratios, such as operating profit margin, current ratio, and sales to fixed assets. Many of the results might be better found in Standard and Poor data sheets or from the Value Line service (available in libraries if you don't want to spend the \$300 a year).

The second program is "Stock Trend Analyst," which calculates a moving average over a period of time. Again, a major data problem if you want to look at one stock one day and several others the next day. Still, getting the program up and running will add to the skills of a non-professional programmer.

The final program is "Dollar Cost Averaging Analyst," which simply keeps track of shares and share prices of a stock you buy on a dollar-averaging basis (that is, buying a constant dollar amount of stock at fixed intervals). The theory is you buy fewer shares when the price is high, more when the price is low, and your average price is thus reasonable. Such an investment program is most easily expedited when buying mutual fund shares, a procedure that clearly negates the need for a computer program to follow the re-

sults. But again, by getting the program up and running you'll end up a bit smarter.

What about the stock investment advice generally? Not bad. It's very basic, and my favorite approach is not discussed (select an industry group, then select the best-looking stock within that group). Apart from a mildly distracting habit of using too many exclamation points (one is too many—two or three on a page is downright irritating), Schmeltz offers advice which is quite sound.

For investment novices, I would suggest first reading the classic *How to Buy Stocks* by Louis Engel (a Bantam paperback). This is the beginner's bible, frequently given to investors if they buy through a full-service broker.

Schmeltz includes an extensive bibliography, a glossary of computer terms, a handy glossary of investment terms, a list of additional information sources and a very interesting 18-page listing of commercially available investment programs—including an expanded package of his own, for Apple, of course.

The listings are large and clear. The few charts and tables are also clear but the photos are inexcusably muddy.

Is the book worth buying? Yes, for Apple users who would like to get some more programming practice while learning something about investment in common stocks. For non-Apple users, prob-

ably not. Schmeltz uses the Applesoft POKE graphics command to format the output to the screen—very unlike Microsoft use. And the awkwardness of the rest of the formatting commands will irritate those whose Basic offers print using (Schmeltz accurately notes how much neater the program could be with print using). Yes, conversion is possible, but at the cost of a lot of work—more than I was willing to do.

Although I personally found the programs themselves to be of marginal interest, I believe there are definite benefits to be gained from the book—you'll learn something about stock market investment and get some forced-draft practice in Applesoft.

**Dex Hart
Miami, FL**

Interfacing to S-100/IEEE 696 Microcomputers

Sol Libes and Mark Garetz
Osborne/McGraw-Hill, 1981
630 Bancroft Way
Berkeley, CA 94710
Paperback, 340 pp., \$15.99

Interfacing to S-100/IEEE 696 Microcomputers is exactly what the title im-

plies—it's the complete book on the philosophy, technique and methods of connecting any and all devices to the S-100 bus. There is virtually nothing that is left out of this work.

The book is not intended for the casual game dilettante or even the serious business programmer. The reader will need to have a thorough knowledge of electronics, including digital theory. The book assumes you understand digital logic functions, how to use TTL integrated circuits, how to read schematics and how to translate a schematic into a working circuit board. A basic knowledge of computer hardware is a must, and the ability to program in assembly language is an absolute necessity.

The book is marvelous. Everything you want to know about S-100 interfacing is in the book, including theory, specific hardware and circuits, and applications software both in flowchart form and actual assembly listings. The reader may have to dig a little to find the circuits he needs for his own application, but rest assured, they're in there. All he has to do is put them together. However, I must caution you—only the *interface* is discussed in the book, the peripherals themselves are not covered.

The text begins with a complete description of S-100 bus signals. The IEEE-696 standard is used as the basis of

Circle 188 on Reader Service card.

DAISY WHEEL

By SMITH-CORONA

SAVE \$500⁰⁰

...and more over all other popular Daisy Wheel Printers.

- 120 WORDS PER MINUTE • FRICTION FEED
- CHANGEABLE DAISY WHEEL TYPE FONTS
- CENTRONICS PARALLEL or RS232 INTERFACE

—CALL \$—

TOLL-FREE

800-257-6170

in New Jersey
609-428-3900

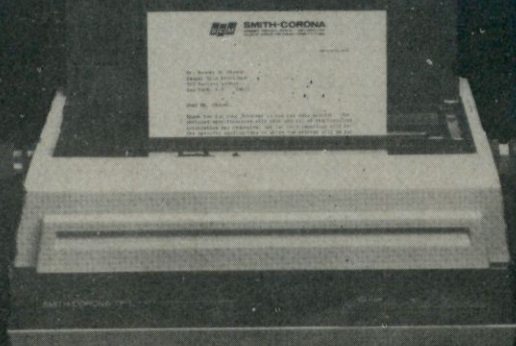

Rainbow™

P & P CORPORATION
P O BOX 362 • HADDONFIELD, N.J. 08033

Circle 92 on Reader Service card.

JPC PRODUCTS FOR

6800 COMPUTERS

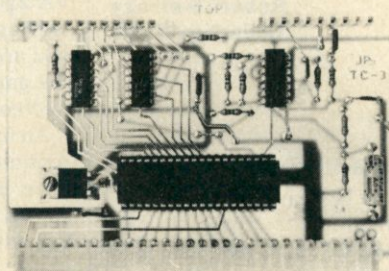

High Performance Cassette Interface

- **FAST** - 4800 Baud Loads 4K in 8 Seconds!
- **RELIABLE** - Error Rate Less Than 1 in 10⁸ Bytes.
- **CONVENIENT** - Plugs Directly Into The **SWTPC**.
- **PLUS** - A Fully Buffered 8 Bit Output Port Provided.
- **LOW COST** - \$59.95 For Complete Kit.
- **OPTIONAL** - CFM/3 File Manager.

Manual & Listing \$19.95
(For Cassette Add) \$ 6.95

TERMS: CASH, MC or VISA:

Shipping & Handling \$3.00



JPC PRODUCTS CO.
Phone (505) 294-4623
12021 Paisano Ct.
Albuquerque, N.M. 87112

all the discussions, as this standard has become the yardstick against which all S-100 systems are measured. For those who still use the older buses, a comparison of a few of the other definitions are given, as well as the IEEE-696 standard. The book defines the function, polarity, whether active high or active low, symbol, and timing relationships for all 100 lines on the S-100 bus. There is even a section on proper termination of the individual lines.

There is an entire chapter on the timing relationships for the signals on the bus, and how they apply to various purposes and applications. Complete diagrams of the signals and their relative timing are given. Anyone who has ever tried to design a circuit board for any bus will appreciate this section.

The text shows all the circuits needed to derive all sorts of chip enable signals from the bus lines. The circuits for memory read and write, I/O transfers, wait states, buffers and many others are shown in detail. There is a discussion of address decoders, a full list of memory chips, and how to make both RAM (random access memory) and ROM (read only memory) boards using many of the popular RAM and EPROM chips.

Input and output is the most common use of interfacing to any computer. The book covers it well and in great detail.

There is a complete discussion of I/O ports, I/O mapping, memory mapping and handshaking. We see at every turn the specific circuits and chips to be used. Both parallel and serial interfacing are covered, with several methods of doing each with many of the popular interfacing chips, including the popular 6820, 8255 and 6520. The short section on handshaking is written as clearly as I have ever seen it done.

There is an entire chapter on the hazards and pitfalls (with solutions) of interfacing to the real world. Unfortunately, it leaves off much of the theory of ADCs and DACs, but a complete treatment of these subjects can (and has) taken an entire book all by itself.

The serious computer enthusiast or technician will find the chapter on interrupt techniques very useful. There is also a whole chapter on timers and counters, which every person who uses microcomputers in scientific applications will find indispensable.

For the hobbyist, experimenter, technician or scientific user, the last chapter is one called simply, Useful Circuits, which is a glorious hodgepodge of little tricks of the trade.

There is, naturally, a collection of full appendices.

Whenever I write a book review, I always try to be even-minded about the

book. I try to list an equal number of good and bad qualities. I ran into trouble with this work. I'm afraid that my list of shortcomings boils down to just a few picky little items. Those qualities are entirely concerned with some of the notation used in the text and the diagrams. My complaint is that the notation is not standard. Instead of drawing in pull-up resistors, they are represented by a diamond shape in the line they are supposed to pull up. A group of 8 or 16 wires all traveling to and from the same place is represented by a single line with the number of wires above it. In the text, and also in some drawings, active-low lines, instead of being represented by the mnemonic with a bar over it, are noted as the mnemonic with an asterisk in front of it. There is nothing wrong with this notation—it just takes a little getting used to, and could be confusing to someone not as well initiated in the finer points of electronic theory. I personally would have preferred the standard notations.

The S-100 bus has endured well. For those who want more from their S-100 computer than they can afford to buy, or for those who want to tinker with their machines and try to build peripherals or memory for it, this book gets my highest recommendation.

Gordon W. Wolfe
Metairie, LA

Circle 187 on Reader Service card.

DISCOUNT PRINTER RIBBONS

Brand New, Top Quality, Exact Replacement Ribbons & Cartridges. These Ribbons Produce Super Jet Black Impressions and Ultra Reliable Print Life. They Are Delivered to Your Door Promptly for Much Less Than Most Retail Stores

★SPECIAL! BUY 10 and GET ONE FREE!

YOUR PRINTER	PACK SIZE	RETAIL LIST**	YOUR WHOLESALE PRICE	SIZE	COMMENTS	CAT. ORDER #
ANADIX 9000 Series	1/pk	14.00 ea	14.00	500'	Nylon Jet Blk	C-777
CENTRONICS 700-703, 737, 779	3/pk	18.95/3 pk	11.95/3 pk	563" x 45'	Nylon Jet Blk	C-700
CENTRONICS 100, 101A, 102, 103, 300, 301, 306, 308, 330, 358, 398, 500, 501, 503, 508, 588, 620, 820	3/pk	26.33/3 pk	17.55/3 pk	1" x 108'	Nylon Jet Blk	C-100
CENTRONICS 704-705	1/pk	16.95 ea	13.95/Giant Cart	5'16" x 210'	Giant Cart	C-7045
DEC 1/2 x 40YD.	3/pk	17.77/3 pk	12.95/3 pk	1.2" x 120'	Double Spools	R-600
DEC 1/2 x 60YD.	3/pk	20.12/3 pk	14.25/3 pk	1.2" x 180'	Double Spools	R-644
DIABLO HYTYPE II (M/S BLK) HI YIELD. FITS 70 PRINTERS!	1/pk	9.31 ea	6.87 ea	5'16" x 'High Yield'	300,000 plus imp.	C-511
EPSON MX70, 80	1/pk	16.00 ea	16.00 ea	500"x60	Nylon Jet Blk	C-522
IBM "SILVER DOLLAR" Sys. 34, Sys. 32 MDLA, Series IMDL4974, 5256, 3287, 3770, 3771-3774, 4974, 5100, 5103, 5110, 5228, 5256, 5320MDLA	5/pk	5.80 ea	14.90/5 pk	9'16" x 30'	Nylon Jet Blk	R-300
IBM - HARMONICA 1/2" SERIES I, MOD 4973/II, 3200, 3289, MOD 2.	3/pk	9.42 ea	20.85/3 pk	1.2" x 108'	Nylon Jet Blk	C-350
NEC SPINWRITER	4/pk	23.40/3 cart	23.60/4 pk rb. reload	1.2" x 51'	Nylon/Ex Lng Life	R-400
QUME (FITS 80 PRINTER MODS)	3/pk	18.00/3 pk	13.95/3 pk	1.4" x 310'	Multistrike Film	C-525
RADIO SHACK DAISY WHEEL II	1/pk	24.95/3pk	8.25	250"	Mylar Multistrike	C-789
RADIO SHACK LPII, LPV	one/pk	13.95/cart	8.95/Reload rib" only	500" x 45'	Nylon Incl Instr	R-T3
RADIO SHACK LPII, LPV	3/pk	18.95/3 cart	11.95/3 cart	563" x 45'	Nylon Jet Blk	C-700
TELETYPE MOD 33, 28, 35, 37, 38, 88	10/pk	2.40 ea	13.90/10 pk	1.2" x 36'	Nylon Jet Blk	R-450
WANG M/S. 5541W, WC, 5581, WD, 6581W, 2281W	1/pk	6.85 ea	5.95 ea	5'16" x 393'	Multistrike Film	C-550

40% OFF!! OR MORE!

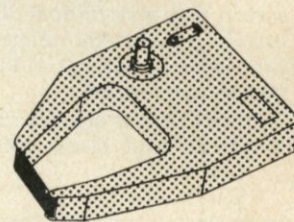

TERMS:

MINIMUM PURCHASE - \$20
PAYMENT BY: C.O.D. (UPS), CHECK, MASTER CARD, OR VISA CHARGE CARD.

VOLUME DISCOUNTS:

20 - 50 PACKS 10%
51 - 100 PACKS 15%
**UNDER \$20, ADD \$5 HANDLING.
**APPROX. RETAIL. PRICE VARIES.

ANCIE LABORATORIES

5200-J Philadelphia Way 301-345-6000 (Wash. D.C. Local)
Lanham, Maryland 20706 301-792-2060 (Balto. MD Local)
800-638-0987 (National)

NAME _____
ADDRESS _____
CITY _____ STATE _____ ZIP _____

ANCIE Laboratories
5200-J Philadelphia Way
Lanham, Maryland 20706

301-345-6000 (Wash. D.C. Local)
301-792-2060 (Balto. MD Local)
800-638-0987 (National)

QTY _____ CAT.# _____ AMT. _____

TOTAL _____

Check Enclosed
 C.O.D.
 VISA
 MASTER CHARGE
ACCT. # _____
EXP. DATE _____
MIN. ORDER \$20
PRICES SUBJECT TO CHANGE

More from Commodore

A wide range of computers has been introduced by Commodore Business Machines, Inc., The Meadows, 487 Devon Park Drive, Wayne, PA 19087. For games-and-graphics enthusiasts, the Max Machine is an inexpensive game machine with limited programming capability. It is built around the new 6510 microprocessor chip, and produces 16-color graphics. Using a special sound interface device, the Max can generate three voices with a nine-octave range; programmable ADSR, programmable filter and variable resonance are available for high-quality sound. Price is \$179.95. At the high end of the range, the BX256 is a multiprocessor computer for professional users. This 256K-byte micro features an 8088 16-bit processor for CP/M-86 compatibility. An attached 80-column green phosphor screen and built-in dual disk drives provide an efficient business package. The BX256 costs \$2995.

Commodore is also offering the P128 and B128 6509-

based microcomputers. Both come with 128K RAM (expandable to 256K), and both can be used for sound synthesis. The PET P128 interfaces with a color monitor or TV to display 16-color high-resolution graphics; it costs \$995. The Commodore B128 includes an adjustable 80-column display screen, detachable keyboard and dual drives; price is \$1695.

The Commodore 64 is an interesting hybrid, designed for versatility. It can use VIC 20 peripherals, and runs many programs and files written for PET and CBM computers. With the addition of an IEEE-488 cartridge, the Commodore 64 can run other Commodore peripherals, including CBM disk drives and printers. A PET emulator makes it operate like a PET in many respects, and a Z-80 add-on processor board turns the Commodore 64 into a CP/M machine. The basic configuration costs \$595. Reader Service number 467.

DEC Micros

Digital Equipment Corp., Maynard, MA 01754, has in-



Digital Equipment Corp.'s Rainbow 100 personal computer. The LA50 dot matrix printer, shown at left, is one of three printer options.

troduced a new series of modular microcomputers.

The Rainbow 100 runs both eight-bit and 16-bit software; the machine is designed to automatically read programs in either format without the need for operator intervention. Its CP/M-86/80 operating system makes it compatible with the widest possible variety of off-the-shelf software. It can be used as a stand-alone unit or be interfaced with DECmate, PDP-11 or other large systems. The Rainbow 100 has a detached low-profile keyboard, a standard 12-inch monitor, dual floppy disk

storage, 64K bytes of random-access memory, I/O ports and self-test diagnostics. It costs \$3245; upgrades are available.

The DECmate II is a multipurpose stand-alone system targeted primarily for office management. It features an advanced word processing software package, and can be linked to other computers via communications software. It runs COS-310 operating system and DIBOL programming language. Price is \$3745.

The Professional series, comprising the Professional 350 and 325 microcomputers, features the PDP-11/23 CPU chip, 256K bytes of memory and true multitasking operating system. The 325's 19-inch-wide system contains the processor, power supply, communications ports and dual five-inch floppy disk drives. The 350's wider unit also contains space for an optional Winchester drive. The Professional 325 is priced at \$3995; the Professional 350 is \$4995. The Winchester option costs \$3500. Other options are available. Reader Service number 471.



The Commodore Max Machine.

Small-Business Computer

Centered around the CP/M operating system, the T100



2MHZ 6809 SYSTEMS

GIMIX offers you a variety to choose from!

38 MB WINCHESTER SYSTEM \$17,498.99

HARDWARE FEATURES:

- ★ 2MHz 6809 CPU
- ★ 512KB Static RAM
- ★ 8 RS232C Serial Ports
- ★ 2 Parallel Ports
- ★ DMA Double Density Floppy Disk Controller
- ★ Dual 8" DSDD Floppy Disk System
- ★ Dual Winchester Subsystem with Two 19 MB 5 1/4" Winchester Drives

SOFTWARE FEATURES:

- ★ OS-9 LEVEL TWO Multi-User Operating System
- ★ OS-9 Debugger
- ★ OS-9 Text Editor
- ★ OS-9 Assembler

19 MB WINCHESTER SYSTEM \$8998.09

HARDWARE FEATURES:

- ★ 128K Static Ram
- ★ 2MHz 6809 CPU
- ★ 19 MB 5 1/4" Winchester DMA Subsystem
- ★ 4 RS232C Serial Ports
- ★ 1 MB 5 1/4" Floppy Disk Drive
- ★ DMA Double Density Floppy Disk Controller

SOFTWARE FEATURES:

- ★ OS-9 LEVEL TWO Multi-User Operating System
- ★ OS-9 Text Editor
- ★ OS-9 Debugger
- ★ OS-9 Assembler

128KB MULTI-USER SYSTEM \$6997.39

HARDWARE FEATURES:

- ★ 2MHz 6809 CPU
- ★ DMA Double Density Floppy Disk Controller
- ★ 128KB Static Ram
- ★ 2 RS232C Serial Ports
- ★ Dual 8" DSDD Floppy Disk System

SOFTWARE FEATURES: Your choice of either UniFLEX or OS-9 LEVEL TWO. Both are Unix-like Multi-User/Multi-Tasking Operating Systems.

56KB FLEX / OS-9 "SWITCHING" SYSTEM \$4148.49

HARDWARE FEATURES:

- ★ 2MHz 6809 CPU
- ★ 56K Static Ram
- ★ 2 RS232C Serial Ports
- ★ DMA Double Density Floppy Disk Controller
- ★ 2 Built-in 5 1/4" 40tr DSDD Disk Drives (80 Track DSDD Drive Option . . . add \$400.00)

SOFTWARE FEATURES:

- ★ GMXBUG monitor — FLEX Disk Operating System
- ★ OS-9 LEVEL ONE Multi-tasking operating system for up to 56K of memory.

WINCHESTER SUBSYSTEMS

Winchester packages are available for upgrading current GIMIX 6809 systems equipped with DMA controllers, at least one floppy disk drive, and running FLEX, OS-9 LEVEL ONE or OS-9 LEVEL TWO. The packages include one or two 19MB (unformatted) Winchester drives, DMA Hard Disk Interface, and the appropriate software drivers. The Interface can handle two 5 1/4" Winchester Drives, providing Automatic Data Error Detection and Correction: up to 22 bit burst error detection and 11 bit burst error correction.

Dual drives can be used together to provide over 30 MBytes of on line storage -- or use one for back-up of the other. (More convenient and reliable than tape backup systems.)

- #90 includes one 19MB Drive, Interface, and Software \$4288.90
- #91 includes two 19MB Drives, Interface, and Software \$6688.91

Contact GIMIX for systems customized to your needs or for more information.

50 HZ Export Versions Available

GIMIX Inc. reserves the right to change pricing and product specifications at any time without further notice.

GIMIX® and GHOST® are registered trademarks of GIMIX Inc.
FLEX and UniFLEX are trademarks of Technical Systems Consultants Inc.
OS-9 is a trademark of Microware Inc.

1337 WEST 37th PLACE
CHICAGO, ILLINOIS 60609
(312) 927-5510
TWX 910-221-4055

GIMIX inc.

1982 GIMIX Inc.

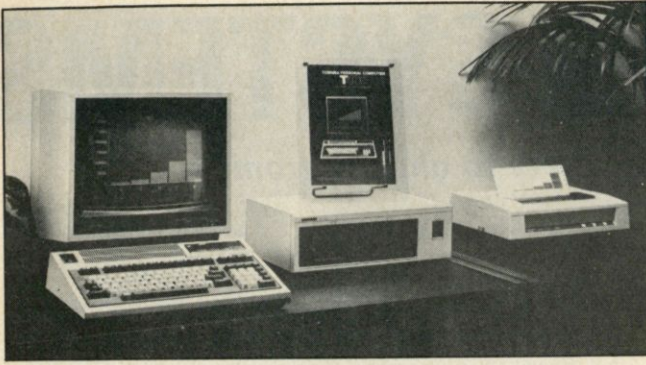

The T100, Toshiba's personal computer, is available with a variety of hardware and software options.

personal computer is aimed at operators of small businesses. The T100 boasts three standard memory units, up to 1M external floppy disk memory, several input/output video screen arrangements and high-resolution color graphics. For main memory, the T100 uses a 64K-byte RAM; it also uses a 32K-byte ROM for Basic language and a 16K RAM for video. Optional RAM and ROM packs offer the flexibility of easily transporting files and programs between home and office machines. The basic configuration costs \$2485.

Toshiba America, Inc., Information Systems Division, 2441 Michelle Drive, Tustin, CA 92680. Reader Service number 477.

NEC Advanced PC

The Advanced Personal Computer, from NEC Information Systems, Inc., 5 Militia Drive, Lexington, MA

02173, is based on the 16-bit 8086 microprocessor. This 128K-byte micro runs CP/M-86. The APC comes in two versions—color and monochrome. The monochrome model includes a single 1M eight-inch floppy disk drive and a green-screen monitor; price is \$3298. The color model has two disk drives and a high-resolution monitor that can display eight-color graphics; it costs \$4998. Reader Service number 473.

The Micro 68000

The Micro 68000, from Computer Systems Associates, Inc., is a self-contained trainer/prototyping system for engineers and technicians. It comes with a 6 A switching power supply, 20-key keyboard, 28-digit hexadecimal display, 80-bit binary display and keyboard monitor program. The Micro is the only trainer that allows direct entry of machine code.

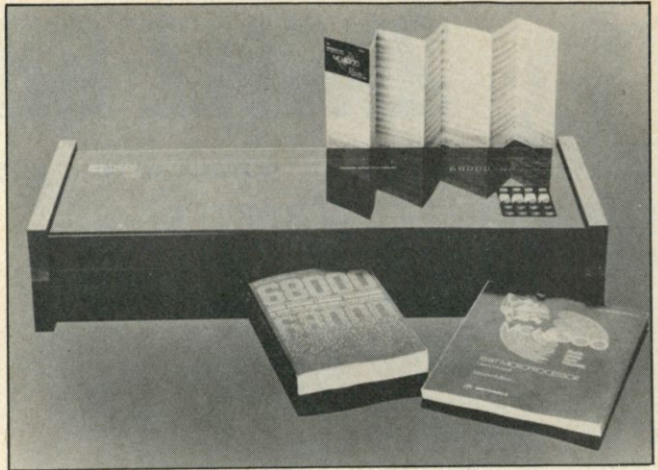

Computer System Associates' Micro 68000 trainer system.

The Micro 68000 comes with a copy of *68000 Assembly Language Programming Book* (Osborne-McGraw-Hill) and *16 Bit Microprocessor Users Manual*. Price is \$985.

Computer System Associates, Inc., 7562 Trade St., San Diego, CA 92121. Reader Service number 469.

Zenith's 8/16 Machine

A new series of desk-top computers was introduced by Zenith Data Systems, 1000 Milwaukee Ave., Glenview, IL 60025. The Z100 series in-

cludes both eight-bit and 16-bit microprocessors, a five-slot S-100 bus, 128K bytes of RAM and an integral keyboard. Eight-color graphics enhance its value as a design tool. Digital or RGB output is standard. The basic Z-100 includes one disk drive and costs \$3249. The low-profile Z-110 includes two drives and also has monochrome composite video output; price is \$3999. The Z-120 incorporates a 12-inch green phosphor screen, and costs \$4099. Zenith also offers a high-resolution RGB color monitor for \$699. Reader Service number 479.

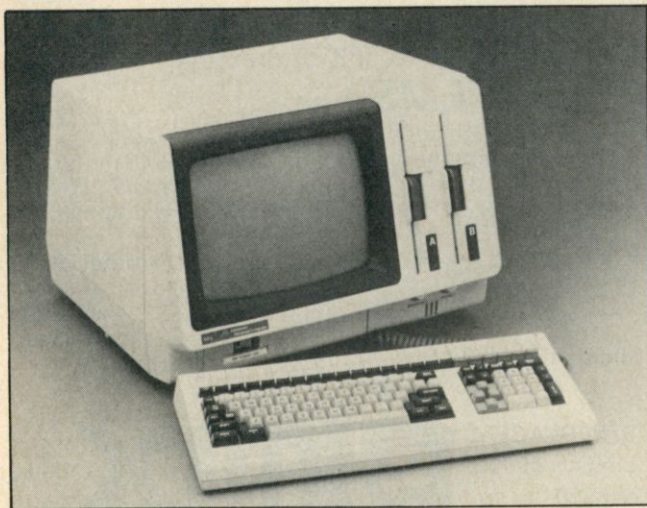

NEC Information Systems' Advanced Personal Computer.

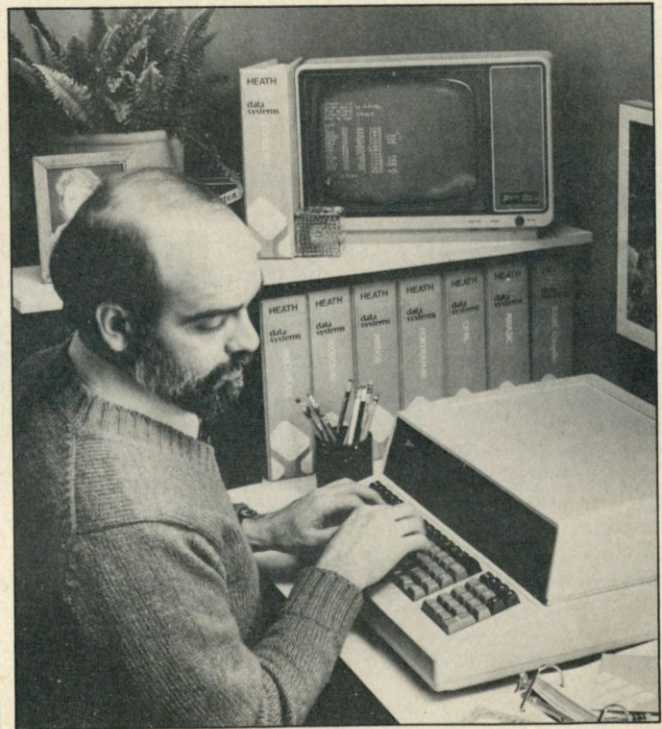

The low-profile Z100 computer from Zenith Data Systems.

WARNING!

**Electric Power Pollution.
Spikes & Lightning
HAZARDOUS to
MICROCOMPUTERS!!**

Patented ISOLATORS provide protection from . . .

- Computer errors cause by power line interference
- Computer errors due to system equipment interaction
- Spike damage caused by copier/elevator/air conditioners
- Lightning caused damage

MONEY BACK GUARANTEE!

- ISOLATOR (ISO-1) 3 Isolated 3-prong sockets; Spike Suppression; useful for small offices, laboratories, classrooms. \$69.95
- ISOLATOR (ISO-2) 2 Isolated 3-prong socket banks; (6 sockets total); Spike Suppression; useful for multiple equipment installations. \$69.95
- SUPER ISOLATOR (ISO-3) similar to ISO-1 except double isolation & oversize Spike Suppression; widely used for severe electrical noise situations such as factories or large offices. \$104.95
- SUPER ISOLATOR (ISO-11) similar to ISO-2 except double isolated socket banks & Oversize Spike Suppression; for the larger system in severe situations. \$104.95
- MAGNUM ISOLATOR (ISO-17) 4 Quad Isolated Sockets; Multiple Spike Suppressors; For ULTRA-SENSITIVE Systems in extremely Harsh environments. \$181.95
- CIRCUIT BREAKER, any model (Add-CB) Add \$9.00
- REMOTE SWITCH, any model (Add-RS) Add \$16.00

AT YOUR DEALERS

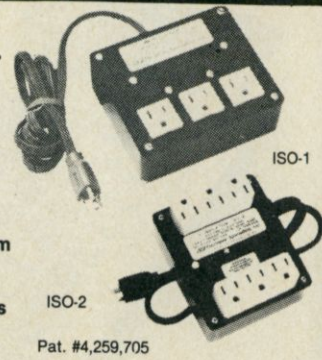

Pat. #4,259,705

ESP Electronic Specialists, Inc.

171 South Main Street, Box 389, Natick, Mass. 01760
(617) 655-1532

Parallel TTL Input IBM "SELECTRIC" PRINTER/ TYPEWRITER



Refurbished & Tested
Operational

Only
\$399

- Use as a Typewriter
- Use as a Computer Printer
- Excellent for Word Processing
- Takes Standard "Golf-Ball" Elements

This COMPLETE "Selectric" I/O Printer includes the heavy-duty, 15 character per second model 745 with 15-inch frame, plus individual Hi-Rel Solenoids for all characters & functions. The functions are decoded from 4 input data bits while characters take 6 bits plus "strobe". Since all inputs are TTL, any micro capable of 14 bits of output (Two 8 bit parallel ports) can drive the printer using a "software" driver. Or, a simple parallel or serial input may be built for the machine. Magnetic reed switches are used throughout for keyboard data as well as machine feedback for checking and time out. This is undoubtedly the BEST bargain in a typewriter/printer ever available!!! Requires 115 VAC for typewriter and 24 VDC & 5 VDC for the solenoids.

Only **\$399.00**

IBM Selectric Service Manual **\$24.00**

"Selectric" is a Registered Trademark of IBM Corp

**Computer
Products &
Peripherals
Unlimited**

WAREHOUSE
18 Granite St. Haverhill, Mass. 01830
MAIL ORDERS
Box 204, Newton, New Hampshire 03858
TELEPHONE ORDERS
617 / 372-8637
Sorry No Collect Calls
MasterCard & VISA Accepted

MOVING?

Let us know 8 weeks in advance so that you won't miss a single issue of Microcomputing

- Extend my subscription one additional year for only \$24.97.
- Payment enclosed Bill me

Canada and Mexico, \$27.97 1 year only. Foreign, \$44.97 1 year only.
U.S. Funds drawn on U.S. banks only.

Attach old label where indicated and print new address in space provided. Also include your mailing label whenever you write concerning your subscription. It helps us serve you promptly.

AFFIX LABEL

If you have no label handy, print OLD address here:

Name _____
Address _____
City _____ State _____ Zip _____

Print NEW address here:

Name _____
Address _____
City _____ State _____ Zip _____

MICROCOMPUTING

P.O. Box 997 • FARMINGDALE, N.Y. 11737

Give Your TRS-80* a Tremendous Boost with RACET COMPUTES Software

RACET COMPUTES Utility Software makes the TRS faster, more efficient, and easier to use. Our programming aids improve your productivity. Our reputation is for products that are professional in design and work as advertised!!!

FIELD PROVEN HARD DISK DRIVES AND OPERATING SYSTEM

Now you can use RACET's Hard/Soft-Disk Operating System (HSDS) with the ARM Winchester Disk Drive on the Model II. This cost effective combination provides 15 Megabytes per drive including ECC Error Correction Code and an advanced sequencer to further ensure data integrity. An incremental backup to floppy is provided so that only those sectors that were changed from the last backup are saved. A full monthly service contract is available at \$30 per month per drive.

The HSDS Software has more than One Year's FIELD Experience. The latest HSDS version adds several enhancements including maintenance of system files on the hard drive, files as large as the disk, the ability to segment the disk as logical drives, definable directory size, and many utilities including bulk copies between floppy and hard drives, multiple purge, Superzap, and Directory Catalog System. Full program compatibility with TRSDOS-2.0a is maintained. Mixed floppy and hard drive operation is supported.

HSDS is available for the Cameo, Cynthia Bull, Corvus, Data Peripherals, and Santa Clara Systems hard disk systems as well as the ARM Winchester Drive.
ARM 15 Megabyte Drive Subsystem \$3895. HSDS Software \$400.
Cameo 5/5 Cartridge Drive \$5995. Cynthia Bull 10/10 Drive \$7995

NEW PRODUCT ★ Model II Fast Backup Utility ★ \$75

5 to 10 times faster backups!!! Full disk backup (including verify) 55 seconds!!! on two drive system — 2:15 on single drive system. In business, time is money, and one BACKUP is worth 1000 tears!!

NEW PRODUCT ★ INTEGRATED BUSINESS SYSTEM ★

ISAM File Structure — Multi-Company Capability. Modular structure. Each module includes complete user documentation which guides the user through installation and allows "practice" using a sample data base. When ready, the user simply names his data base and begins. The Integrated Business System program set includes General Ledger, Accounts Receivable, Accounts Payable, Payroll, Inventory, General Journal, Asset Management and more.

Business Programs \$250/module Mod III, \$300/module Mod II, \$795 for all four Mod III, \$995 for all four Mod II. General Ledger and Accounts Receivable available now. Accounts Payable and Payroll 1st Quarter 1982.

RACET COMPUTES LTD.
1330 N. GLASSELL, SUITE M, ORANGE, CA 92667

CIRCLE READER RESPONSE BELOW FOR FREE CATALOG

CHECK, VISA, M/C, C.O.D. PURCHASE ORDER
TELEPHONE ORDERS ACCEPTED (714) 997-4950

*TRS-80 IS A REGISTERED TRADEMARK OF TANDY CORPORATION

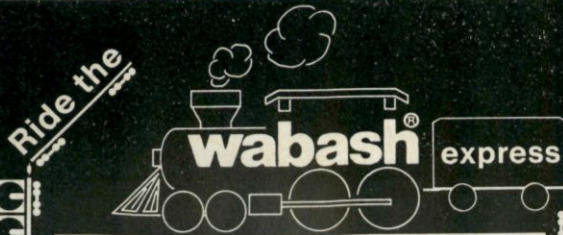

5 1/4" \$199*

SINGLE SIDE
SINGLE DENSITY
W/HUB RING
**SOFT,
10 OR 16
SECTORS**
100% CERTIFIED
2 YEAR WARRANTY

8" \$199*

SINGLE SIDE
SINGLE DENSITY
**SOFT
OR 32
SECTORS**
100% CERTIFIED
2 YEAR WARRANTY

5 1/4" \$219*

SINGLE SIDE
DOUBLE DENSITY
W/HUB RING
**SOFT,
10 OR 16
SECTORS**
100% CERTIFIED
2 YEAR WARRANTY

8" \$249*

SINGLE SIDE
DOUBLE DENSITY
**SOFT
OR 32
SECTORS**
100% CERTIFIED
2 YEAR WARRANTY

5 1/4" \$299*

DOUBLE SIDE
DOUBLE DENSITY
W/HUB RING
**SOFT,
10 OR 16
SECTORS**
100% CERTIFIED
2 YEAR WARRANTY

8" \$309*

DOUBLE SIDE
DOUBLE DENSITY
**SOFT
OR 32
SECTORS**
100% CERTIFIED
2 YEAR WARRANTY

- * • Minimum order 100 • For smaller quantities add 10%
 - Packed 10 boxes of 10 diskettes with sleeves and labels
 - Quantity discounts - 1,000 deduct 3%, 5,000 deduct 5%, 10,000 deduct 7%
 - Add \$5.00 per case 5 1/4", \$7.00 per case 8"
- For shipping and handling Continental U.S.A., U.P.S. ground.

Box of 10 diskettes: 5 1/4" 8"
OPUS ss/sd \$20 ss/sd \$21
BASF ss/dd \$23 ss/sd \$24
MAXWELL } TOO LOW TO QUOTE CALL
DYSAN }
SPECIFY SECTORING WHEN ORDERING
5 1/4" QUAD DENSITY IN STOCK

**DISK DRIVE HEAD
CLEANING KITS**
Prevent head
crashes and
ensure error-free
operation
5 1/4" or 8" \$19.50

HARDHOLE DISK PROTECTORS
Reinforcing rings
of tough mylar
protect disk hole
edge from damage.
Applicators \$3 \$4
Hardhole Rings (50) \$6 \$8

SFD C-10 CASSETTES . . 10/\$7
(All cassettes include box and labels.)
Get 8 cassettes, C-10
Sonic, and Cassette/8
Library-Album,
as illustrated,
for only \$8

LIBRARY CASES
8" Kas-sette/10 \$2.99
5 1/4" Mini Kas-sette/10 \$2.49

5 1/4" or 8"
Vinyl
Storage
Pages 10/\$5

- Written purchase orders accepted from government agencies and well rated firms at a 10% surcharge (wabash media only) for net 30 billing.
- International orders accepted with a 15.00 surcharge for handling, plus shipping charges.
- C.O.D. requires a 10% deposit.
- We accept Visa, Mastercharge, Money Orders, and Certificate checks.
- Checks require bank clearances.
- All shipments F.O.B. San Diego.
- Minimum shipping and handling 2.00, minimum order 10.00.
- California residents all 6% sales tax.
- Prices and terms subject to change without notice.
- All sales subject to availability, acceptance, and verification.
- All sales are final.
- Satisfaction guaranteed or full refund.

We also offer printer ribbons, printwheels, type elements, equipment covers, power consoles, paper supplies, storage and filing equipment, furniture and many other accessories for word and data processing systems. Write for our free catalog.

Toll Free Order Only
800-854-1555

**ABM
PRODUCTS**

For Information
or California Orders
(714) 268-3537

8868 CLAIREMONT MESA BLVD.
SAN DIEGO, CALIFORNIA 92123

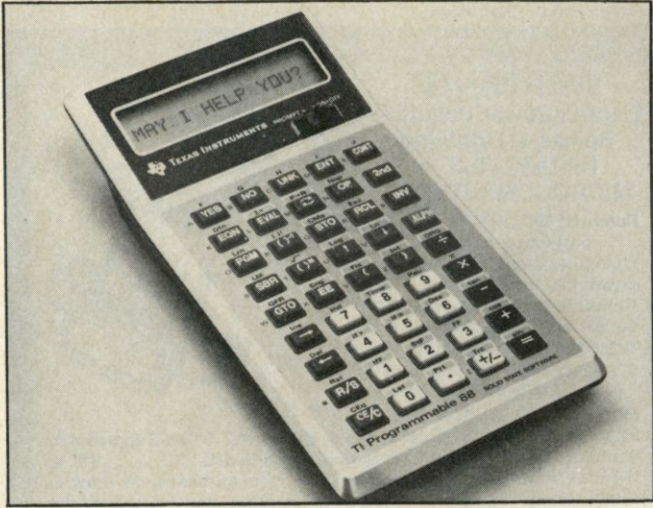

The TI-88's 16-character alphanumeric liquid crystal display represents each of 128 characters clearly and precisely.

A Sophisticated Handheld Computer

The TI-88 Programmable Calculator can be interfaced with its accessory peripherals to provide a portable computer system with nonvolatile memory features. A built-in user prompting response function helps the user work through difficult programming questions step-by-step. Numbers, upper/lowercase letters, punctuation, superscripts, common Greek letters and other special characters are represented. An enhanced algebraic operating system lets the user enter formulas as written on paper, without transposing to more intricate computer notation. Two module supports will accommodate Constant Memory modules for memory expansion or Solid State Software modules for fast access to professionally-written programs. A rechargeable battery, tone beeper and time-keeping features are incor-

porated. The TI-88 Programmable Calculator costs \$350; Constant Memory modules are \$50 each; and Solid State Software modules average \$40 each.

Texas Instruments, Inc., PO Box 10508, Lubbock, TX 79408. Reader Service number 476.

Fine-Tuned Control

Long-life linear potentiometers, selectable stick operating characteristics and styled enclosures are features of a new line of precision joysticks and paddles announced by Kraft Systems, Inc., 450 W. California Ave., PO Box 1268, Vista, CA 92083. These products are designed for plug-in compatibility with Apple II, TRS-80 and IBM Personal Computers. The joysticks feature instantly selectable spring return centering or free-floating operation, with electrical centering adjustments on each axis. Reader Service number 472.

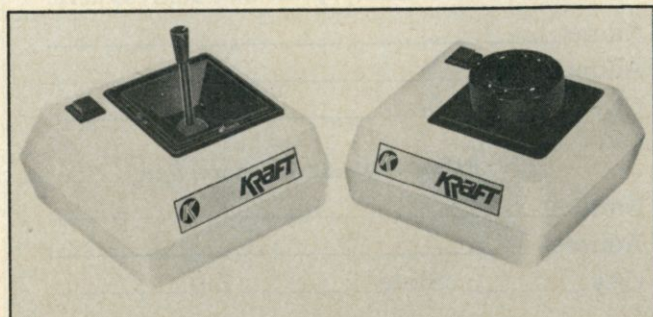

Paddles and joysticks from Kraft Systems add a new dimension of control to your Apple, TRS-80 or IBM PC.



Dynabyte's Monarch computer.

Versatile 16-Bit Box

The Dynabyte Monarch multiuser computer system offers a large selection of both eight-bit and 16-bit operating systems: Monarch supports CP/M, MP/M II, CP/M-86, MP/M-86, UNIX, Oasis-8, Oasis-16 and Business Basic. The 8 MHz 8086 and 6 MHz Z-80B support up to 16 users, allowing concurrent operation of both eight- and 16-bit software. Monarch was designed for word processing, financial modeling and other business applications—as well as networking and communications. Monarch's Model 6600 standard configuration includes 256K bytes of RAM, 19M bytes of Winchester disk storage, nine RS-232 serial ports, one RS-422 high-speed port, one parallel port and an eight-inch IBM-compatible disk drive for under \$11,000.

Dynabyte Business Computers, 521 Cottonwood

Drive, Milpitas, CA 95035. Reader Service number 480.

68000-Based Single Board Computer

The 68 Magnum 16/32-bit single board computer is offered by Intellimac, Inc., 6001 Montrose Road, Sixth Floor, Rockville, MD 20852. The 68 Magnum stand-alone computer combines the MC 68000 CPU (6 MHz version) with 128K bytes of 200 nanosecond RAM. The board features 16K bytes of operating system EPROM, 16K bytes of user EPROM, two RS-232 serial ports with selectable baud rates, a parallel port, audio cassette serial I/O port, three 16-bit programmable timers and reset and abort function switches. By adding a power supply, terminal and off-line storage device, you can create your own 16/32-bit computer system. Price is \$745. Reader Service number 481.

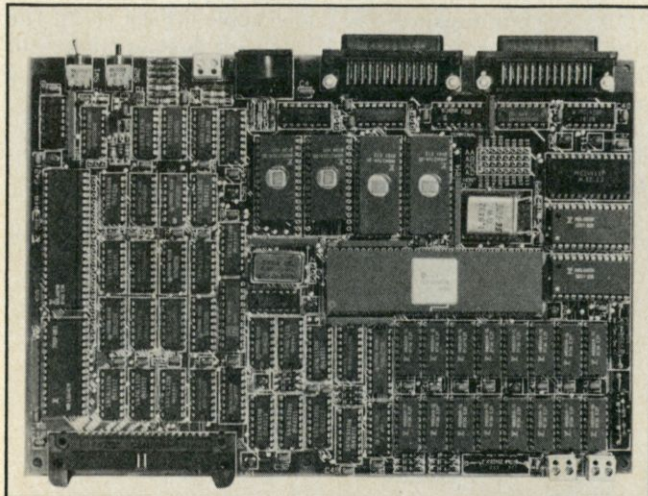

The 68 Magnum single board computer, from Intellimac, Inc.

CENTRONICS 779 / RS LINE PRINTER I

MAKE YOUR PRINTER A REAL WORKHORSE WITH OUR NEW PRINTER CONTROLLER BOARD

Remove the controller board in your printer and plug ours in to add the following capabilities:

- Bidirectional printing
- Full UPPER/lower case ASCII *plus* TRS-80 graphics or DSE scientifics character sets in 9 x 7 dot matrix format (9 x 9 available as option — requires print head change)
- Motor control — turns off the motor when the printer is not in use
- 2048 character buffer
- Software selectable features
 - transfer protocol (XON/XOFF or none)
 - character densities (10, 12, 15, 16.5 cpi *plus* double width in each size)
 - self-test
 - forms, length, control

\$350 assembled and tested

Radix Technologies

Suite 400 Carolyn Building
10400 Eaton Place
Fairfax, VA 22030

(703) 385-0900

VISA, MasterCard, check, COD accepted

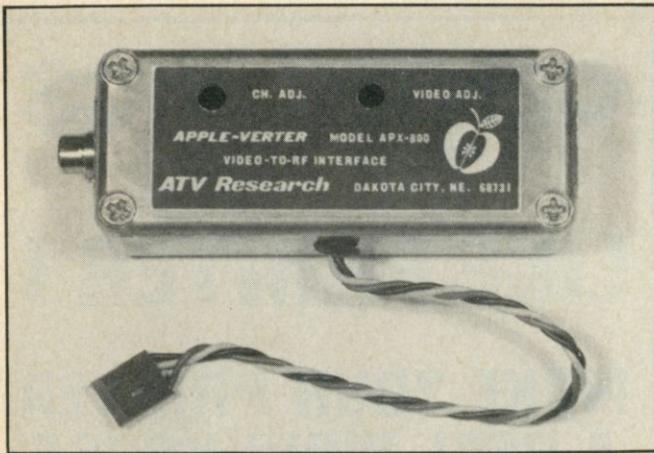

The Apple-Verter APX-800 mounts inside your Apple and plugs into your color TV.

Apple Modulator

A high-fidelity, color video modulator is available from ATV Research, 13th and Broadway, Dakota City, NE 68731. The Apple-Verter Model APX-800 is a high-VHF-band tunable modulator for the Apple II computer. It mounts inside the Apple and plugs into the existing power/video plug. A direct-connect antenna cable is supplied. By operating above normal computer harmonics, in the high-VHF band (tunable channels 7-10), the APX-800 exhibits high stability; this makes it ideal for use on non-tunable, quartz-locked TV receivers. A built-in 5 V regulator lets you

use the modulator on other computer systems with power sources anywhere from 8-24 V dc. Price is \$29.95. Reader Service number 465.

Vector Graphic Micro

The Vector 4's 8/16-bit architecture makes it an ideal system for developing sophisticated 16-bit applications, according to Vector president, Lore Harp. The computer will be available with a choice of operating systems, to provide maximum program development flexibility. The Vector 4 comes with 128K bytes of main memory, using 64K RAM chips, and is expandable



The Vector 4 8/16-bit microcomputer, from Vector Graphic.

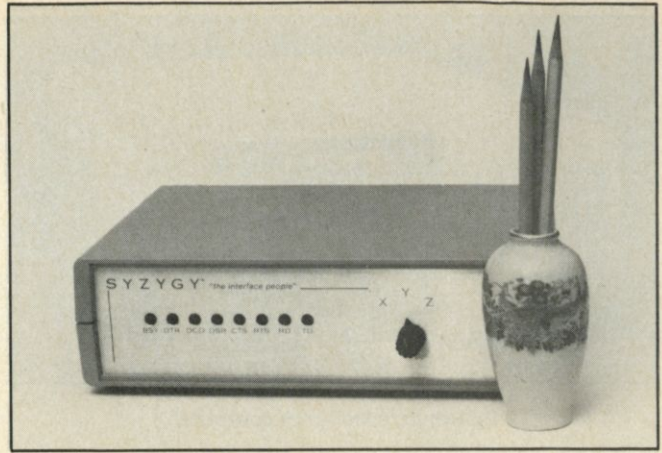

The Syzygy Serial Switchbox.

to 256K. Memory mapping logic allows the Z-80 to access the entire memory in increments as small as 2K. The Vector 4's main memory is time-shared between the CPU and video display controller. Software control of the display controller allows fast access to screen memory for high-resolution graphics, and also allows the screen memory to be moved anywhere in main memory. The Model 4/20 dual floppy disk system costs \$4495. The Model 4/30, with single floppy disk drive and Winchester 5M hard disk, costs \$5995.

Vector Graphic, Inc., 500 N. Ventu Park Road, Thousand Oaks, CA 91320. Reader Service number 478.

ly mounted ten-pole socket-mounted DIP switches allow each port to be separately configured for normal or null-modem use, and can enable, disable and jumper lines 4, 5, 6, 8 and 20. The versatile switching permits rapid configuration of the Syzygy XYZ Serial Switchbox for CRT terminals, LQ printers and CPU ports. A CPU port can select any of three different printers or terminals, or three different CPU ports can select one printer or terminal. Reader Service number 475.

Switched-On Box

An RS-232 Serial Switchbox (P/N232SB) is available from Syzygy, 256 West San Bernardino Road, Covina, CA 91723. The box measures 7 x 10 x 3 inches; it permits manual switching of a common port to any of three distribution ports. All components are solidly mounted on a 9 x 6 inch PC board. Four internal-

Apple Disk Emulator

Synetix Industries, Inc., 15050 N.E. 95th, Redmond, WA 98052, now offers a single board Solid State Disk Emulator (SSD) for the Apple II or Apple II Plus. The SSD is available in either a single disk version (147K bytes) or dual disk version (294K bytes) and plugs directly into any Apple I/O slot (1-7). The Emulator is compatible with Apple DOS 3.3, Apple Pascal and CP/M.

The single disk is \$550; the dual disk is \$950. Reader Service number 474.

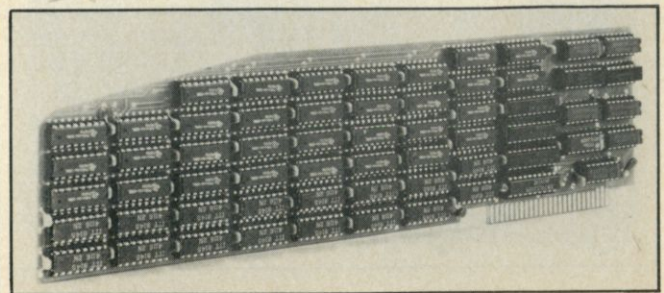

The Synetix Solid State Disk Emulator.

MICROCOMPUTING • BOOKS



THE NEW WEATHER SATELLITE HANDBOOK

BY DR. RALPH E. TAGGART

Here is the completely updated and revised edition of the best-selling **Weather Satellite Handbook**—containing all the information on the most sophisticated and effective spacecraft now in orbit. Dr. Taggart has written this book to serve both the experienced amateur satellite enthusiast and the newcomer. The book is an introduction to satellite watching, providing all the information required to construct a complete and highly effective ground station. Not just ideas, but solid hardware designs and all the instructions necessary to operate the equipment are included. For the thousands of experimenters who are operating stations, the book details all procedures necessary to modify their equipment for the new series of spacecraft. Amateur weather satellite activity represents a unique blend of interests encompassing electronics, meteorology and astronautics. Join the privileged few in watching the spectacle of earth as seen from space on your own monitoring equipment. **Order BK7383 \$8.95**

SAVE \$2.95

WEATHER SATELLITE HANDBOOK (first edition)

By Dr. Ralph E. Taggart WB8DQT. Valuable information in this first edition *is not included* in Dr. Taggart's just published book, **The New Weather Satellite Handbook** (see above). Chapters such as "How to Build an Electric Timer for Satellite Tracking" and "Building an Automatic Control for the Satellite Receiving Station" will no longer be available when this edition is out of print. This is a good entry level text for those discovering the exciting new use of weather satellites. Regular price: \$4.95. **SPECIAL PACKAGE PRICE--BOTH BOOKS FOR ONLY \$10.95, SAVE \$2.95!** (This offer available only while supplies last.) Order WS7300 and receive both editions of the Weather Satellite Handbook for only \$10.95 (plus \$1.00 shipping and handling charge).

*Use the order card in this magazine or itemize your order on a separate piece of paper and mail to: Microcomputing Book Nook • Peterborough NH 03458. Be sure to include check or detailed credit card information. Add \$1.50 first book, \$1.00 each additional book, \$10.00 per book foreign airmail. Questions regarding your order? Please write to Customer Service at the above address. Please allow 4-6 weeks for delivery. No C.O.D. orders accepted. For Toll Free ordering call 1-800-258-5473.

EPROM PROGRAMMER

Shown assembled. EPROM not included.

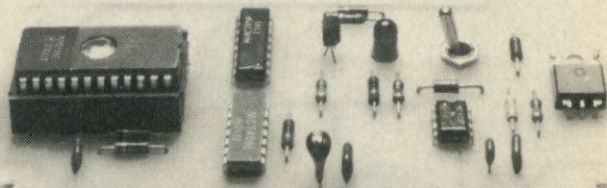

For single supply 2516, 2716 & 2758 EPROMs. Connects through a user supplied interface to any computer system. Interfacing requires two 8-bit ports plus hand-shake lines. One of the ports must be software controllable for input or output. Timing is done via hardware, thus is independent of MPU clock rate. Verify erased. Program — entire or partial. Auto verify after programming. Transfer contents to RAM for modifying or duplicating.

Select Documentation for:

6502
6800
6809
8080/8085/Z80

Interface to:

6820 PIA or 6522 VIA
6820 PIA
6820 PIA
8255 PPI

Comprehensive documentation booklet contains schematic, instructions for construction, check-out and use, and a well commented assembly listing for the specified MPU.

Complete kit of parts (includes ZIF socket) \$ 45.00

Bare PC board and Documentation \$ 25.00

Software listings for additional MPUs
(with purchase of Kit or PC board) \$ 5.00

Ordering: Specify MPU. Add 5% for P&H. Overseas add 10%. Ariz. residents add 5% tax.



Micro Technical Products, Inc.

814 W. Keating Ave., Dept. K

Mesa, Arizona 85202 • 602-839-8902



is HARD COPY STORAGE a problem?

MICROCOMPUTING, as thick as it is, is more like a floppy when it comes to standing on the bookshelf. Try the MICROCOMPUTING Library Shelf Boxes . . . sturdy corrugated white dirt-resistant cardboard boxes which will keep them from flopping around. We have self-sticking labels



for the boxes, too, not only for MICROCOMPUTING, but also for 73 Magazine, 80 MICRO . . . and for CQ, QST, Ham Radio, Personal Computing, Radio Electronics, Interface Age, and Byte. Ask for whatever stickers you want with your box order. They hold a full year of MICROCOMPUTING, 80 MICRO . . . or 73 Magazine. Your magazine library is your prime reference; keep it handy and keep it neat with these strong library shelf boxes. One box (BX-1000) is \$2.00, 2-7 boxes (BX-1001) are \$1.50 each, and eight or more boxes (BX-1002) are \$1.25 each. Be sure to specify which labels we should send. Have your credit card handy and call our toll-free order number 800-258-5473, or use the order card in the back of the magazine and mail to:

TM

MICROCOMPUTING

peterborough nh 03458

Att: Book Sales. Shipping & Handling: \$2.00 per order \$10.00 foreign airmail



Burtronix Protocard III system.

Apple III Interface

The Burtronix Protocard III is a new interface card for the Apple III computer. The card uses proven circuitry to interface a parallel interface chip to the Apple hardware bus, and lets the user put custom circuits right on the board and connect them to the Protocard's 6522 chip. Room is provided on the board for either a

26-pin ribbon connector (supplied) or a 25-pin D-type connector (also supplied) for external connections.

A software driver on disk is provided to link the Protocard III to Business Basic, Pascal or any other software that uses the SOS drivers. All communication with the Protocard III is handled by printing and reading simple strings from Pascal or Basic. Complete in-

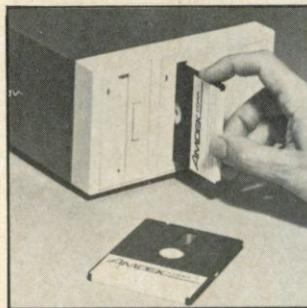

The Amdek Micro Floppydisk drive holds two three-inch cartridges.

structions are provided. Price is \$195.

Burtronix, 1667 N. O'Donnell Way, Orange, CA 92667.

Rigid Disk

The new Micro-Floppydisk dual drive from Amdek Corp., 2420 E. Oakton St., Suite E, Arlington Heights, IL 60005, offers 1M capacity and is plug-compatible with standard five-inch floppy drives. The Amdek drive has a built-in power supply and accommodates two three-inch cartridges. Cartridges, which are priced about the same as standard floppies, feature flip-top head covers that protect the disks from dust, scratches or fingerprints. The hinged cover automatically flips open when the cartridge is inserted in the drive unit. Micro-Floppydisk drive costs \$899. Reader Service number 464.

VIC-20 Expansion

The "Cardboard" is an expansion motherboard for Commodore's VIC series computers. The board has six slots that will accept any VIC-compatible cartridge in any

configuration. Blocks of memory can be switched in or out with on-board switches, as can utility ROMs and games. The Cardboard lets you increase RAM up to 40K and also use several utility ROMs. A system reset switch is included on the Cardboard, so you can restart games without turning off the computer. Units can be daisy-chained. The Cardboard costs \$119.95.

Cardeo, Inc., 3135 Bayberry St., Wichita, KS. Reader Service number 466.

S-100 Board Provides 16-Bit Capability

An 8086/8087 microprocessor board from CompuPro Systems, Oakland Airport, CA 94614, gives you the 16-bit advantage, as well as provision for adding a mathematics coprocessor and operating system firmware. The CPU 86/87 is compatible with IEEE-696/S-100 standards, and is available in either 8 or 10 MHz versions. The board accommodates both eight- and 16-bit words; its on-board logic can read or write two bytes serially for eight-bit applications, or pass word-wide values for 16-bit operation. Users can mix both types of device on one system.

CompuPro's new board accepts Intel's 8087 math processor and 80130 operating system firmware. The math processor offers high-speed number crunching, and the firmware adds an eight-level vectored interrupt controller, three interval timers, and a choice of silicon-based operating systems: the iRMX-86 kernel or CP/M-86. Price is \$695 for the 8 MHz and \$850 for the 10 MHz version. Reader Service number 468.

Circle 162 on Reader Service card.

SENECA ELECTRONICS SUPER DISCOUNTS TRS-80® AND OTHERS



TRS-80®
BELL & HOWELL™ (APPLE)™
ATARI™
VIC COMMODORE™
and OTHERS...

TRS-80™ 16K MODEL III \$810.00
TRS-80™ 64K MODEL II \$2995.00
ATARI™ 800 W/16K \$650.00
VIC-20™ HOME COMPUTER \$245.00
ALL MACHINES COME WITH FULL
MANUFACTURES WARRANTY!!

COMPUTER FURNITURE, PRINTERS, PERIPHERALS, YOU NAME IT, WE GOT IT, AT THE PRICE YOU WANT TO PAY. WE ACCEPT CERTIFIED CHECKS, MONEY ORDERS, VISA & MASTERCARD. SHIPPING CHARGES WILL BE ADDED TO CHARGE CARD ORDERS.

SENECA ELECTRONICS
RD #1, HARMONY, PA 16037
(412) 452-5654

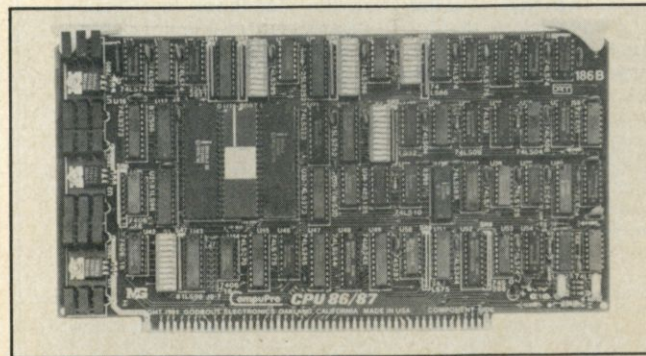

CompuPro's 8086/8087 CPU board provides 16-bit capability.

ARE YOU LOOKING FOR THE MOST RELIABLE, HIGHEST QUALITY, COMMERCIALY-BUILT PERSONAL COMPUTERS IN THE INDUSTRY?



ANNOUNCING THE ARRIVALS OF THE FUTURE- SERIES ONE AND SERIES TWO.

THE ROLLS ROYCE OF THE PERSONAL COMPUTER INDUSTRY.

- 9" or 12" CRT Display
- MTBF rated at 20,000 hours
- CP/M® operating system
- One-year warranty (first in the industry)
- 160K to 640K mini floppy disk drives

PRICES TOO GOOD TO BELIEVE.

- 9" CRT portable with two 160K, 320K, or 640K mini floppy disk drives \$2,395.00
- 12" CRT console with two 160K mini floppy disk drives \$2,895.000
- 12" CRT console with a 160K mini floppy disk drive and a 6 Megabyte Winchester disk drive \$4,795.00

A COMPANY YOU CAN DEPEND ON.

Telcon Industries has been supplying companies such as Sperry Univac, ITT, RCA, Reuters, AP and UPI, *Newsweek*, Control Data Corp. and the *Washington Post* for over a decade. We have a worldwide reputation for microcomputing, not to mention the computer that you have been looking for.



TELCON INDUSTRIES, INC. 1401 N.W. 69th STREET, FT. LAUDERDALE, FL 33309
PHONE (305) 971-2250, TWX 510-956-9412 ©CP/M is a trademark of Digital Research
OVER A DECADE IN THE TELECOMMUNICATIONS INDUSTRY.

July deliveries for console model; August deliveries for portable model. OEM SYSTEM pricing available. Distributor and dealer inquiries invited. Please call or write for catalog information.

WATCH FUTURE ADS FOR SPECIAL INTRODUCTORY OFFER!

Software for Hard Science

Several new educational packages promise to make it easier to learn chemistry. Computer Aided Instruction for General Chemistry includes from 50 to 70 drills, exercises and problems per program covering every major topic in undergraduate general chemistry. Each of the 20 programs is designed to be interactive; the student can select random subtopics, restart the program or stop at any point to load a new program. The software is available for TRS-80 Model III, Apple II and Commodore PET microcomputers.

Concentrated Chemical Concepts provides introductory chemistry for allied health students. Written for the Apple II microcomputer, this package of drill and practice exercise programs covers topics in general, organic and biological chemistry. Interactive programs include simulations, problem-solving drills, term and definition matches and a unique nomenclature drill. The package takes advantage of Apple color, graphics and sound.

Prelab Studies for General, Organic and Biological Chemistry reviews selected concepts encountered in the laboratory. Topics covered represent areas that usually require a special effort by instructors to ensure full student understanding. The program reinforces numerical and decision-making skills needed in the lab. For Apple II only.

John Wiley & Sons, Inc., 605 Third Ave., New York, NY 10158. Reader Service number 483.

Special Education

Administrative software for the special education departments of public and private

schools is being distributed by Creative Educational Service, 36 River Ave., Monmouth Beach, NJ 07750. The IEP/MS system manages "individual education programs" for handicapped students; these programs are now required by federal law. The management system leads the user through the process of preparing all necessary reports. IEP/MS is available for Apple, TRS-80 and CP/M-based microcomputers. Reader Service number 485.

The 25th Hour

A series of timesaving software for both professional and personal use is available from Softrend, Inc., PO Box 1462, Charlottesville, VA 22902. The 25:01 Time Scheduler/Organizer provides automatic scheduling of recurring activities, optional reminders for events, appointment scheduling and daily activity calendar. All entries are checked for appointment conflicts and weekend dates are flagged. The package can handle any number of people. It costs \$99.

The 25:02 Magazine/Book Reference program locates article references or other information from various journals, newspapers and books. Entries are stored and recalled by publication, author, primary and secondary topics, and key words. Price is \$69.

Each package in the series incorporates extensive screen prompting, optional use of printer, and advanced file handling techniques. They run on the IBM Personal Computer. Reader Service number 486.

SuperPilot

A versatile extension of the Apple Pilot software language has been announced by Apple Computer, Inc., 20525 Mariani Ave., Cupertino, CA

95014. SuperPilot joins several new products in Apple's series to help educators and industrial trainers create lessons and illustrations for computer-aided instruction. It features graphics enhancement, easy debugging and external video control. SuperPilot runs on an Apple II or Apple II Plus with 64K RAM. Price is \$200. Reader Service number 484.

Telecommunication Software

Two new programs have been added to the NTD-II series of traffic optimization software. These programs improve management of long distance costs by adding the Other Common Carrier (OCC) option and Exchange (NNX) analysis. The NTD-1C Toll Statement Analyzer is preprogrammed with OCC Analysis data to provide a breakdown of hours per month of WATS-eligible and OCC-eligible traffic. This program can also determine Foreign Exchange (FX) feasibility. The cost is \$1250.

The NTD-6B Multiple WATS Band Designer will configure the most complete optimization of facilities to carry a user's traffic. Options include WATS, FX, MCI, Sprint and SBS rate tables to provide optimum routing capabilities. Price is \$2300.

These programs run on the HP-85, Apple II or other CP/M-based microcomputers. For more information write to HTL Telemanagement, Ltd., 1300 Old Chain Bridge Road, Suite 5, McLean, VA 22101. Reader Service number 487.

Number Cruncher

The TK!Solver program gives professionals in engineering, business and other fields the ability to quickly and easily solve problems involving math calculations and analysis. TK!Solver appli-

cation packages contain predefined models for various fields; each model has preset equations, tables and values relevant to individual problems; the models can be modified to suit specific situations. In mechanical engineering, for instance, TK!Solver application packages can be used to solve problems of tensile and torsion stress analysis, piping layout and design, sizing of hydraulic and pneumatic actuators, beam deflection and cost efficiency. A TK!Solver model for investment management and analysis is particularly useful for calculating investment yields. And the TK!Solver program can be used for teaching any concept of high school science that involves mathematical description, whether in biology, chemistry or physics. Among the models developed for the high school science package are population growth, radioactive decay, projectile motion and chemical equilibrium. TK!Solver is currently available for the Apple and IBM Personal Computer.

Software Arts, Inc., 675 Massachusetts Ave., Cambridge, MA 02139. Reader Service number 488.

VIC-20 Quartet

Three new packages for HAMS and a fourth for file maintenance are offered by RAK Electronics, PO Box 1585, Orange Park, FL 32073. VIC File is a multipurpose file system that automatically expands available memory. Commands include Load, Save, Print, Add, Change, Sort and Delete. Requires minimum 3K expansion. Price is \$9.95.

WAS Record is an Amateur Radio program that maintains your Worked All States record for HAM Radio with a need/worked/confirmed status and the call of the station

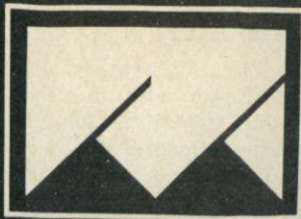

**MED
SYSTEMS
SOFTWARE**

Med Systems now offers some of the finest professional software available today. More complete information is available in our full page ads in '80 *Microcomputing*, or by calling our toll free number.

PROFESSIONAL/SCIENTIFIC WORD PROCESSING

Qwerty 3.0 offers more features than any Scripsit patch available today. Like Greek letters. Over 75 new symbols. Page end indication. Footnotes. Simultaneous superscripts and subscripts. User-controlled cursor speed. Two and three column formats. Qwerty 3.0 requires at least one disk, a TRS-80 Model I or Model III, and Scripsit. \$49.95

STATISTICAL PACKAGE FOR MICROCOMPUTERS (SPM)

SPM, written by Bruce Powel Douglass, is one of the finest statistics packages available for the TRS-80. It includes descriptive statistics, one and two way analysis of variance, single and multiple variable linear regression, and single and multiple non-linear regression. Requires a TRS-80 Model I or III with disk. \$89.95

WE GUARANTEE SATISFACTION!

When ordering, please indicate Model I or Model III, and number of disk drives in your system.

MED SYSTEMS Software
P.O. BOX 2674 CHAPEL HILL, NC 27514
1-800-334-5470

First came MICROPROOF™:

"There is simply no finer program available..."
(Creative Computing, March 1982)

Now:

**Electric
Webster
SPELLING CHECKER**

The Ultimate:

FAST—Can proof ten pages in a minute

EASY—Operates at the stroke of a key

COMPLETE—50,000 word literal dictionary

COMPACT—Fits on 5 1/4" double density disk

VERSATILE—Use with all W/P programs

CORRECTS—(Optional, add \$60.00)

AFFORDABLE—\$89.50 (TRS-80®),

\$149.50 (CP/M®)

**CORNUCOPIA
SOFTWARE, INC.**

1625 Beverly Place
Berkeley, CA 94707

Contact your local dealer, or order direct — (415) 524-8098

MICROCOMPUTING ● BOOKS

ALL NEW FOR 80 OWNERS ENCYCLOPEDIA FOR THE TRS-80*

ENCYCLOPEDIA FOR THE TRS-80** is the newest peripheral for your microcomputer. This ten-volume reference series contains programs and articles especially selected to extend the documentation that comes with the TRS-80. Volumes of the **Encyclopedia** are being issued one-at-a-time, approximately six weeks apart. This means that each new volume will reflect the latest developments in TRS-80 microcomputing. **Encyclopedia for the TRS-80** is available in two editions. The deluxe COLLECTOR'S EDITION has a handsome green and black hard cover with a dust jacket. A soft cover edition is also available.

To order single hard cover volumes of the **Encyclopedia** please specify:

Volume 1	EN8101	\$19.95*
Volume 2	EN8102	\$19.95*
Volume 3	EN8103	\$19.95*
Volume 4	EN8104	\$19.95*
Volume 5	EN8105	\$19.95*
Volume 6	EN8106	\$19.95*
Volume 7	EN8107	\$19.95*
Volume 8	EN8108	\$19.95*
Volume 9	EN8109	\$19.95*
Volume 10	EN8110	\$19.95*

To order single softcover volumes of the **Encyclopedia** please specify:

Volume 1	EN8081	\$10.95*
Volume 2	EN8082	\$10.95*
Volume 3	EN8083	\$10.95*
Volume 4	EN8084	\$10.95*
Volume 5	EN8085	\$10.95*
Volume 6	EN8086	\$10.95*
Volume 7	EN8087	\$10.95*
Volume 8	EN8088	\$10.95*
Volume 9	EN8089	\$10.95*
Volume 10	EN8090	\$10.95*

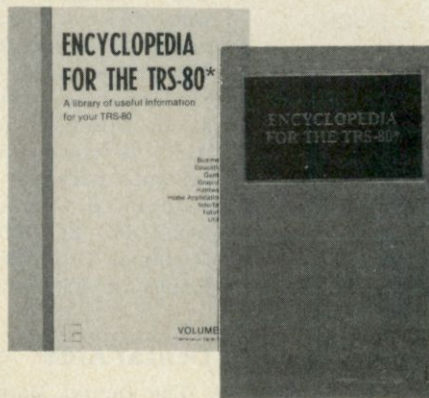

SPECIAL INTRODUCTORY OFFER

Order the entire set of the **Encyclopedia** for the TRS-80 and receive the tenth volume **FREE!**

10 Volume deluxe hard cover **COLLECTOR'S EDITION**, a \$199.50 value. **EN8100 \$164.00 postpaid**

10 Volume soft cover edition, a \$109.50 value. **EN8080 \$83.00 postpaid**

ENCYCLOPEDIA LOADER is the software companion to the **Encyclopedia** for the TRS-80. This special series of cassettes will allow you to load selected programs from the **Encyclopedia** instantly. Hours of keyboarding time and the aggravating search for typos is eliminated by using the **Encyclopedia Loader**.

Encyclopedia Loader for Volume 1 of the **Encyclopedia** of the TRS-80 is available at a **Special Introductory Price** of \$12.95 (a \$14.95 value). To take advantage of this offer specify:

EL800111 \$12.95*

Additional **Encyclopedia Loaders** will be available as each volume of the **Encyclopedia** for the TRS-80 is issued. To order specify **Encyclopedia Loader**:

Volume 2	EL8002	\$14.95*
Volume 3	EL8003	\$14.95*
Volume 4	EL8004	\$14.95*
Volume 5	EL8005	\$14.95*
Volume 6	EL8006	\$14.95*
Volume 7	EL8007	\$14.95*
Volume 8	EL8008	\$14.95*
Volume 9	EL8009	\$14.95*
Volume 10	EL8010	\$14.95*

SPECIAL OFFER

All 10 Volumes of ENCYCLOPEDIA LOADER™

A \$149.50 value for only \$119.97

EL8000 \$119.97

(shipping included)

*Use the order card in this magazine or itemize your order on a separate piece of paper and mail to **Microcomputing Book Department** ● Peterborough NH 03458. Be sure to include check or detailed credit card information. No C.O.D. orders accepted. All orders add \$1.50 for first book, \$1.00 each additional book, \$10.00 per book foreign airmail. Please allow 4-6 weeks for delivery. Questions regarding your order? Please write to Customer Service at this address.

**TRS-80 and TRSDOS are trademarks of the Radio Shack Division of Tandy Corporation.

FOR TOLL FREE ORDERING CALL 1-800-258-5473

Disk-Edit

The most powerful tool available for disk data manipulation.

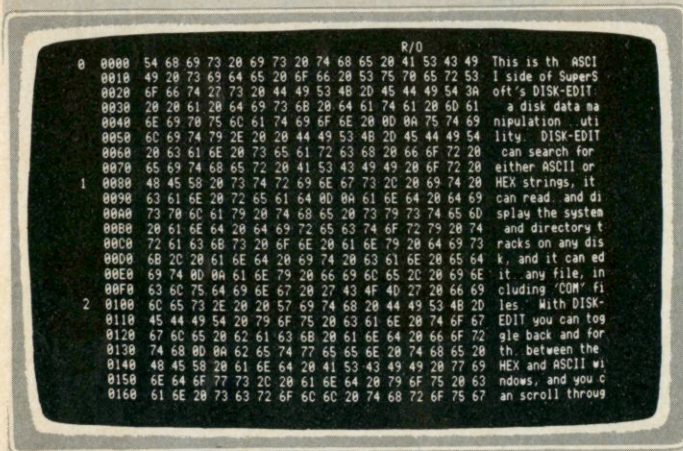

Disk-Edit provides you with ALL the raw information on your disk in both HEX and ASCII. You can scroll through that information and alter it using a set of text editing commands. You can move back and forth between HEX and ASCII windows. You can alter either the HEX or the ASCII representations of data or text. You can search for strings in either HEX or ASCII, and you have access to every bit of information on your disk.

Available for virtually all CP/M-80, CP/M-86, and IBM PC DOS compatible systems.

Disk-Edit: \$100.00
Manual Only: \$ 15.00

Japanese distribution:
ASR Corporation International 3-23-8, Nishi-Shimbashi, Minato-Ku,
Tokyo 105, Japan • Tel. (03) 437-5371 • Telex. 0242-2723
Disclaimer: CP/M is a registered trademark of Digital Research.

SuperSoft®

FIRST IN SOFTWARE TECHNOLOGY P.O. Box 1628 Champaign, IL 61820 (217) 359-2112 Telex 270365

worked for each state. WAZ Record maintains Worked All Zones records. DXCC Record maintains your DXCC Record. Each Amateur Radio program costs \$6.95. The WAS and WAZ Record programs require a 3K memory expansion; DXCC requires an 8K expansion. Reader Service number 495.

Apple Is a Learning Machine

Two programs for children are available from The Learning Company, 4370 Alpine Road, Portola Valley, CA 94025. Moptown is a set of 11 logic games; Magic Spells is a word game combining large text, color graphics and music. The programs were designed to guide children through a series of adventures that promote original thinking. There is no violence, and there are no "wrong" answers to discourage the child. Reader Service number 482.

Datacomm for Apple

"Hello Central" puts the Apple microcomputer in direct communication with other computer systems—mainframes, minis and micros. It also taps into hundreds of databases such as Dow Jones and The Source. Messages or whole files can be transferred using a text buffer with 180,000-character capacity. "Hello Central" can be used as an automatic telephone dialer to handle unattended computer hookups.

Advanced Operating Systems, 450 St. John Road, Michigan City, IN 46360. Reader Service number 494.

Dental Aide

The Dental Management System is an integrated package for the solo practitioner. The system performs billing, receivables, patient recall, insurance form preparation, management reporting and so on for over 2500 patients. Stored information is instantly accessible. The program runs on the Apple II. Price is \$1500.

SmithRick Associates, 113 Trenton Lane, Greer, SC 29651. Reader Service number 496.

Mystery Adventure For Atari

The Nightmare is an enigmatic adventure for the Atari 400/800 personal computer. Unsure whether his surroundings are "real" or merely apparent, the player finds himself trapped within a shadowy castle—the dwelling at the depths of his unconscious. As the player moves his joystick, the computer reveals (in full color graphics) the frightening and bizarre contents of the castle. The heavy iron door behind him is sealed, and only one means of escape is possible. The player must retrieve his mind's eye, lost in the tunnel of death, and return with it to the sealed door. Then and only then can he return to conscious reality. Price is \$29.95.

Epyx, PO Box 4247, Mountain View, CA 94040. Reader Service number 493.

VisiCalc File Linker

The Consolidator, from Omega MicroWare, Inc., 222 S. Riverside Plaza, Chicago, IL 60606, operates on VisiCalc files to link them together and allow manipulation of totals—without requiring the user to reenter information. For example, The Consolidator will total the results of four weekly reports to get monthly results, using only information that has already been entered and saved. The Consolidator will also print out VisiCalc commands and formulas, and the locations to which they apply. For Apple II microcomputers. Price is \$49.95. Reader Service number 492.

Apple Graphing

PFS:Graph, an easy-to-use graphics software package, is available for the Apple II. Graph is the first graphics package that can stand alone or interface directly with PFS databases or VisiCalc to produce bar, line or pie charts of presentation quality in minutes. Line and bar graphs can be mixed or matched, and up to four graphs can be displayed on a single set of axes. Bar graphs can be stacked or comparative. Other features

include automatic formatting, scaling, legend labeling and pattern fill. Graph interfaces with Silentype and Epson printers, as well as the HP 7470A plotter. Price is \$125.

Software Publishing Corp., 1901 Landings Drive, Mountain View, CA 94043. Reader Service number 491.

Type Right

A touch-typing tutorial is offered by Barron Enterprises, 714 Willow Glen Road, Santa Barbara, CA 93105. Type Right is a complete course of 22 typing programs. The beginner will find all necessary instructions displayed on the screen, but documentation is provided for the programmer who wants to make adaptations. Type Right emphasizes accuracy first, then speed. The program computes words per minute, with errors subtracted. Five games are included to keep the student's interest. Type Right runs on the Commodore PET and CBM 8032; disk/cassette available for 40-column sys-

tems—disk only for 80-column. Price is \$30.95. Reader Service number 490.

Heath Terminal Software

Generic Software, PO Box 1154, Troy, MI 48099, offers an HDOS V2.0 device driver to control data input and display for the H19 terminal. SFDVD allows H19 screen form access to user programs written in Benton-Harbor Basic, MBasic, Fortran-80 and assembly language. With SFDVD, data collection and file update systems can be easier to use. User-written applications programs need only be concerned with reading and writing data variables; SFDVD will manage all of the terminal input and data display functions. SFDVD requires an H8-H19/H89 system with 48K RAM. Price is \$19.95 at most Heathkit Electronic Centers; add \$2 for shipping/handling if ordered directly from Generic Software. Reader Service number 489.

Circle 104 on Reader Service card.

GOSUB International, Inc. presents

The **CARDBOARD** for the VIC 20! The **CARDBOARD** is an expansion motherboard for use with Commodore's VIC 20 series computers. It has six slots that will accept any VIC-compatible cartridge in any configuration.

Increase RAM up to 40K and use several utility ROMs plus have several games online, all switch selectable!

The **CARDBOARD** can be daisy-chained, giving the user an almost unlimited number of available expansion slots.

A system reset switch has also been added to the **CARDBOARD** allowing the user to select and/or restart games on ROM without turning off the computer.

All this for only \$119.95 plus \$1.50 S/H

To order send check or money order to:

GOSUB International, Inc.
501 E. Pawnee, Suite 430
Wichita, Kansas 67211
(316) 265-9858

VISA and MasterCard phone orders also accepted

Circle 103 on Reader Service card.

Dealers
SELL

Selling *Microcomputing* will make money for you. Consider the facts:
Fact #1: Selling *Microcomputing* increases store traffic—our dealers tell us that *Microcomputing* is the hottest-selling computer magazine on the newsstands.

Fact #2: There is a direct correlation between store traffic and sales—increase the number of people coming through your door and you'll increase sales.
Fact #3: Fact #1 + Fact #2 = INCREASED SALES\$, which means more money for you. And that's a fact.

For information on selling *Microcomputing*, call 800-343-0728 and speak with Ginnie Boudrieau, our bulk sales manager. Or write to her at *Microcomputing*, 80 Pine St., Peterborough, NH 03458.

MICROCOMPUTING

80 Pine Street Peterborough, NH 03458
800-343-0728

PION introduces the INTERSTELLAR DRIVE.



A solid state disk emulator for your APPLE*, TRS80, S100, or SS50 computer**

- A FAST mass storage device. Speeds up any program requiring disk access.
- No head seek time, no motor startup time, no moving parts.
- Standard 256K bytes of storage expandable to 1 megabyte.
- Independent regulated power supply.
- Automatic power failure detect and battery backup.
- Hardware error detection and write protect.
- Only 4 bytes-ports of address I/O space used
- Hardware optimized for block transfers and access.
- Drivers, diagnostics, and utilities software provided.
- Certified to comply with Class B limits Part 15 of FCC rules.

Introductory Price \$1095. plus tax and shipping

MasterCard VISA

SEND FOR FREE BROCHURE
 Identify your model.

PION, INC. Tel. (617)648-1717
74 Appleton St., Arlington, MA 02174
 *Trade Mark Apple **Trade Mark Tandy Corp.

CALENDAR

Robotics Conference

"Robot Research Developments and Applications in Canada" is the title of a conference jointly sponsored by the Central Ontario Chapter of Robotics International of Society of Manufacturing Engineers and National Research Council of Canada. This conference will be held at Delta Inn, Mississauga (Toronto), Ont. on September 20-21.

Further details of the conference can be obtained from RI-SME Conference Secretariat, 6535 Mississauga Road, Mississauga, Ont. Canada. L5N 1A6.

IEEE COMPCON Fall '82

COMPCON Fall '82, sponsored by the IEEE, will be held Sept. 20-24 at the Capital Hilton Hotel in Washington, D.C. The topic of this conference will be Computer Networks. COMPCON Fall '82 will provide the forum for the researcher, vendor, user or legislator to explore and exchange ideas on the underlying technologies, applications and public policy issues for the 80s.

For further information contact COMPCON Fall '82, PO Box 639, Silver Spring, MD 20901. 301-589-3386.

MEDcomp 82

MEDcomp 82, the medical professions computer show, will be held Sept. 23-25 at The Hilton Hotel, Philadelphia, PA.

For further information contact the IEEE Computer Society, PO Box 639, Silver Spring, MD 20901.

Fall Conference on Classroom Applications of Computers

Computer-Using Educators will hold the third annual Fall Conference on Classroom Applications of Computers in San Jose, CA, on October 1 and 2.

The schedule includes exhibits as well as workshops and six hour-long sessions covering computer-related classroom activities. Curriculum topics will include all levels of education from preschool through post-secondary.

For more information concerning membership in Computer-Using Educators or the conference write to Don McKell, Conference Coordinator, Computer-Using Educators, PO Box 18547, San Jose, CA 95158.

ACM-IEEE Fifteenth Annual Workshop on Microprogramming

The fifteenth annual workshop on microprogramming (MICRO-15) jointly sponsored by ACM, SIGMICRO and IEEE TC-MICRO will be held October 5-7, in Palo Alto, CA.

A tutorial covering current issues in firmware engineering will be presented on the preceding day, October 4, by Dr. Ted Lewis.

For more information contact Dr. Joseph Fisher, MICRO-15 Program Chairman, Yale University, Box 2158, Yale Station, New Haven, CT 06520.

NECOM '82

NECOM '82, a computer show for OEMs, sophisticated end users, dealers and distributors, will be held at the Boston Marriott Hotel, Commonwealth Ave., Newton, MA, on Oct. 12, from 1-7 P.M.

For more information contact Norm DeNardi Enterprises, 289 S. San Antonio Rd., Suite 204, Los Altos, CA 94022. 415-941-8440.

EdCom '82

The National Computer Conference and Expo for Educators will be held October 21-24 at the L.A. Convention Center, Los Angeles, CA.

EdCom '82 will feature over 200 seminars, workshops, demonstrations, exhibits, and hundreds of computers for in-depth tutorials and hands-on sessions.

Presentation topics designed for educators at all levels of expertise will include computer-aided instruction, administrative uses, classroom management, programming, research applications, authoring languages and literacy. All of these sessions will be conducted by nationally recognized professionals in the field of computer education.

For more information contact Jayne LaFountain, EdCom '82, 2629 N. Scottsdale Road, Scottsdale, AZ 85257.

Applefests

Applefest, an exposition featuring Apple and Apple-compatible products including computers, software, peripherals, accessories and publications, will be held in several different locations this fall. Applefest/Minneapolis will be held Sept. 16-19 at the Minneapolis Auditorium and Convention Hall. Applefest/Houston will be held Oct. 28-31 at the Houston Civic Center. Applefest/San Francisco will be held Nov. 18-21 at the Brooks Hall. Admission to each event is \$5.

For more information contact Northeast Expositions, 822 Boylston St., Chestnut Hill, MA 02167. 617-739-2000.

Mid-Atlantic Computer Show & Office Equipment Exposition

The Mid-Atlantic Computer Show & Office Equipment Exposition will be held Oct. 28-31 at the Armory/Starplex in Washington, D.C.

For more information contact Computer Expositions, Inc., PO Box 3315, Annapolis, MD 21403. 301-263-8044; toll-free, 1-800-368-2066.

Virginia Tech Workshops

Virginia Polytechnic Institute and State University in Blacksburg, VA, will hold two workshops on microcomputer interfacing. Personal Microcomputer Interfacing and Scientific Instrumentation Automation will be held Nov. 8-12. Microcomputer Interfacing, Design and Programming Using the Z-80/8085/8080 will be held Nov. 15-17.

For further information contact Dr. Linda Leffel, C.E.C., Virginia Tech, Blacksburg, VA 24061. 703-961-4848.

The ideal accounting package for my business would...

- 1) adapt to my method of working, not force me to adapt to its method of working.
- 2) have an alphanumeric account code that could accomodate my current structure of accounts with ease.
- 3) process accounts for [12 13] financial periods per annum.
(circle one)
- 4) be limited in the number of accounts I could put on file only by the physical storage capacity of the computer.
- 5) have a period activity volume of up to [\$1M \$10M \$100M].
(circle one)
- 6) have a year-to-date volume of up to [\$10M \$100M \$1BILLION].
(circle one)
- 7) let me custom design up to [33 66 99] reports, and not force me to make-do with just the preprogrammed reports.
(circle one)
- 8) allow me to enter next period data while in the current period without forcing an early close-out of the current period.
- 9) be expandable to include Accounts Payable, Accounts Receivable, Order Processing, Payroll, and Financial Modeling packages.
- 10) be fully guaranteed and serviced by the distributor.

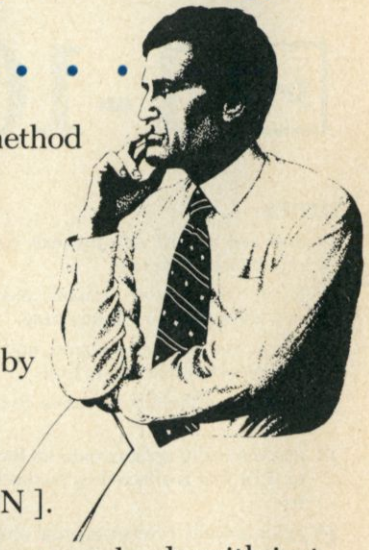

OTHER _____

(Use another sheet if necessary.)

The accounting package you've been searching for is here. Instant Software is proud to present the best accounting package on the market—
THE GENERAL LEDGER PACKAGE.

Created by The MicroComputer Business of Surry, England, The General Ledger Package is an highly comprehensive, extremely flexible, easy-to-use package designed to run on the TRS-80* Model II 64K microcomputer.

Just how good is The General Ledger Package? We're going to let you decide. Take a minute or two to decide what your electronic accounting needs are by filling out the list above, checking the appropriate boxes and circling the correct amounts. Or make your own list. Then compare your list to The General Ledger Package's list of features on the next page.

That's all. No hype. No slogans. Just the facts.

Instant Software™

Peterborough, N.H. 03458 USA A subsidiary of Wayne Green Inc.

FEATURES OF THE GENERAL LEDGER PACKAGE:

 **1-10**

OTHER:

- does not require any previous computer experience to operate.
- allows you to create, amend, and delete any account record at any time.
- allows you to create, amend, and delete any report on file at any time.
- gives you instantaneous access to the files.
- automatically updates data on the Master File that is affected by transaction entry.
- automatically reverses accrual entries made in previous period.
- has built-in batch and run controls.
- prints hard copy log after every entry that can affect a file.
- has an automatic peripheral device check which tells you if a problem exists and where it lies.
- comes complete with Master Disk for your files, ready-to-run disk, and blank disk.
- screen layouts are clean, attractive and informative.
- accompanies all transactions with an audit trail.
- Transaction File has assigned-by-you reference #s.
- Transaction Listings can be listed sequentially or under variety of criteria selected by you.

*TRS-80 is a trademark of Tandy Corp.

- 64 combinations of inquiry options to Transaction File.
- can print reports at any one of nine levels of detail that you select.
- ignores invalid data, making unwanted or accidental entry impossible.
- can run on floppy disk or a hard drive disk.
- has extraordinary documentation that includes screen photos for every program.
- has utility programs which simplify computer housekeeping tasks.
- file recovery system normally repairs scrambled files and recovers data.
- will not let you duplicate account numbers.
- maintains details of activities period by period so that comparisons are easily obtained.
- does not permit access or entry while the program is operating.

Now, if you have something on your list that you don't see on ours, chances are The General Ledger Package has it or can do it. We just don't have enough space to list every feature the package offers. At a list price of \$897, you won't find a better bookkeeper who'll work for less.

To order your General Ledger Package, simply fill in the coupon below and send it to Instant Software, Attn: John Gancarz, 80 Pine Street, Peterborough, NH 03458. If you'd like to know more about The General Ledger Package, call toll free 1-800-258-5473 and ask for our free brochure. Or write to Sandra Merchant, Technical Service Advisor at the above address.

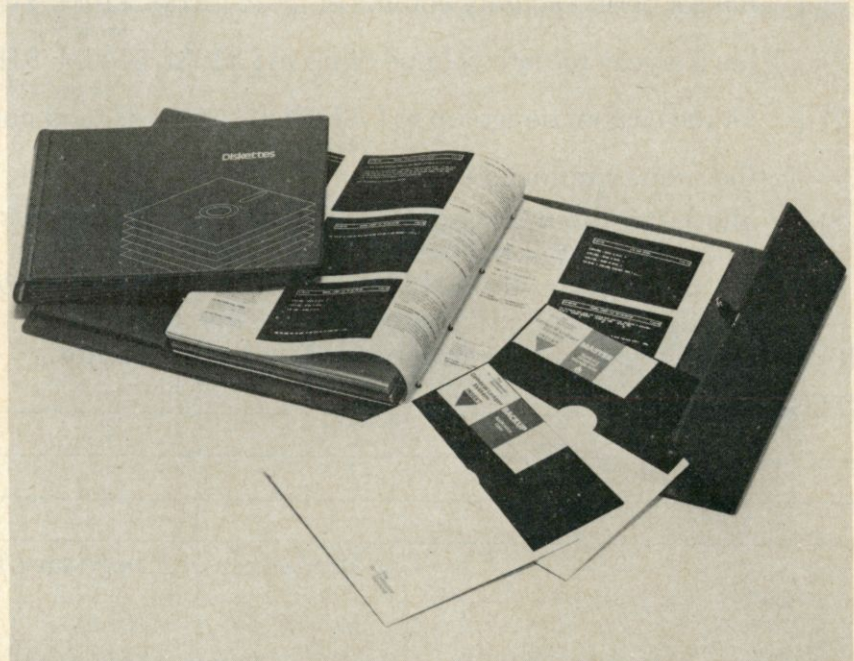

YES, I want THE GENERAL LEDGER PACKAGE for my business.

Please send me _____ packages @ \$897.00 for a total of \$ _____
 _____MC _____VISA _____AMEX _____MO _____Certified check

Interbank # _____ Exp. date _____

Signature _____

NAME _____

POSITION _____

COMPANY NAME _____

ADDRESS _____

CITY _____ STATE _____ ZIP _____

TELEPHONE _____

98

Instant Software™

Peterborough, N.H. 03458 USA A subsidiary of Wayne Green Inc.

REVIEWS

(from page 162)

- Automatic single, double spacing.
- Automatic press-return-to-continue message. You set the maximum number of lines to be presented on the screen. This feature prevents long messages from scrolling out of sight.
- Automatic insertion of up to nine different variables in the text with an imbedded code.

Manual

The 52-page manual discusses the operation of these functions in detail. An Applesoft programmer should have no trouble using the enhancements, no matter what his level of expertise.

It includes examples, giving you not only a thorough understanding of the functions, but also a head start in finding applications for them. The examples are repeated on the disk, so you don't have to code them yourself.

Conclusion

You can, of course, fake all these enhancements without using Apple Spice. But that takes extra coding and slows down execution of the program. I found Apple Spice to be a worthwhile addition to Applesoft—one that will make future programming projects much easier and more satisfying.

Probably the best thing about Apple Spice is the fact that these utilities are loaded in machine language from the disk to your Apple's memory, and are made a part of the program you are developing. If you are developing a program for sale, you are only asked to credit the manufacturer on screen (in the format shown in the manual), to send two copies of the program to the manufacturer, and to not include instructions for using Apple Spice in the package you sell. Since the buyer doesn't need that information anyway, it sounds fair enough. Apple Spice sells for \$29.95.

(Adventure International, PO Box 3435, Longwood, FL 32750.)

David Goodfellow
Seattle, WA

VisiDex

Remembers and retrieves
Items of interest
Easily and promptly

VisiCorp's (formerly Personal Software) VisiDex is difficult to categorize. It is not a son of VisiCalc. I would rather borrow a term from psychology, and call the pro-

gram a free-floating database.

VisiCorp is careful in attaching a label. It says that VisiDex is a computerized index card (true), and lists 101 ways in which it can be used. VisiDex is a difficult program to master, but worth the effort for those willing to spend a few hours learning all the intricacies.

As a database, each record consists of one Apple screen of up to 20 lines or a maximum of 799 characters. The amount of data that can be put on one disk depends on the length of each record. The program tells you—whenever you load the data screen—of the available space, which starts with a maximum of about 131,000 characters. It is unlikely that you will run out of space on any one disk, since you will soon find out that it is desirable to separate different kinds of data on different disks.

There are no fields, as in ordinary databases. Instead, you enter whatever information you care to in a variety of ways on one 40-character by 20-line screen. This is then saved as one record.

Data can be entered from the keyboard in normal uppercase, in inverse video or as flashing characters. The latter two are especially useful when printing out information, since the program asks whether or not inverse (or flashing) characters should be printed. In this manner you can have data on your screen for informational purposes which will not be printed on your address labels, for instance. According to the manual, it is possible to use lowercase with all common L.C. adapters. I was not able to get my computer into lowercase mode. The shift key modification is probably needed for that, although the manual does not mention it.

Instead of fields, you use keywords. A

```
*****
*ORDER NO:      6245      *
*VENDOR        ROBERST CORP. *
*CUSTOMER      PAY MORE  *
*ORDER DATE    3-12-81   *
*DEL. DATE     7-15-81   *
*              *
*ITEM          120 # 104 PENCILS *
*              120 # 106 PENS  *
*****
```

Fig. 1. Sample set of purchase orders with VisiDex.

```
*****
*ORDER NO:      *
*VENDOR        *
*CUSTOMER      *
*ORDER DATE    *
*DEL. DATE     *
*              *
*ITEM          *
*              *
*****
```

Fig. 2. "Orders" template.

record can be cross-indexed with up to 32 six-character words. Even more keywords can be used if the words are shorter. In retrieving information, a keyword will quickly get you the screen or screens you want. An imaginative use of the ampersand (&) in finding information makes it possible to obtain any data previously put on a record. With or without a keyword, the program will search out a word or number added after the & symbol and retrieve the record. When using the & symbol, retrieval just takes longer. Don't start a keyword with a space, or you won't be able to retrieve it. Fig. 1 shows a single example of a set of purchase orders.

The keyword is Orders. Unless you want to cross-reference, it is advisable not to have more than one keyword per record. If you have a long list of orders with different vendors, but want to see only those from the Roberst Corp., search for Orders&Roberst or &Roberst. A list of all Roberst purchase orders will appear.

Practically any kind of printout format can be designed easily and quickly within the limits of the 40 by 20 format. An elegant and convenient way to do this is with the /KE command, plus the # symbol in front of a keyword. #Keyword puts you in the design-a-template mode. Fig. 2 is an example of the template for the "Orders" form of Fig. 1.

After you design the template and recall it with its keyword, data can be entered for each record, even by an inexperienced operator. After saving the record on disk, the next blank template appears automatically with an audible beep.

A calendar function is available for reminders of appointments or important dates of any kind. A reminder screen will appear up to 14 days ahead when the data diskette is loaded. Any record can have a calendar function. You can add an audible alarm to the calendar function if you have a clock card. I did not test it, since I don't have one.

Documentation is well-written and consists of a table of contents, 162 pages of instructions and an alphabetical index. Read the instructions, follow the 94 pages of tutorial with hands on your computer, and you will have an idea of VisiDex. Many hours of experimentation will still be required to operate the program properly. I think once it is mastered you will like it.

VisiDex is designed to work with one disk drive. A second drive adds little to its versatility, except for the ability to read and write text files. This can only be done with two disk drives.

You might think that VisiDex was designed with the idea of selling floppy disks. The program works beautifully as long as you plan the collecting of your data well in advance and keep dissimilar data on separate disks. For instance, don't mix your names-and-addresses with purchase orders, supplies or an index of books or records. If you do, and then try

FOR TRS-80 MODEL I OR III IBM PERSONAL COMPUTER

- ★ **MORE SPEED**
10-20 times faster than interpreted BASIC.
- ★ **MORE ROOM**
Very compact compiled code plus VIRTUAL MEMORY makes your RAM act larger. Variable number of block buffers. 31-char-unique wordnames use only 4 bytes in header!
- ★ **MORE INSTRUCTIONS**
Add YOUR commands to its 79-STANDARD-plus instruction set!
Far more complete than most Forths: single & double precision, arrays, string-handling, clock, graphics (IBM low-res. gives B/W and 16 color or 200 tint color display).
- ★ **MORE EASE**
Excellent full-screen Editor, structured & modular programming.
Word search utility
THE NOTEPAD letter writer
Optimized for your TRS-80 or IBM with keyboard repeats, upper/lower case display driver, full ASCII.
- ★ **MORE POWER**
Forth operating system
Concurrent Interpreter AND Compiler
VIRTUAL I/O for video and printer, disk and tape (10-Megabyte hard disk available)
Full 8080 or 8088 Assembler aboard
(Z80 Assembler also available for TRS-80)
Intermix 35- to 80-track disk drives
IBM can read, write and run M.3 Disks
M.3 can read, write and run M.1 disks

MMS FORTH

THE PROFESSIONAL FORTH SYSTEM FOR TRS-80 & IBM PC

(Thousands of systems in use)

MMSFORTH Disk System (requires 1 disk drive, 32K RAM)
V2.0 Radio Shack TRS-80 Model I or III \$129.95*
V2.1 IBM Personal Computer (80-col. screen) \$249.95*

AND MMS GIVES IT PROFESSIONAL SUPPORT

Source code provided
MMSFORTH Newsletter
Many demo programs aboard
MMSFORTH User Groups
Inexpensive upgrades to latest version
Programming staff can provide advice, modifications and custom programs, to fit YOUR needs.

MMSFORTH UTILITIES DISKETTE: includes FLOATING POINT MATH (BASIC ROM routines plus Complex numbers, Rectangular-Polar coordinate conversions, Degrees mode, more); plus (TRS-80) a powerful CROSS-REFERENCER to list Forth words by block and line; plus (TRS-80) a full Forth-style Z80 assembler (requires MMSFORTH V2.0, 1 drive & 32K RAM) \$39.95*

FORTHCOM: communications package provides RS-232 driver, dumb terminal mode, transfer of FORTH blocks, and host mode to operate a remote FORTHCOM systems (requires MMSFORTH V2.0, 1 drive & 32K RAM) \$39.95*

THE DATAHANDLER: a very fast database management system operable by non-programmers (requires MMSFORTH V2.0, 1 drive & 32K RAM) \$59.95*

FORTHWRITE: fast, powerful Word Processor w/easy keystrokes, Help screens, manual & demo files. Full proportional w/rits, outdenting. Include other blocks, documents & keyboard inputs— ideal for form letters (requires MMSFORTH V2.0, 2 drives & 48K RAM) \$175.00*

MMSFORTH GAMES DISKETTE: real-time graphics & board games w/source code. Includes BREAKFORTH, CRASH-FORTH, CRYPTOQUOTE, FREEWAY (TRS-80), OTHELLO & TICTACFORTH (requires MMSFORTH V2.0, 1 drive & 32K RAM) \$39.95*

Other MMSFORTH products under development

FORTH BOOKS AVAILABLE

MMSFORTH USERS MANUAL - w/o Appendices \$17.50*
STARTING FORTH - best! \$15.95*
THREADED INTERPRETIVE LANGUAGES - advanced, analysis of FORTH Internals \$18.95*
PROGRAM DESIGN & CONSTRUCTION - Intro. to structured programming, good for Forth \$16.00*
FORTH -79 STANDARD MANUAL - official reference to 79-STANDARD word set, etc. \$13.95*
FORTH SPECIAL ISSUE, BYTE Magazine (Aug. 1980) - A collector's item for Forth users and beginners \$4.00*

* - ORDERING INFORMATION: Software prices include manuals and require signing of a single computer license for one-person support. Describe your Hardware. Add \$2.00 S/H plus \$3.00 per MMSFORTH and \$1.00 per additional book. Mass. orders add 5% tax. Foreign orders add 20% UPS COD. VISA and M/C accepted; no unpaid purchase orders or refunds

Send SASE for free MMSFORTH information
Good dealers sought

Get MMSFORTH products from your
computer dealer or

**MILLER MICROCOMPUTER
SERVICES (M9)**

61 Lake Shore Road, Natick, MA 01760
(617) 653-6136

to print an alphabetical listing of addresses and telephone numbers, you will get your titles of books and/or records, supplies and purchase orders mixed in.

The reason for this is a curious lack of choice in commands. When you choose to print, you can sort or select a keyword, but not both. When you print with the sort command, every screen of your disk will be printed in alphabetical or numerical order, once for each keyword. That is why I suggested above that you use one keyword per record only, unless you want to cross-index. The lack of more than one keyword can be overcome by the use of the ampersand (&) function.

When sorting numerically, the program first looks at the first digit of your number. For example, 3, 125, 19, 8, 235 will be printed in the order 125, 19, 235, 3, 8. To get the order right you have to enter the above numbers as 003, 125, 019, 008, 235. This will make the program sort them correctly. The documentation does not explain this. I found out the hard way.

VisiDex is a versatile program that will remember innumerable items of interest and retrieve them easily and promptly. It is not the speediest program around, since information is recalled from the disk. When entering data you won't have to worry about a power outage. Each screen is saved on disk before the next one can be entered. The only data you could lose would be the one being worked on.

VisiDex will remind you of appointments and important dates during the current year as well as those in the future. Although the price (\$200) is a bit high, it can and should be used as a database where mostly reminding and collecting and retrieval of simple information are required.

VisiDex requires Apple II or II+ with 48K, one disk drive, 3.3 DOS, a monitor or TV and preferably a printer.

(VisiCorp, 2895 Zanker Road, San Jose, CA 95134.)

**G.R. Brieger
Redmond, WA**

P-Lisp

The first Lisp Interpreter for The Apple II

Little is known about Lisp in the world of microcomputers. This otherwise convenient language for artificial intelligence has so far failed to gain much attention in this field, primarily because it uses memory in megabytes.

P-Lisp is beginning to change all that, especially for Apple II owners. The P in P-Lisp stands for the company where Steven Cherry developed the language, Pegasys Systems Co., Inc., of Philadelphia.

Like most of the Lisps on the market for

micros, P-Lisp is an interpreter. Like your basic interpreter, it reads and interprets each expression you type as soon as you press enter. P-Lisp was the first Lisp interpreter designed especially for the Apple II.

I wish I could say that Lisp is easy to learn and that anyone can just sit down and master it. However, if you have never tried programming in APL, Pascal or Basic, many of the concepts in Lisp will take some getting used to.

The lists which are processed in Lisp are similar to string arrays in Basic. In Lisp, however, any element of a list can be a list, and any element of that list can be a list, etc. This is a characteristic of Lisp which allows you to conveniently associate information—such as associating the color "red" with the attribute "color" for the object "ball." Ball could also have other attributes that could be as specific as "manufacturer," with which the name "Spaulding" could be associated.

Aside from lists, Lisp processes "atoms." Atoms are similar to variable names in Basic, but they can be any length in P-Lisp and up to about 30 characters in other interpreters. Atoms can also be function names, like print in Basic. Function names can be defined in Lisp (as they can in APL, for example). Functions can also call themselves, an act called recursion, which repeats the function the same way a goto to a previous line in a Basic program would.

In Lisp, however, when a function is called by itself, all values of all variables are saved at their current value before the function is executed again. This feature of recursion makes all previous values of the variables available when you return to that state of the function (the state before it was called). Basic destroys the value of the variables each time they are used in a function.

Another useful feature of Lisp is that variables can be localized as in APL functions. This means that you can use a handy variable name in more than one function. Without altering its value in any other function, you can call one function in which the variable name appears.

To associate attributes with objects in Basic, I would set up an attribute array:

DIM BLS(n,2) where "n" is the number of attributes the ball will have, such as size, hardness, color and manufacturer.

I would then assign "color" and "red" to the same value of "n" in BLS:

BLS(1,1) = "COLOR"

BLS(1,2) = "RED"

So far, so good. In Basic, I must know in advance that I am going to have attributes, and that there are going to be no more than a certain number of them (up to "n").

In P-Lisp I do not need to know in advance that an object will have attributes. At any time in the program the association can be accomplished by typing:

(PUT 'BALL 'COLOR 'RED)

The real advantage of Lisp is in recall. If I want to know what color the ball is, all my program has to say is (GET 'BALL 'COLOR)

Imagine the for-next loop in Basic, searching through the values of BL\$(n,1) for a match and then printing BLS(n,2). (Do not try to imagine the Basic program for processing attributes for a list of objects, please.)

Because a lot of this kind of searching is done in artificial intelligence, Lisp has functions like put and get which are built into it. Incredibly, at least one implementation of Lisp for micros has omitted these key associative functions. Another, not for Apple, does not provide a printer output function.

More Than a Toy

The sheer size of memory required is one of the main reasons why artificial intelligence experts tend to dismiss the micro Lisps as toys having limited usefulness.

The sample Eliza program that Gnosis gives away with the purchase of P-Lisp does not seem to suffer much from the memory limitations. It carries on a spirited conversation that offers little evidence of being generated by a toy.

The key to learning Lisp is not in the size of the programs you write but in the knowledge of the behavior of Lisp's functions. It seems to me that the value of the implementations of Lisp for microcomputers is that they make the language accessible for so much less money than the larger machines.

In P-Lisp most of the functions of mainframe Lisp are implemented as built-ins; this means they are available whenever you load Lisp from disk.

A minor shortcoming which results from the lack of memory space in microcomputers is the limited number of times a function can call itself. In P-Lisp, space for the recursion stack can be increased at the expense of program or data space (allowing for more recursions). In most cases, except for mathematical calculations (not a Lisp forte, in any case), P-Lisp's default setting—which allows 128 recursions—is perfectly adequate.

Learning to Lisp with P-Lisp

P-Lisp provides excellent documentation. This is particularly welcome since offerings for the microcomputer—particularly from younger firms—often neglect the documentation area. Gnosis supplies an excellent tutorial and a complete, clear user manual.

This tutorial consists of a ring binder full of short, easy-to-digest chapters, and a disk file, called "book," which has examples referred to in the text and a number of useful help functions.

Appropriate quotations at the beginning of each chapter set the easy-going tone for the tutorial. The frequent puns

FREE

with software purchase—
One CPM Handbook

FREE WITH EVERY WORDSTAR—MICROPRO WORDSTAR TRAINING GUIDE

DISCOUNT SOFTWARE

Ad#27

ULTIMATE SOFTWARE PLAN

We'll match any advertised price on any item that we carry. And if you find a lower price on what you bought within 30 days of buying it, just show us the ad and we'll refund the difference. It's that simple.

Combine our price protection with the availability of full professional support and our automatic update service and you have the Ultimate Software Plan. It's a convenient, uncomplicated, logical way to get your software.

✓ (New items or new prices)

CP/M users:
specify disk systems and formats. Most formats available.

CP/M®	DISK WITH MANUAL ONLY	MANUAL ONLY
ARTIFICIAL INTELLIGENCE*		
Medical(PAS-3)	\$849/\$40	
Dental(PAS-3)	\$849/\$40	
ASYST DESIGN*/FRONTIER		
Prof Time Accounting	\$549/\$40	
General Subroutine	\$269/\$40	
Application Utilities	\$439/\$40	
COMPUTER PATHWAYS*		
Pearl (level 1)	\$ 99/\$25	
Pearl (level 2)	\$299/\$40	
Pearl (level 3)	\$549/\$50	
DIGITAL RESEARCH*		
CP/M 2.2		
NorthStar	\$149/\$25	
TRS-80 Model II (P+T)	\$159/\$35	
Micropolis	\$169/\$25	
PL/I-80	\$459/\$35	
BT-80	\$179/\$30	
Mac	\$ 85/\$15	
Sid	\$ 65/\$15	
Z-Sid	\$ 90/\$15	
Tex	\$ 90/\$15	
DeSpool	\$ 50/\$10	
CB-80	\$459/\$35	
CBasic-2	\$ 98/\$20	
FOX & GELLER		
✓ Quickscreen	\$135/\$na	
✓ Quickcode	\$265/\$na	
✓ dutil	\$ 65/\$na	
GRAHAM-DORIAN*		
General Ledger	\$729/\$40	
Acct Receivable	\$729/\$40	
Acct Payable	\$729/\$40	
Job Costing	\$729/\$40	
Payroll II	\$729/\$40	
Inventory II	\$729/\$40	
Payroll	\$493/\$40	
Inventory	\$493/\$40	
Cash Register	\$493/\$40	
Apartment Mgt	\$493/\$40	
MICRO-AP*		
S-Basic	\$269/\$25	
Selector IV	\$295/\$35	
Selector V	\$495/\$50	
MICRO DATA BASE SYSTEMS*		
HDBS	\$269/\$35	
MDBS	\$795/\$40	
DRS or QRS or RTL	\$269/\$10	
MDBS PKG	\$1295/\$60	
MICROPRO*		
WordStar	\$319/\$60	
Customization Notes	\$429/\$na	
Mail-Merge	\$109/\$25	
WordStar/Mail-Merge	\$419/\$85	
DataStar	\$249/\$60	
WordMaster	\$119/\$40	
SuperSort I	\$199/\$40	
Spell Star	\$175/\$40	
CalcStar	\$259/\$na	
MICROSOFT*		
Basic-80	\$298	
Basic Compiler	\$329	
Fortran-80	\$349	
Cobol-80	\$629	
M-Sort	\$175	
Macro-80	\$144	
Edit-80	\$ 84	
MuSimp/MuMath	\$224	
MuLisp-80	\$174	
Multi Plan	Call	
Manager Series	Call	
ORGANIC SOFTWARE*		
TextWriter III	\$111/\$25	
DateBook II	\$269/\$25	
Milestone	\$269/\$30	
OSBORNE*		
General Ledger	\$ 59/\$20	
Acct Rec/Acct Pay	\$ 59/\$20	
Payroll w/Cost	\$ 59/\$20	
All 3	\$129/\$60	
All 3 + CBASIC-2	\$199/\$75	
Enhanced Osborne	\$269/\$60	
PEACHTREE*		
General Ledger	\$399/\$40	
Acct Receivable	\$399/\$40	
Acct Payable	\$399/\$40	
Payroll	\$399/\$40	
Inventory	\$399/\$40	
Surveyor	\$399/\$40	
Property Mgt	\$799/\$40	
CPA Client Write-up	\$799/\$40	
P5 Version	Add \$129	
MagiCalc	\$269/\$25	
✓ "Peach Pak" Series 4	\$1195/\$na less 10%	
STAR COMPUTER SYSTEMS		
G/L, A/R, A/P, Pay	\$ 359	
All 4	\$1129	
Legal Time & Billing	\$ 849	
Property Mngmt.	\$ 849	
STRUCTURED SYSTEMS*		
Business Packages, Call for Price		
SORCIM*		
SuperCalc	\$269/\$na	
Trans 86	\$115	
Act	\$157	
SUPERSOFT*		
✓ Ada	\$224/\$na	
Diagnostic I	\$ 49/\$20	
Diagnostic II	\$ 84/\$20	
Disk Doctor	\$ 84/\$20	
Forth (8080 or Z80)	\$149/\$30	
Fortran	\$219/\$30	
Fortran w/Ratfor	\$289/\$35	
C Compiler	\$174/\$20	
Star Edit	\$189/\$30	
✓ Scratch pad	\$174/\$15	
✓ Statsgraph	\$174/\$15	
✓ Dataview	\$174/\$20	
Other	less 10%	
SYSTEMS PLUS		
✓ 1 Module	\$425/\$na	
✓ 4 Modules	\$1395/\$na	
✓ All 8	\$3400/\$na	
TCS*		
GL or AR or AP or Pay.	\$ 79/\$25	
All 4	\$269/\$99	
Compiled each	\$ 99/\$25	
Inventory	\$ 99/\$25	
UNICORN*		
Mince	\$149/\$25	
Scribble	\$149/\$25	
Both	\$249/\$50	
WHITESMITHS*		
"C" Compiler	\$600/\$30	
Pascal (incl "C")	\$850/\$45	
"PASCAL"		
Pascal/MT+ Pkg	\$429/\$30	
Compiler	\$315	
Sp Prog	\$175	
Pascal/Z	\$349/\$30	
Pascal/UCSD 4.0	\$670/\$50	
Pascal/M	\$355/\$20	
"DATA BASE"		
FMS-80	\$649/\$45	
dBASE II	\$595/\$50	
Condor II	\$899/\$50	
"WORD PROCESSING"		
WordSearch	\$179/\$50	
SpellGuard	\$229/\$25	
VTS/80	\$259/\$65	
Magic Wand	\$289/\$45	
Magic Spell	\$269/\$25	
Spell Binder	\$349/\$45	
Select	\$495/\$na	

APPLE II®

INFO UNLIMITED*

EasyWriter (Prof) \$159

Datadex \$129

EasyMailer (Prof) \$129

Other less 15%

MICROSOFT*

Softcard (Z-80 CP/M) \$298

Fortran \$179

Cobol \$499

Tasc \$139

MICROPRO*

Wordstar \$269

MailMerge \$ 99

Wordstar/MailMerge \$349

SuperSort I \$159

Spellstar \$129

PERSONAL SOFTWARE/ VISCORP*

Visicalc 3.3 \$199

Desktop/Plan II \$199

Visiterm \$ 90

Visidex \$199

Visiplot \$180

Visitrend/Visiplot \$259

Visifile \$169

✓ Visischedule \$259

PEACHTREE*

G/L, A/R, A/P, Pay or Inventory (each) \$224/\$40

✓ Peach Pack \$795

✓ Systems Plus, Accounting Plus II, G/L, AR, AP, or Inventory (each) \$385/\$na (Needs G/L to run)

"OTHER GOODIES"

Micro Courier \$219

Super-Text II \$127

Data Factory \$134

DB Master \$184

16-BIT SOFTWARE

8086 SOFTWARE

✓ Supercalc \$269

✓ Wordstar (ISMPC) \$289/\$na

Call for others

CALL TOLL FREE VISA • MASTERCARD

U.S. 1-800-421-4003 • CALIF. 1-800-252-4092 • LOS ANGELES 1-213-837-5141

Outside Continental U.S.—add \$10 plus Air Parcel Post • Add \$3.50 postage and handling per each item

* California residents add 6% sales tax • Allow 2 weeks on checks, C.O.D. \$3.00 extra • Prices subject to change without notice. All items subject to availability • ®—Mfgs. Trademark. Blue Label \$3.00 additional per item.

THE DISCOUNT SOFTWARE GROUP

6520 Selma Ave. Suite 309 • Los Angeles, Ca. 90028 • (213) 837-5141

Int'l TELEX 499-0446 DISCSOFT LSA • USA TELEX 194-634 (Attn: 499-0446)

TWX 910-321-3597 (Attn: 499-0446)

keep the reader from getting bored.

The user manual is written on a professional level with a complete listing of the built-in functions which shows schematically what arguments each requires.

The written material is under constant review. The fact that the sheets are punched allows Gnosis to frequently add corrections.

Conclusion

From a technical standpoint P-Lisp is the best fit for the Apple II. Because it was designed for the machine, many Apple II commands—including graphics commands—are directly available in P-Lisp.

Also, no extra circuit boards are required. Other implementations of Lisp which run on the Apple require either UCSD Pascal (card or disk), or a Z-80 card.

The best way to look at P-Lisp is as a trainer or tutorial for the larger, compiled versions of Lisp. After all, who wants to sit at the console of a half-million dollar mainframe and enter a Lisp program full of beginner's errors?

The combination of its technical fitness for the Apple II and the excellent tutorial documentation makes the P-Lisp interpreter the best in its class.

(*Gnosis, 4005 Chestnut St., Philadelphia, PA 19104.*)

**Max A. Lebow
Philadelphia, PA**

QuickTrace

A relocatable machine Language program for The Apple II

Assembly- and machine-language programmers often need the capability for slowing program execution to facilitate following the sequence of instructions executed. Older mainframe computers provided switches which allowed the user to start and stop program execution, execute instructions one at a time, or change the contents of the program counter or a memory location. These features were included when the first microcomputers were introduced.

The designers of the Apple II computer, however, like several other microcomputer developers, eliminated these features. As a consolation, the old monitor ROMs of the Apple II contain routines which allow single stepping through machine-language code. This is the step command which decodes and displays each instruction in disassembled form, executes the instruction, and then displays the contents of the internal registers of the 6502.

A similar command, trace, will step through instructions continuously until a BRK instruction is encountered or the reset button is pressed.

Both commands are helpful in debug-

ing machine-language code; however, their usefulness is very limited, and there are many instances in which they cannot be used. For example, since the disassembled instructions and register contents are displayed on the active output device (usually the CRT), it is not possible to observe the output generated by the program while simultaneously tracing the execution of programs which produce graphics displays. Also, if a program changes the output hooks which point to the output device handler, it is possible to lose trace information. Fi-

Commercially-available
programs rarely provide
the features I
expect to find. . . .
QuickTrace exceeded
my expectations.

nally, the machine-language step and trace commands were not included in the new autostart monitor ROMs of the Apple II Plus.

To overcome these deficiencies, Aurora Systems has introduced the program QuickTrace, written by John Rogers. QuickTrace is a relocatable machine-language program which provides extremely versatile single-step and trace execution of programs.

Three modes of operation are available: single-step, trace and background. The first two are enhanced versions of the Apple step and trace commands; the third, background mode, permits tracing with no output until a user-defined stop condition is met, at which time execution is returned to single-step mode.

This background mode is useful for fast execution of debugged routines or monitor routines while retaining single-step tracing of other program segments. Switching between modes is permitted and simply requires pressing ESC to return to single-step mode and then "T" or "B" for trace or background modes.

During single-step or trace modes the four lower lines of the display device are usually used to show the tracing information. The user can determine how much of this information is to be displayed and whether output is to the CRT or to a printer. The display of information to the CRT can be suppressed so conflict with the graphics or text output of a traced program is avoided.

Tracing information includes a disassembled display of the last instruction executed and the next instruction to be executed, the contents of the 6502 registers, the top six values on the system

stack and the stack pointer.

The actual data address referenced by each instruction is displayed along with the contents of that location whether addressing is by a direct, indirect or relative addressing mode. In addition, the contents of several user-definable locations may be displayed at each step.

Six commands are available. They provide the conditions under which execution in the trace and background modes are halted. These conditions include stopping if: a given address is referenced; a referenced address lies within a given range; the accumulator, X register or Y register contains a specified value; a user-defined location contains a certain value; or a specified opcode is encountered.

Commercially-available programs rarely provide all the features that I expect to find in professional works. QuickTrace, however, exceeded my expectations for a trace routine for the Apple II. Since obtaining QuickTrace, I have used it to debug several of my own programs and to help understand the operation of several others.

I have found it relatively easy to use: although knowledge of 6502 machine language is, of course, important for its use. I am finding this program to be an invaluable aid for debugging machine-language code. I recommend its use to assembly-language programmers at all levels of expertise.

(*Aurora Systems, Inc., 37 S. Mitchell, Arlington Heights, IL 60005. \$50.*)

**Larry Gonzalez
Chicago, IL**

Catalog V4.12

A disk cataloging program That lists, sorts and reports On database entries

The Scene

Six different programmers have been working on four different CP/M-based microcomputer development systems (MDSs) for over three years. In addition to the desired results, the programmers were left with several undesirable by-products: over two hundred floppy disks containing bits and pieces of programs, data and texts documenting them. Add to the confusion the fact that two of the original programmers have gone, and are no longer available to help sort out what they have left behind. And one of these programmers had the nasty habit of labeling all experimental programs X.ASM or QQ.FOR.

The Cleanup

After a couple of years of experimentation, the project had settled down to the point where it was necessary to weed out all the unneeded disks, programs, etc.

What could be safely discarded? It was

Sales Opportunity

A few select territories available

Join a fast growing company involved in the microcomputer industry as a direct salesman. Sales involve our wide selection of books, four publications and software. We are looking for a non-smoking individual with a good sales background and a basic understanding of microcomputers. An excellent career awaits the person who wants to be "on his own." It will be the responsibility of our direct salesman to become familiar with all makes of computers and their sales outlets, amateur radio and electronic stores, book stores, and other outlets for our products in your given territory. We will also add other lines as they become available. Arrangements are being made to coordinate efforts with some other firms in the

area, including a major printer manufacturer. We offer an excellent growth potential with a highly motivated, young corporation. If you or someone you know is interested in the opportunities available at Wayne Green Inc., please submit your background in detail, including sales experience, recent work history, knowledge of the microcomputing industry, educational background and references to:

Sales Manager
Wayne Green, Inc.
Peterborough, NH 03458

All replies will be immediately acknowledged and held in the strictest of confidence.

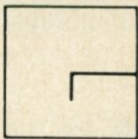

WAYNE GREEN, INC.
(M-9) Pine Street
Peterborough, N.H. 03458

Circle 45 on Reader Service card.

PLAY THE NUMBERS GAME — AND WIN

With **ELF** and **TWG/ARIMA** STATISTICAL SOFTWARE

TWG/ARIMA

is invaluable to users interested in time series. This Box-Jenkins package identifies

- seasonal and non-seasonal differencing
- Box-Cox transformations estimates
- correlation between coefficients
- Box-Pierce Q statistics and their significance
- t statistics
- probabilities and predicts
- various lead times
- starting points
- confidence levels for time series forecast data

ELF performs

- factor analysis
- multiple regression
- stepwise discriminant analysis
- cross tabulations
- 1 and 2 way ANOVA

as well as all basic statistics, including skewness, kurtosis, etc. and Chi-Square. ELF will also create and edit a data base as well as visually depict data in scattergrams and histograms (bar graphs) and more

\$200.00

\$300.00

Each program comes with database manager, numeric software keypad and requires an Apple II with Applesoft, 48 K, and DOS 3.3

To order write to
The Winchendon Group
3907 Lakota Road
P.O. Box 10114K
Alexandria, VA 22310

(703) 960-2587

Mastercard/VISA

THE WINCHENDON GROUP

Circle 292 on Reader Service card.

COOSOL COMPUTER PRODUCTS

PRINTERS



- EPSON MX70 \$288
- EPSON MX80 GRAFTRAX+ CALL
- EPSON MX80 F/T GRAFTRAX+ CALL
- EPSON MX100 GRAFTRAX+ CALL
- NEC PC-8023A-C CALL
- NEC 3550 CALL
- NEC 3510, 3515, 3530 \$1695
- NEC 7710, 7715, 7730 \$2275
- NEC 7720, 7725 \$2645
- C.I.TOH 8510AP \$499 • 8510ACD \$616
- C.I.TOH 1541SP \$769 • 1541SRE \$839
- C.I.TOH F10-40PU \$1395 • F10-40RU \$1495
- OKIDATA 82A CALL • 83A CALL
- OKIDATA 84A CALL • 82A TRACTOR \$60
- TALLY MT 1602 MT 1605 \$1495
- TALLY MT 1802 MT 1805 \$1795
- DIABLO 630R132 \$2395 • 630R101 \$1749
- DIABLO 630R104 \$2395 • 630K104 \$2949
- QUME SPRINT 5 45/RO,KSR & 55/RO,KSR CALL
- ANADEX ADX-9500-P ADX-950-P \$1295
- SMITH-CORONA TP-1 CALL

HAYES SMART MODEM & CHRONOGRAPH

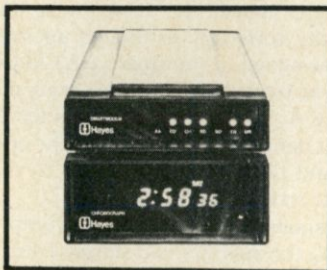

- HAYES SMARTMODEM \$229
- RS-232C COMPATIBLE
- FULL and HALF-DUPLEX OPERATION WITH BOTH
- TOUCH TONE and PULSE DIALOG
- AUTO-ANSWER/DIAL/REPEAT
- COMPLETELY PROGRAMMABLE
- BUILT-IN AUTO MONITOR
- STATUS AT A GLANCE
- DIRECT-CONNECT DESIGN
- HAYES CHRONOGRAPH \$209
- NOVATION AUTO-CAT AUTO ANS \$219

Monitors

- NEC JC-1202DH RGB HIGH RES. COLOR \$799
- AMDEK COLOR-II RGB HIGH RES. COLOR \$769
- NEC PC-1201(M/A) HIGH RES. GREEN \$179

Terminals

- TELEVIDEO 910 \$595, • 912 \$705
- TELEVIDEO 920 \$750, • 950 \$959
- ADDS Viewpoint A1, A2, A3, \$535

NEC COMPUTER



- Above NEC System with PC-8001A CPU/KBD, PC-8012A I/O Exp., PC-8031A Dual Disk, & JB-1201 Green Monitor \$2149
- NEC ACCESSORIES & SOFTWARE CALL

Other Computers

- ALTOS 8000 SERIES COMPUTERS CALL
- ALTOS 5-15D \$2299
- ALTOS 5-5D, SOFTWARE and etc CALL
- ATARI 800 48K, and 810 \$1249
- ATARI PERIPHERALS and SOFTWARE CALL
- DYNABYTE 5605-6-1 \$5999
- DYNABYTE OTHER SYSTEMS CALL
- SANYO MBC-1000 \$1639
- SANYO MBC-2000 \$2899
- SANYO MBC-3000 \$4999
- ADD-ON DISK DRIVES CALL
- SOFTWARE for the above CALL

Calif. (714) 545-2216

(800) 854-8498

COOSOL, INC. P.O. BOX 743, ANAHEIM, CALIFORNIA 92805-0743

necessary to retain at least one copy of all the preliminary programs, just in case. But with too many duplicate names of too many partially debugged programs on too many disks with too little supporting documentation, the cleanup was not easy.

Enter Catalog V4.12

With the arrival of the disk cataloging program from SRX Systems, the cleanup took only a couple of days. First, all the old disks were cataloged without any attempt at a preliminary cleanup.

Then the entire catalog was listed. Duplicate copies of programs were instantly visible, as were those instances of program fragments hiding under undecipherable names. These identifications were made easy because Catalog not only

lists all programs and each disk on which they are found, but also sorts them by size, recognizing size differences of as little as 128 bytes.

What Catalog Does

Each disk to be cataloged is assigned a number between one and 255. This disk ID can be typed in by the operator, or made hard by a directory entry on the disk. In either case, Catalog reads the disk directory and creates a database entry for each file named in the directory. In addition to the file name, the file size is stored in the database. Files with the same name, but with sizes differing by as little as 128 bytes, will be cataloged as separate entries.

Each database entry, therefore, identifies a file by name and size, and includes a list of each disk on which that file can be found. For users of CP/M versions 2 and higher, Catalog also keeps track of user number and read/write (R/W) protection status of each file.

After the database entries have been created, comments can be added by the operator, further identifying each disk and file in the database.

With all the disks entered into the database, Catalog can then display reports in several formats on the console, or print them out on the list device, under operator control. The reports can include all of the information in the database, or selected subsets of disk or file listings.

Operating Catalog

The 18-page manual supplied by SRX Systems can be digested in a couple of minutes, and operation of the program can then begin. In the example situation described above, the disks were first manually sorted by estimated age, and each assigned a number. CATALOG.COM was then copied onto an empty disk in drive A: When loaded, it asks for the current data. This is entered by the operator, and the program is ready to read disks or write reports.

In response to the program's prompt of Catalog, the operator can simply enter B: and a carriage return if the disk to be cataloged in drive B has a valid disk number in its directory. If not, the operator can enter B:57, for example, and the disk will be assigned the ID of 57; however, a hard ID will not be created in that disk's directory. That task is left to the operator.

Almost faster than you can notice, Catalog will have read the directory track from the disk in drive B, and will begin sorting the data into a database file on drive A. While this is happening, the operator can remove the disk from drive B, and have another inserted by the time Catalog is done writing the data file. A whole stack of disks can be read into the database in a few minutes.

Generating Reports

With all the disks entered into the data-

base, the operator can then extract the desired information.

After entering the current date, the operator enters DISKS to get a listing of all the disks in the database. The report lists each disk in the database by number, the total file contents in K bytes, the disk's last update date and the comments assigned to each disk. Catalog even throws in a total of all the files on all the disks.

Any subset of disks can be reported, by entering DISKS 10-23 (to list disks 10 through 23 inclusive) or DISKS 15- (to list all disks from 15 up) or DISKS-12 (to list disks 1 through 12). Disks as cataloged do not need to have contiguous numbering. Unassigned numbers will not be shown by DISKS.

Finding Files Using Wildcards

Catalog V4.12 includes a database search routine that is even more powerful than the CP/M convention wildcards. If the operator enters FIND MON, the program searches for all occurrences of file names that include the characters MON in any position within the file name. This comes in handy when you can't remember exactly what you called a file, but do recall at least a sub-string within the file name.

List a Single Disk

When entering a single disk number, the disk is identified, along with all the files on the disk. You can inspect the directory of any of your disks at any time without having to put them in a drive. And you get more than a simple directory listing, since the comments assigned to the disk and all its files are also included.

List All Your Files

The database created by Catalog is a quick and powerful reference. The entire database can also be listed to the console or printer by using the wildcard extension*.*

The Source

Catalog V4.12 is available on single density IBM format eight-inch floppy disks. You might want to check with SRX Systems as to current format availabilities and pricing.

Addendum

The program is available in standard eight-inch, Micropolis Mod I, Micropolis Mod II and North Star double-density formats.

SRX advises that they will make a reasonable effort to furnish the program on other formats and invite inquiries.

(SRX Systems, 2812 Westberry Drive San Jose, CA 95132, \$75.)

Ken Barbier
Borrego Springs, CA
Addendum furnished by
Steven Guralnick
Daly City, CA

Circle 63 on Reader Service card.

D/Punch?

HOW WOULD YOU LIKE A 500% RETURN ON INVESTMENT IN 10 MINUTES? IN ACTUALITY, YOUR ROI INCREASES EACH TIME YOU USE D/PUNCH. D/PUNCH IS SPECIALLY ENGINEERED TO MAKE IT EASY FOR YOU TO PUNCH A CUTOUT ON YOUR FLOPPY DISKS—THEREBY ALLOWING YOU TO WRITE (SAVE) ONTO THE OTHER SIDE. WHEN YOU SEND US YOUR ORDER, BE SURE TO TELL US YOUR SYSTEM CONFIGURATION.

a) D/PUNCH	6.95
b) LABELS (100)	3.00
c) WRITE-PROTECT STICKERS (105)	2.65
d) DISK SAVER 5 1/4"	10.99
e) DISK SAVER RINGS (50)	5.25

ADD: \$2.00 FOR SHIPPING & HANDLING.
MA RESIDENTS ADD 5% TAX.
SEND CHECK OR MONEY ORDER TO:

D/Punch Co.
P.O. BOX 201
NEWTON HIGHLANDS, MA 02161
(617)964-2126

ALLOW 4-6 WEEKS FOR DELIVERY.

Circle 305 on Reader Service card.

28K

Commodore VIC Computer
(60% more powerful than VIC-20)

\$299

Special Sale Price

We add 60% more programming power to the VIC-20 computer! This gives you a full sized extra featured computer with 20,000 bytes ROM, 16K extended level II BASIC 8000 bytes RAM, that expands to 60K total memory! 66 typewriter keyboard, graphics keep, 16 color s, sound, music, real time, upper lower case, full screen editing, \$109 modem, printer, disks, cassette plug in direct! We have over 400 programs! 90 day immediate replacement warrant! On day express mail delivery!—write for free catalog.

15 Day Free Trial—
Immediate Refunds

PROTECTO ENTERPRIZES
Box 550 Barrington, IL 60010
Phone Orders 312/382-5244

IBM PERSONAL COMPUTER USERS

COMPLETE YOUR REFERENCE LIBRARY

Que On Systems

IBM's PERSONAL COMPUTER

Que Corporation's new 300 page book, IBM's PERSONAL COMPUTER describes the hardware, peripherals and IBM's program library. Whether you are an IBM Personal Computer user or prospective buyer, you will discover the significance of IBM's new product to your personal or business applications.

...at computer stores and fine book stores \$14.95



and...

PERSONAL COMPUTER AGE

The Definitive Journal For The IBM Personal Computer User

Keeps you updated monthly with the latest news and applications for your IBM Personal Computer. Featuring: Hardware and Software Reviews — New Product Announcements — Technical Articles — Problem Reporting — Vendor Directory — Classified Ads — Special Interest Columns.

\$18.00/YR.
(12 issues)

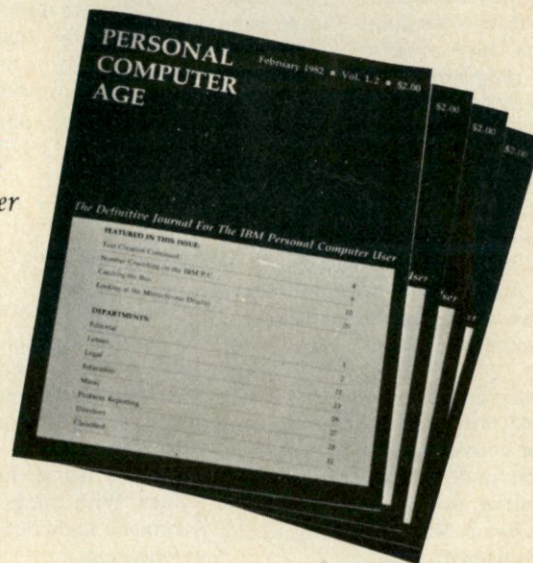

BOTH FOR ONLY \$22.95

PERSONAL COMPUTER AGE

For Credit Card Orders, Dial Toll Free
(800) 227-2634 ext. 936
In California
(800) 772-2666 ext.936

- I Want Everything — PERSONAL COMPUTER AGE and IBM's PERSONAL COMPUTER for \$22.95
- NEW RENEWAL
- Send the Book only for \$14.95
- Just enter my subscription to PERSONAL COMPUTER AGE for \$18.00
- Payment Enclosed

Charge my: VISA MASTER CHARGE

Card # _____

Expiration Date: _____

Authorized Signature _____

Name _____

Address _____

City _____

State _____ Zip _____

PERSONAL COMPUTER AGE P.O. BOX 70725 Pasadena, California 91107 Dept. K1

Spice Up Your Applesoft VisiSeries Introduces an Index First Apple Lisp Interpreter A Better Debugging Aid Disk Cleanup Is a Snap

Apple Spice

Enhances Applesoft
And makes programming
Easier and more satisfying

Applesoft is a good, no-nonsense, floating-point version of Basic for your Apple II—but it has its weak points. Apple Spice strengthens three areas of Applesoft to make the programmer's life easier. It adds print using, string search and if-then-else to the Applesoft vocabulary.

In addition, it contains an extended input package and a screen output package, which enhance input and output with wraparound (no more broken words) and other features which will be discussed later. By a strange coincidence, these additions address the only major weaknesses I am aware of in Applesoft.

Apple Spice comes on a DOS 3.2 disk (unprotected) with the invitation to back it up and/or convert to DOS 3.3. Its routines may be made a part of any program you are writing, so you will not have to run Apple Spice before running a program which uses it.

Print Using

Rounding off numbers on screen or paper requires (for me, at least) the subroutine listed below. This must be called whenever a variable must be printed.

```
500 REM***ROUNDOFF***
510 N=2: S=7
520 XS="" +STR$(INT
(X*10^N+.5))
530 Q=LEN(XS)-(VAL(XS)<0)
540 PRINT SPC
(S-Q*(Q>N+1)-(N+2)*
(Q<=N+1));
550 PRINT MID$(XS,1+(VAL
(XS)<0),
(Q<=N)+(Q-N)*(Q>N));
560 PRINT MIDS
("0.00",1+((N+1)<Q),
1+(N-Q+2)*(Q<N+2));
570 PRINT RIGHT$(XS,^(Q>N)
```

```
+ (Q - 1) * (Q <= N));
580 X = 0
590 RETURN
```

Formatting text is even worse because each case is different and a subroutine simply doesn't do the job. It gets really complicated when a rounded-off number must follow a string variable—then both techniques have to be used.

A routine that prints a billing total based on time and rate, using standard Applesoft, would go something like this:

```
600 WIDE = 85: X = HO * RA
610 FOR I = 1 TO WIDE - 65: PRINT
"";:
NEXT I: PRINT HO; " HOURS
AT "; RA; " = " : FOR I = 1 TO
WIDE - (71 - (LEN (STR$(HO)))):
PRINT " " : NEXT I: PRINT "S":
GOSUB 500
```

In this example, HO is the total hours, RA is the rate and X is the total charge (multiply HO times RA). This is the number that the subroutine at line 500 rounds off.

Print using does away with all that fuss. With the help of Apple Spice I can replace lines 500 through 610 with the following:

```
600 HTAB 5: PRINT HO " HOURS AT
$"; RA; " = " : & PRINT
"$####.##", HO * RA
```

Sure makes life easy, doesn't it? Print using allows you to print numeric values in a specified format. The "#" reserves space for a numeral; those that are not used become leading spaces. The command supports commas, floating dollar signs and asterisk fill, and has an overflow indicator.

String Search

String search in Applesoft is slow, slow, slow! String search in Apple Spice is fast, fast, fast! You don't need the Applesoft MIDS function to search a string for another string imbedded in it. This does away with tedious coding and slow searching.

One of the nice things about this func-

tion is that you can search a user's input for key words. If a key word is found, the computer makes one response; if no key word is found, the computer makes a different response. This makes dialogue between the Apple and its user fast, simple and almost human.

If-Then-Else

The if-then command is a powerful one, and is frequently used in most Applesoft programs. But it only covers one side of the coin. If the expression is true, the command is carried out, as are subsequent commands or expressions on the line. But if the expression is false, nothing is done. The computer simply goes on to the next line of the program ignoring everything on the line that contained the if-then. Life would be easier if it were possible to perform some positive action when the if-then is false.

If-then-else makes it possible.

Extended Input Package

The extended input package makes entering data from the keyboard easier to control. It includes the following:

- Word wrap. Words which do not fit on one line are moved down, rather than split.
 - Maximum string length. This feature rejects all input exceeding a string length that you have defined.
 - Control character filter. All control characters are ignored on input.
 - Selective character filter. You may select up to 20 characters which will be replaced by spaces on input.
- These features take a great deal of drudgery out of coding.

Screen Output Package

The Screen Output Package means just that—it works only on the screen, not on the printer. It includes the following features:

- Word wraparound—no more broken words.

(continued on page 155)

The Apple Polisher

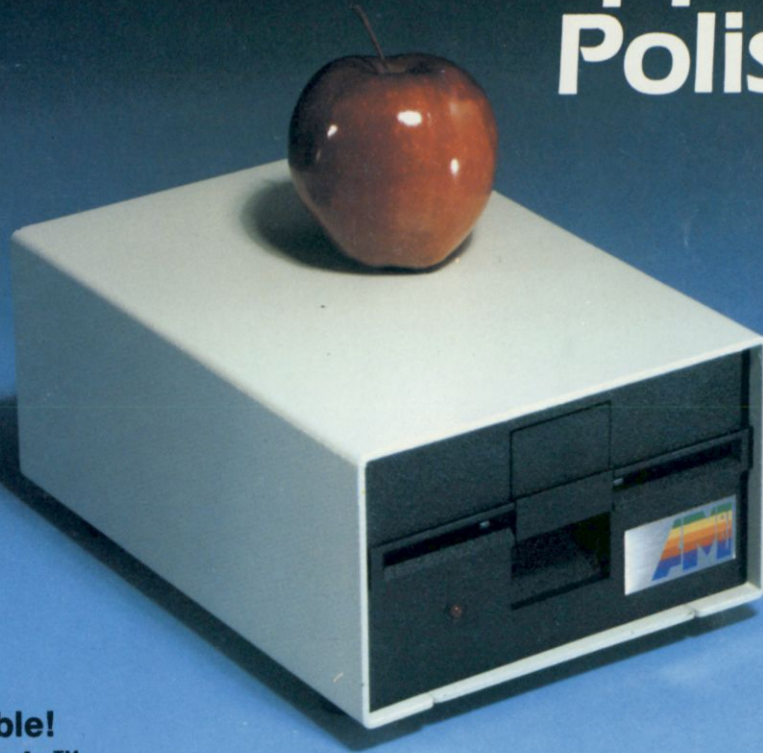

Now Available!
The new Apple™—
compatible disk drive
from A. M. Electronics

The wait is over.

Now you can get an affordable, high-performance, 5¼-inch disk drive that is fully compatible with your Apple computer.

Our drive comes complete with an Apple-beige case and connecting cables. This drive has been fully tested with Apple's

disk operating system and software. Just plug it in — it's ready to run.

You get a 90-day limited warranty and a 10-day money back guarantee.

This Apple-compatible drive is available now from A.M. Electronics for just \$395.00 (40-track) or \$495 (80-track).

Today, upgrade your Apple computer with an A.M. Electronics disk drive — and go to the head of your class!

The power behind
the drive!



A.M. ELECTRONICS, INC.

3446 Washtenaw Avenue • Ann Arbor, MI 48104 • 313/973-2312

™ Apple Computer Corp.

Circle 55 on Reader Service card.



REMEMBER:

Circle 355 on Reader Service card.

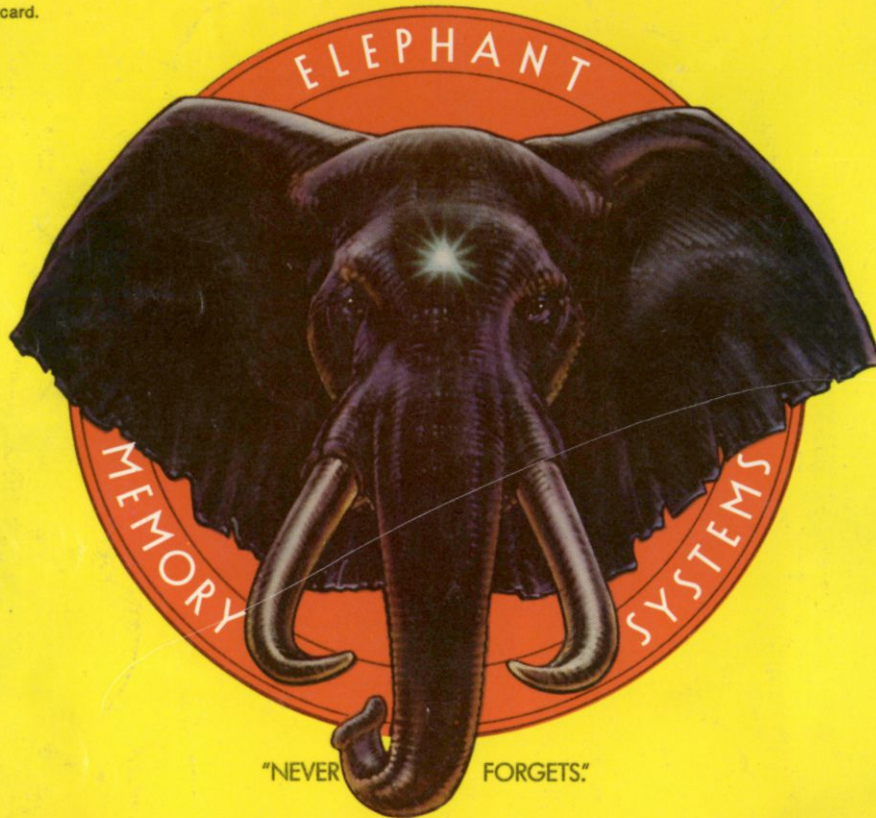

MORE THAN JUST ANOTHER PRETTY FACE.

Says who? Says ANSI.

Specifically, subcommittee X3B8 of the American National Standards Institute (ANSI) says so. The fact is all Elephant™ floppies meet or exceed the specs required to meet or exceed all their standards.

But just who is "subcommittee X3B8" to issue such pronouncements?

They're a group of people representing a large, well-balanced cross section of disciplines—from academia, government agencies, and the computer industry. People from places like IBM, Hewlett-Packard, 3M, Lawrence Livermore Labs, The U.S. Department of Defense, Honeywell and The Association of Computer Programmers and Analysts. In short, it's a bunch of high-caliber nitpickers whose mission, it seems, in order to make better disks for consumers, is also to

make life miserable for everyone in the disk-making business.

How? By gathering together periodically (often, one suspects, under the full moon) to concoct more and more rules to increase the quality of flexible disks. Their most recent rule book runs over 20 single-spaced pages—listing, and insisting upon—hundreds upon hundreds of standards a disk must meet in order to be blessed by ANSI. (And thereby be taken seriously by people who take disks seriously.)

In fact, if you'd like a copy of this formidable document, for free, just let us know and we'll send you one. Because once you know what it takes to make an Elephant for ANSI . . .

We think you'll want us to make some Elephants for you.

ELEPHANT.™ HEAVY DUTY DISKS.

For a free poster-size portrait of our powerful pachyderm, please write us.

Distributed Exclusively by Leading Edge Products, Inc., 225 Turnpike Street, Canton, Massachusetts 02021
Call: toll-free 1-800-343-6833; or in Massachusetts call collect (617) 828-8150. Telex 951-624.